

# Installation Manual

GreenField



# GreenField

## Irrigation Controller

Ag/MIS/UmEN-2733-05/19 Rev 1.9  
P/N: 116783



# GreenField

## Installation Manual

Rev 1.9, 06/2024

This manual for use and maintenance is an integral part of the apparatus together with the attached technical documentation.

This document is destined for the user of the apparatus: it may not be reproduced in whole or in part, committed to computer memory as a file or delivered to third parties without the prior authorization of the assembler of the system.

Munters reserves the right to effect modifications to the apparatus in accordance with technical and legal developments.

# Index

<i>chapter</i>		<i>page</i>
<b>1</b>	<b>INTRODUCTION .....</b>	<b>12</b>
1.1	Disclaimer.....	12
1.2	Introduction .....	12
1.3	Notes .....	12
<b>2</b>	<b>GENERAL INSTRUCTIONS.....</b>	<b>13</b>
2.1	Basic Requirements for On-Site Preparation .....	13
2.2	Frequency Inverters .....	13
2.3	General Dimensions .....	14
<b>3</b>	<b>POWER SUPPLY WIRING .....</b>	<b>15</b>
3.1	Main Power Wiring.....	15
3.2	Power Supply Options .....	17
3.2.1	Power Supply Option A.....	17
3.2.2	Power Supply Option B.....	17
3.3	Cold Start.....	18
3.4	Set Language, Time and Date.....	19
3.5	Electric Test .....	20
3.6	Firmware Update.....	21
3.6.1	Preliminary Information.....	21
3.6.2	Firmware – SD Card Compatibility .....	22
3.6.3	Preparing the SD Card.....	23
3.6.4	Accessing the Application.....	23
<b>4</b>	<b>ELECTRICAL INSTALLATION.....</b>	<b>25</b>
4.1	Input/Output .....	25
4.1.1	Layout .....	26
4.1.2	I/O Card Layout.....	26
4.1.3	Controller Hardware Verification .....	28
4.1.4	Input/Output Wiring .....	28
4.2	Output Terminal.....	29
4.2.1	Analog Output Card .....	29
4.2.1.1	Analog Output Card Installation.....	29
4.2.1.2	Analog Output Card Setup.....	29
4.2.2	24 VAC Connection.....	31
4.2.3	Dry Contact Card .....	32
4.2.3.1	Option 1 - Dry Contact Used as 24 VAC Output Card .....	32

4.2.3.2	Option 2 - Dry Contact Used as Normally Open Contact.....	33
4.3	Input Terminals.....	33
4.3.1	Wiring.....	33
4.3.2	Analog Input Card.....	35
4.3.2.1	Ech2o 5.....	36
4.3.2.2	Ech2o 5 Jumper Position.....	37
4.3.2.3	Analog Input Connection - Example: EC/pH Sensors.....	37
4.4	Expansion Unit Connection: Card Connection Options.....	38
4.4.1	RS-485 Connection.....	38
4.4.2	Wrong Relay Connection.....	40
4.4.3	Expansion Unit.....	40
4.4.3.1	Expansion Unit Settings.....	40
4.4.3.2	System Setup.....	41
4.4.4	PC and Inter-Controller Communication.....	41
4.4.4.1	Card Installation.....	42
4.4.4.2	Comm-Box Wiring.....	43
4.5	Controller Setup.....	45
4.5.1	Start-Up.....	45
4.5.2	Hardware Checklist.....	45
4.5.3	Output Definition.....	46
4.5.4	Digital Input Definition.....	46
4.5.5	Analog Input Definition.....	47
4.5.6	Analog Output Definition.....	47
4.6	Controller Test Procedure.....	48
4.6.1	Test Relays.....	48
4.6.2	Digital Input Test.....	49
4.6.3	Analog Input Test.....	49
4.6.4	Analog Output Test.....	50
4.6.4.1	Automatic Test.....	50
4.6.4.2	Manual Test.....	51
4.7	System Configuration Procedure.....	51
4.7.1	Device Delay Configuration.....	52
4.7.2	Pump Station Configuration.....	53
4.7.3	Valve Configuration.....	53
4.7.4	Valve Flow Rate Configuration.....	54
4.7.5	Water Meter Configuration.....	54
4.7.6	Dosing Channel Configuration.....	55
4.7.7	Analog Dosing Channel Configuration.....	55
4.7.8	Dosing Configuration.....	56
4.7.9	EC/PH Sensor Range.....	56
4.7.10	History Resolution.....	57

4.7.11	System Nutrigation™ Check .....	57
4.7.11.1	EC/pH IS ON Target .....	57
4.7.11.2	System Nutrigation Simulation .....	58
4.7.11.3	Water Run Time .....	58
4.7.11.4	Start/Stop Valve .....	58
4.7.12	Data Plug .....	59
<b>5</b>	<b>PROGRAM MENU .....</b>	<b>60</b>
5.1	Irrigation .....	61
5.1.1	Setting Irrigation that is Longer than 24H .....	64
5.2	Influence Program .....	65
5.2.1	Using the Influences .....	65
5.2.2	Setting the Influences .....	65
5.2.2.1	Radiation Influence on EC .....	66
5.2.2.2	Drainage Influence on Target Radiation Sum .....	67
5.2.2.3	Drain Influence on Minimum Time .....	68
5.2.2.4	Drainage EC Level Influence on Target EC .....	68
5.2.2.5	VPD Influence on Target EC .....	69
5.2.2.6	Temperature Influence on Target EC .....	70
5.3	Water Run Time .....	71
5.4	Dosing .....	72
5.4.1	Dosing Program .....	72
5.4.2	Dosing Injection Methods .....	73
5.5	Ext. Condition .....	74
5.5.1	Defining Analog Sensors .....	76
5.6	Agitator .....	76
5.7	Selector .....	77
5.8	Filter Flushing .....	77
5.9	Cooling .....	78
5.10	Misting .....	81
5.11	Water Heating .....	82
<b>6</b>	<b>MANUAL OPERATION MENU .....</b>	<b>83</b>
6.1	Irrigation Pause .....	83
6.2	Start/Stop Program .....	84
6.2.1	Start/Stop Valve .....	84
6.3	Filter Flushing .....	85
<b>7</b>	<b>ALARM MENU .....</b>	<b>86</b>
7.1	Alarm Reset .....	86
7.2	History .....	87
7.3	Alarm Definition .....	87
7.4	Alarm Setting .....	89

7.4.1	Analog Output Alarm Generation.....	89
7.5	EC/pH Alarm Definition.....	91
7.6	EC/pH Alarm Setting.....	91
7.7	Radio Sys. Alarm Definition.....	92
7.8	Radio Sys. Alarm View.....	92
<b>8</b>	<b>HISTORY MENU.....</b>	<b>94</b>
8.1	Irrigation Log.....	95
8.2	RAD. / VPD Sum & Drain Log.....	95
8.3	Uncompleted Irrigation.....	96
8.4	Uncompleted Programs.....	97
8.5	Daily Irrigation.....	97
8.6	Irrigation Accumulation.....	98
8.7	AUX Meter Accumulation.....	98
8.8	Accumulation Reset.....	99
8.9	Filters.....	99
8.10	Cooling.....	100
8.11	Sensors Log.....	100
8.12	Event Log.....	101
8.13	System Log.....	101
<b>9</b>	<b>TEST MENU.....</b>	<b>102</b>
9.1	Relays.....	102
9.2	Digital Input.....	103
9.3	Analog Input.....	104
9.4	Temperature.....	105
9.5	Humidity.....	105
9.6	Hardware Check List.....	105
9.7	Analog Output Test.....	106
<b>10</b>	<b>SETUP.....</b>	<b>107</b>
10.1	Time & Date.....	108
10.2	System Setup.....	108
10.3	Temperature Calibration.....	111
10.4	Humidity Calibration.....	112
10.5	EC/pH Calibration.....	112
10.5.1	Calibration of the EC/pH Monitor Transmitter.....	112
10.5.1.1	EC Calibration.....	112
10.5.1.2	pH Calibration.....	113
10.5.2	EC/pH Transmitter Monitor & GreenField Correlation.....	114
10.6	Pressure Calibration.....	115
10.7	Weather Station Calibration.....	115
10.8	Sensors Logging.....	115

10.9	Write to Data Plug.....	116
10.10	Read from Data Plug.....	117
<b>11</b>	<b>CONFIGURATION MENU .....</b>	<b>118</b>
11.1	Device Delay Configuration .....	119
11.1.1	Example of Device Startup & Shutdown Order .....	119
11.1.2	Example of Stagger Valve Delay – Multiple Shifts.....	121
11.2	Pump Station Configuration.....	122
11.3	Valve Configuration .....	123
11.4	Valve Flow Rate.....	124
11.5	Water Meter .....	125
11.6	Dosing Channel Configuration .....	126
11.6.1	Calibrating the Analog Dosing Valves.....	127
11.6.2	Calibrating the Venturi Pumps .....	129
11.7	Dosing Configuration .....	131
11.8	EC Pre-Control Configuration.....	132
11.9	Drainage Configuration.....	133
11.10	System Pressure Configuration.....	133
11.11	EC/pH Range Definition.....	134
11.12	Pressure Sensor Range Definition.....	134
11.13	Cooling Configuration.....	134
11.14	Misting Configuration .....	135
<b>12</b>	<b>INSTALLATION MENU .....</b>	<b>136</b>
12.1	Device Layout .....	136
12.2	Device List.....	138
12.3	Digital Input.....	138
12.4	Analog Input 1-2.....	139
12.5	Analog Output.....	142
12.6	Hardware Checklist .....	142
<b>13</b>	<b>CONTROLLER ADVANCED SETTINGS .....</b>	<b>143</b>
13.1	Pump Station Configuration.....	143
13.2	Multiple Water Meters .....	143
13.2.1	Option A - Standard Use/Measurement.....	144
13.2.2	Option B - Multiple Water Sources .....	144
13.3	Drain Meter Measurement.....	145
13.3.1	Drainage Timing Option A.....	145
13.3.2	Drainage Timing Option B.....	146
13.4	Various Dosing Channel Configurations.....	146
13.4.1	Method 1.....	146
13.4.2	Method 2 .....	147
13.4.3	Method 3 .....	147

13.5	Dosing Configuration .....	148
13.6	Dual EC/pH Sensors.....	148
13.7	Hot Keys and Status Screens.....	150
13.8	Operation Mode.....	151
<b>14</b>	<b>APPENDIX A – GREENFIELD PARTS LIST.....</b>	<b>153</b>
<b>15</b>	<b>APPENDIX B – TROUBLESHOOTING.....</b>	<b>155</b>
15.1	Controller Malfunction.....	155
15.2	Burnt Fuse - In Case of Voltage .....	155
<b>16</b>	<b>APPENDIX C – REPLACEMENTS AND ADDITIONAL INSTALLATIONS.....</b>	<b>156</b>
16.1	Installing a 24 VAC Output Card.....	156
16.2	Removing a Card .....	157
16.3	Adding a Dry Contact Output Card .....	157
16.4	Adding an Input Card.....	158
16.5	LCD & Keyboard Replacement .....	159
<b>17</b>	<b>APPENDIX D – SENSOR INSTALLATION AND DEFINITION.....</b>	<b>160</b>
17.1	EC – pH Sensor Connection.....	160
17.1.1	EC Sensor Calibration.....	161
17.1.2	pH Sensor Calibration.....	162
17.1.3	GreenField pH Calibration.....	164
17.2	Measuring Box Connection .....	165
17.3	Humidity Sensor Definition.....	166
17.3.1	Outside Temperature/Humidity Sensor Connection .....	167
17.3.2	Sensor Definition.....	167
17.4	Pyranometer Connection – GreenField.....	168
17.5	Radiation Sensor Definition .....	169
17.5.1	Radiation Sensor Configuration – Munters .....	169
17.5.2	Radiation Sensor Connection – Davis .....	170
17.5.2.1	Radiation Sensor Definition .....	170
17.5.2.2	Radiation Sensor Configuration - Option B- Davis.....	171
17.6	Pressure Transducer Connection .....	172
17.6.1	Analog Pressure Sensor Definition .....	172
17.7	Wind Direction Connection.....	173
17.7.1	Wind Direction Sensor Definition.....	174
17.7.2	Wind Speed Digital Input Definition.....	174
17.8	Sensor and Cable Specifications .....	175
<b>18</b>	<b>APPENDIX E- TECHNICAL SPECIFICATIONS .....</b>	<b>177</b>
18.1	Technical Specifications.....	177
18.2	Controller Components .....	177
18.2.1	Keyboard & Display .....	178
18.2.2	CPU.....	178



18.2.3	Power Supply .....	178
18.2.3.1	Power Supply Circuit Drawing.....	179
18.2.3.2	Power Supply Fuse Protection .....	180
18.2.3.3	Output.....	180
18.2.4	Digital Input.....	181
18.2.5	Analog Input .....	181
18.2.6	Analog Output.....	181
19	<b>APPENDIX F - MAIN MENU TREE .....</b>	<b>182</b>
20	<b>WARRANTY .....</b>	<b>183</b>

# 1 Introduction

## 1.1 Disclaimer

Munters reserves the right to make alterations to specifications, quantities, dimensions etc. for production or other reasons, subsequent to publication. The information contained herein has been prepared by qualified experts within Munters. While we believe the information is accurate and complete, we make no warranty or representation for any particular purposes. The information is offered in good faith and with the understanding that any use of the units or accessories in breach of the directions and warnings in this document is at the sole discretion and risk of the user.

## 1.2 Introduction

Congratulations on your excellent choice of purchasing a GreenField Controller!

In order to realize the full benefit from this product it is important that it is installed, commissioned and operated correctly. Before installation or using the fan, this manual should be studied carefully. It is also recommended that it is kept safely for future reference. The manual is intended as a reference for installation, commissioning and day-to-day operation of the Munters Controllers.

## 1.3 Notes

Date of release: July 2019

Munters cannot guarantee to inform users about the changes or to distribute new manuals to them.

All rights reserved. No part of this manual may be reproduced in any manner whatsoever without the expressed written permission of Munters. The contents of this manual are subject to change without notice.

# 2 General Instructions

- Installation should be performed by authorized technicians only.
- Verify that field components are working properly.
- Apply all safety regulations.
- Do not apply force or pressure on components during the installation procedure.
- Refer to your supervisor if problems occur during installation procedure.

## 2.1 Basic Requirements for On-Site Preparation

- Verify power source between 115 VAC or 220 VAC. (Australia & New Zealand 240 VAC  $\pm 5\%$ ).
- On the unit is a silver label stating the unit's voltage (110 or 230 VAC). Verify that your unit supports the voltage supplied in your country.
- Verify grounding connection  $< 10\Omega$ .
- Environment temperature between ( $-10^{\circ}\text{C} / 14^{\circ}\text{F}$ ) to ( $+60^{\circ}\text{C} / 140^{\circ}\text{F}$ ).
- Verify protection from damaging climate conditions.

## 2.2 Frequency Inverters

Frequency inverters can cause severe electrical and electromagnetic interference. Therefore, when employing a frequency inverter, it is critical that you carefully follow the manufacturer's installation instructions.

In particular verify:

- that the cable shielding between the inverter and any motor meets industry standards
- proper grounding of the inverter's chassis and motor power cable
- proper grounding of low voltage cable shield wire
- that the controller and inverter cables are kept in separate conduits or wire bundles

2.3 General Dimensions

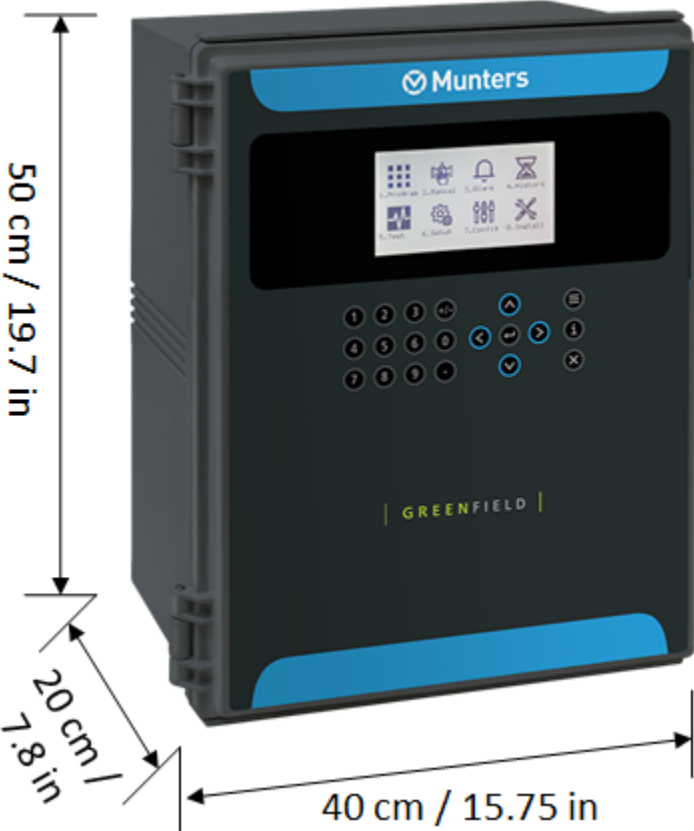



# 3 Power Supply Wiring

- Main Power Wiring, page 15
- Power Supply Options, page 17
- Cold Start, page 18
- Set Language, Time and Date, page 19
- Electric Test, page 20

## 3.1 Main Power Wiring

**CAUTION! SHOCK HAZARD! The electrical installation should be performed by a qualified electrician only!**

**1**  **SWITCH OFF** Main power  
 **VERIFY** grounding connection <math>< 10\Omega</math>



**2**  **LOOSEN** Gland screw

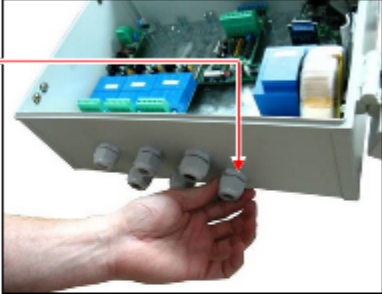

**3**  **INSERT** Feeding cable into Gland cover

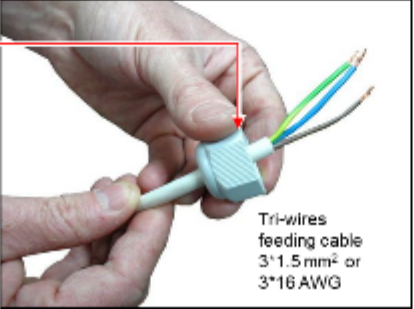

Tri-wires feeding cable  
3\*1.5 mm<sup>2</sup> or  
3\*16 AWG

 **NOTE:** There are two wiring options according to the sticker attached to the side wall of the controller:  
115 VAC 50-60Hz or 230VAC 50-60 Hz





**4**   Cable into gland screw

 Cable length to reach the terminal connector location



**5**   Gland cover





**6**   As followed:

 **CAUTION! SHOCK HAZARD!** The electrical installation should be performed by a qualified electrician only!

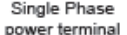
Grounding terminal 

Single Phase power terminal 

**6.1**  Wires accordingly:  
 Grounding wire to grounding terminal  
 Neutral wire (blue) to neutral in connector terminal  
 Phase wire (brown) to line in connector terminal

**6.2**  Grounding terminal screws x1  
 Phase and Neutral connectors screws x2

 Wire colors in USA:  
 Black=Phase  
 White=Common  
 Green=Ground  
 Neutral=Common (USA)

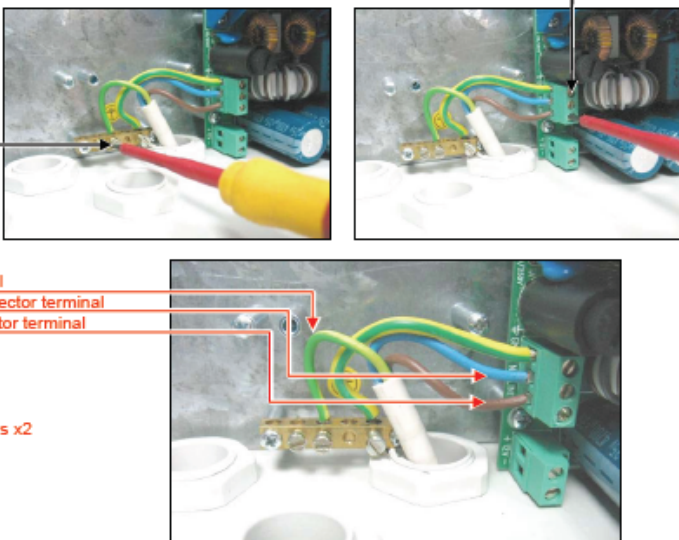

## 3.2 Power Supply Options

- Power Supply Option A
- Power Supply Option B

### 3.2.1 POWER SUPPLY OPTION A

In case of remote consumers or low voltage on the main power, there is an option to use a 29 VAC supplier as shown:

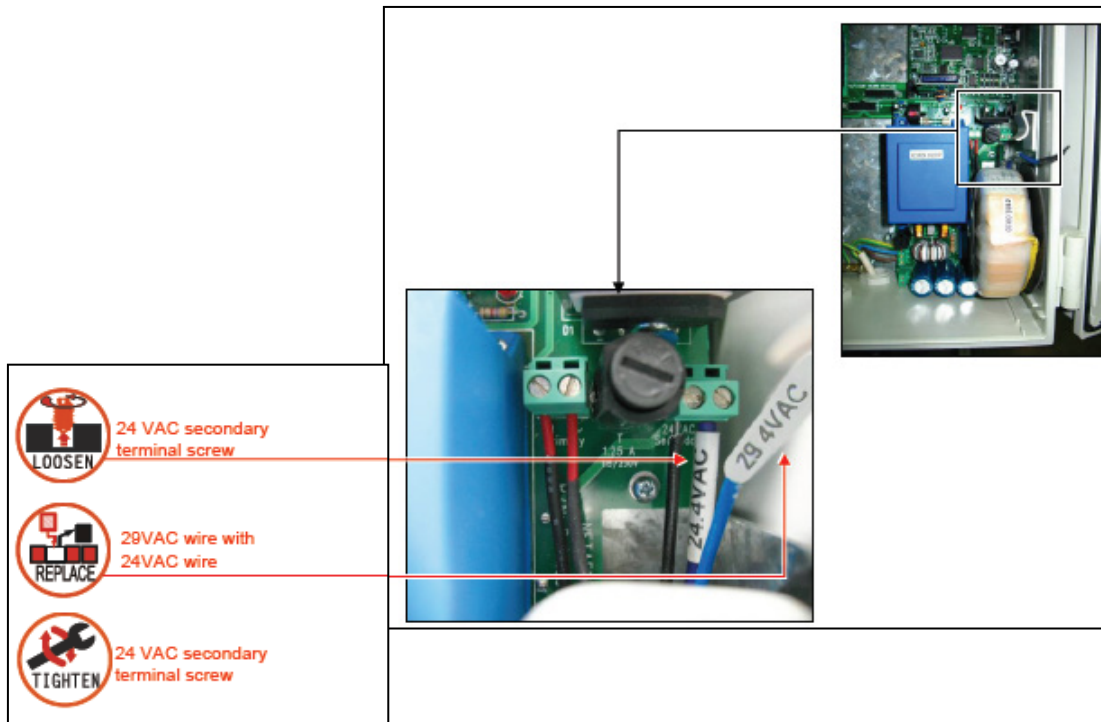

### 3.2.2 POWER SUPPLY OPTION B

In case of voltage discrepancy or fluctuation in the main voltage, there is an option of connecting the system to an independent supplier and keeping the main voltage as power source for the output devices as shown:

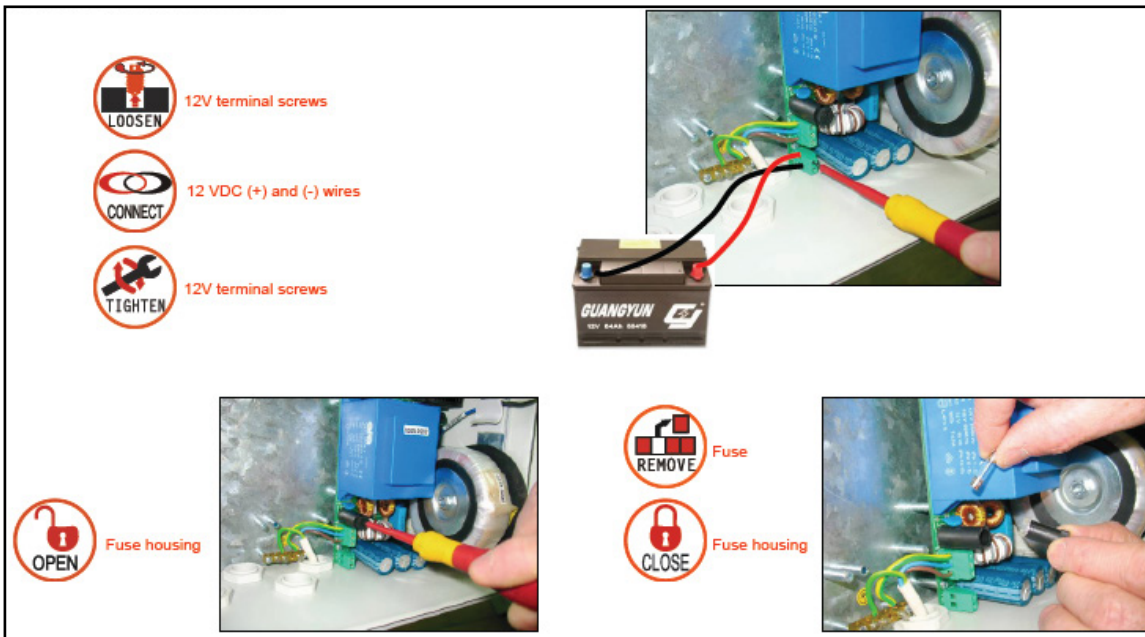

### 3.3 Cold Start

**NOTE** To perform a cold start or firmware upgrade, the controller must be in the "Technician" mode; refer to the Controller Advanced Settings - Operation Mode.

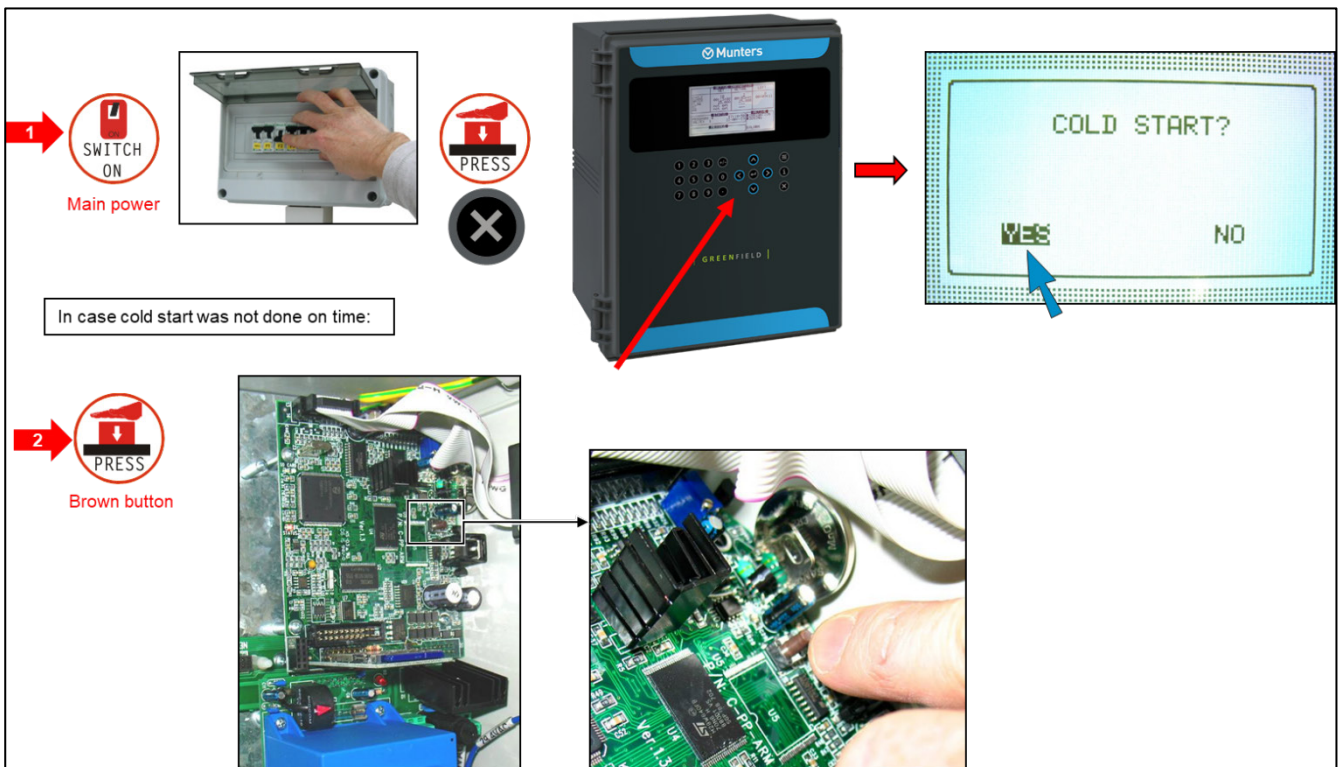



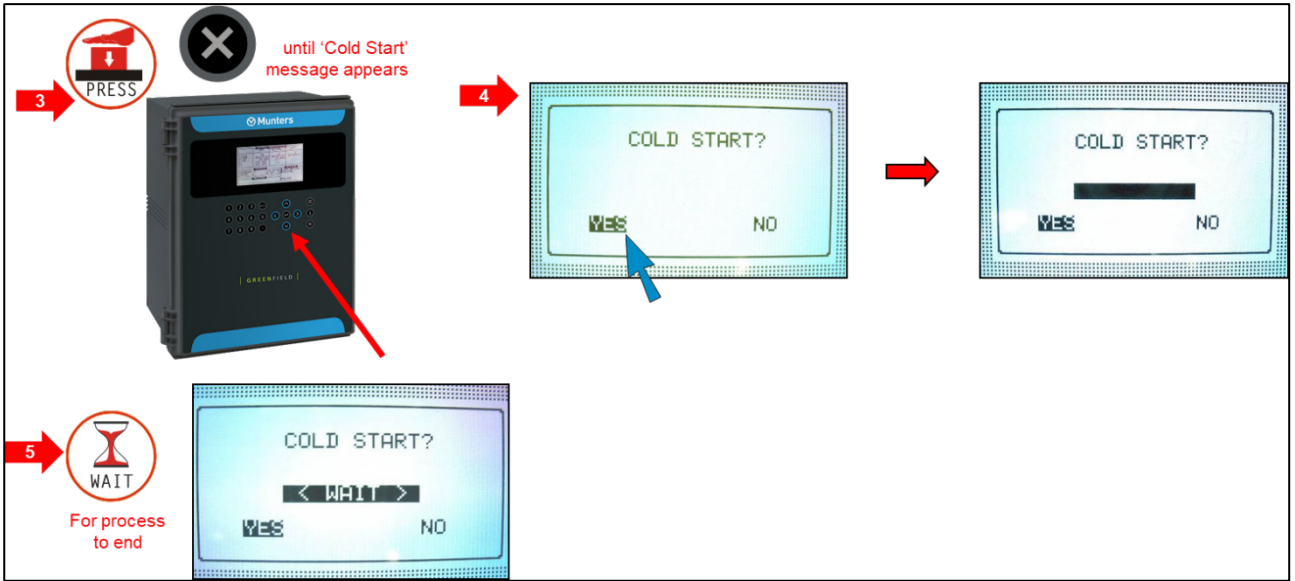

### 3.4 Set Language, Time and Date

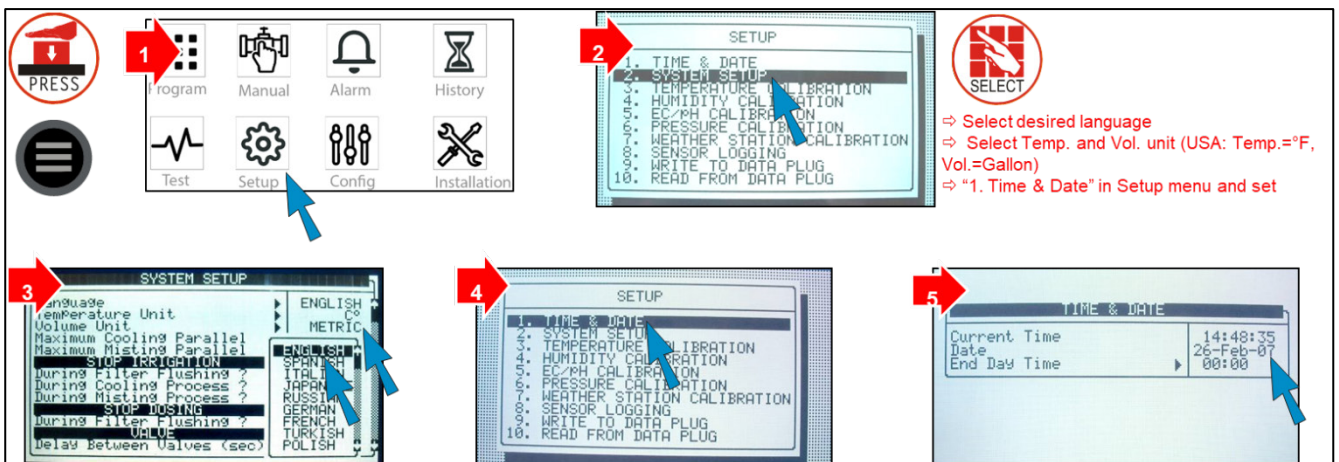

**NOTE** In any given menu, you can use arrow and ENTER keys on the touch pad to make a selection, or press the corresponding number and ENTER on touch pad as a short cut.

### 3.5 Electric Test

**1** →

**PERFORM** Electrical test with Multimeter

**CAUTION! SHOCK HAZARD! The electrical installation should be performed by a qualified electrician only!**

**2** →

**CHECK** ⇒ Phase to ground  
⇒ Phase to neutral

**ENSURE**

Phase to ground results:  
Option 1- 220VAC± 10 % (EUR, AFR)  
Option 2- 115VAC±10% (USA, MEX)  
Option 3- 240VAC±5% (AUS, NZ)

Phase to neutral results:  
Option 1- 220VAC± 10 % (EUR, AFR)  
Option 2- 115VAC±10% (USA, MEX)  
Option 3- 240VAC±5% (AUS, NZ)

**3** →

**PERFORM** Electrical test with multimeter of secondary voltage for output devices

**ENSURE** Result 24VAC ±10%

## 3.6 Firmware Update

This section details the software upgrade procedure, starting from determining which SD card is compatible.

The Bootloader application enables updating the system firmware. The application is menu based and simple to use and enables updating the firmware from an SD card. Due to changes made by SD card manufacturers in newer cards, there is a compatibility issue between these cards and the ARM CPU boot section software (the software used when upgrading the controller firmware). The card is found inside the ARM CPU.

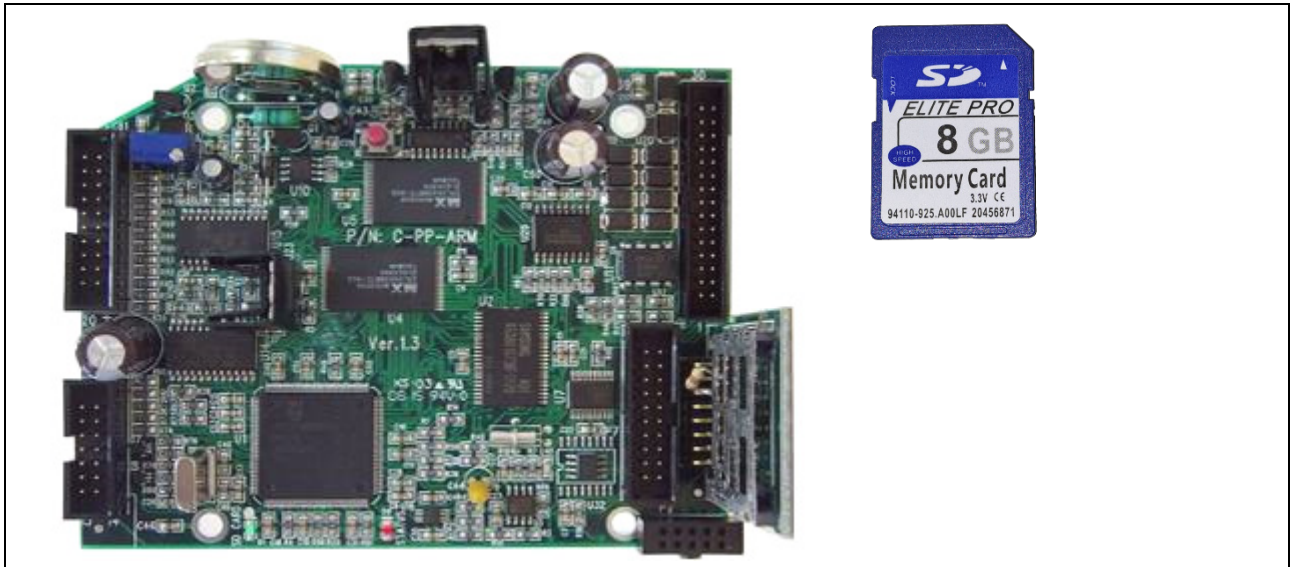

Because of this incompatibility, the procedure suspends itself and an error message appears: SD CARD NOT FOUND. (In certain cases, the process can simply suspend itself with no message given.)

**CAUTION** If the upgrade process fails, contact Munters technical support regarding an RMA.

### 3.6.1 PRELIMINARY INFORMATION

- Munters strongly recommends having a spare CPU on site, in case the upgrade fails.
- Before upgrading, store the controller's setting on a data plug (refer to Write to Data Plug).
- After upgrading, upload the controller's setting from a data plug (refer to Read from Data Plug).
- While upgrading the firmware, a qualified Munters technician:
  - must be on-site.
  - must verify that the process is complete; verification includes checking all accessories connected to the controller.
    - In the event that the controller sends a message regarding incomplete information, the technician must enter the missing information manually and verify that the information is correct while in the field.
- By default, in all sessions the controller returns to **automatic mode**. The technician must verify that there are no **manual mode** devices in the field.



**CAUTION** Any upgrade that is not performed in accordance with these guidelines could result in unforeseen malfunctions in the field equipment. Munters will not take responsibility for these issues.

### 3.6.2 FIRMWARE – SD CARD COMPATIBILITY

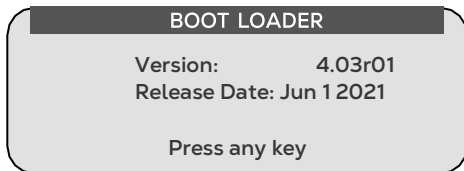
1. On the CPU Card, press the red **Reset** button.
2. While the CPU is restarting press and hold down the **DOWN** and **LEFT** arrows button on the front display panel. The screen displays the Boot Version for a few seconds.



There are three version types. The following table details which SD card must be used with each version.

<p>ARM CPU Card, Software Version 4.03.0 supports “older SD cards” only</p>	
<p>ARM CPU Card, Software Version 4.03.1 supports “newer SD cards” cards only.</p>	
<p>ARM CPU Card, Software Version 4.03.2 supports “newer SD cards” cards only.</p>	
<p>Both “old” and “new” type SD cards have the same PN, but the date code on the bottom right corner differs.  “New” type SD cards are dated with Year 2020 or later (first 2 digits; see below)</p>	



### Summary

Boot Version type	SD type-Old	SD type-New	Notes
4.03.01 or higher	V	V	
4.03.00 or lower	V	--	

### 3.6.3 PREPARING THE SD CARD

1. Remove the SD card from the ARM CPU and place it in a standard SD card reader.
2. From your computer, paste the firmware (GRFT30809\_A.hex) onto the card (meaning: do not place the file in a directory).
3. Place the SD card back in the ARM CPU.

### 3.6.4 ACCESSING THE APPLICATION



**NOTE** Pressing  takes you to the previous menu.

1. Press and hold the Left and Down arrow keys.
2. Turn on the unit.

In the screen that appears, enter the password: **1948**. The following screen appears.

**NOTE** If you enter the wrong password, an error message appears and the program goes to the Main Screen. Repeat the process.

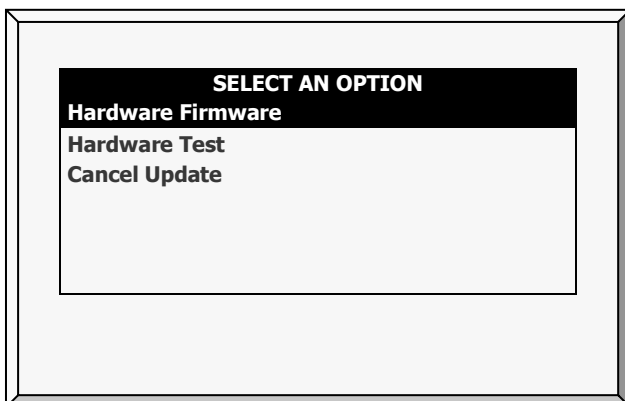

**NOTE** Hardware Test is used for quality control only.

3. Select Hardware Firmware. The following screen appears (example only):

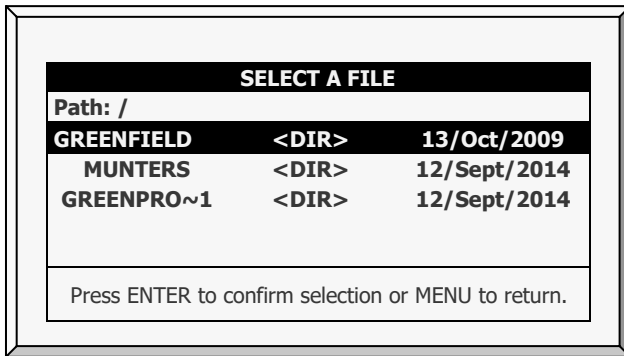

4. Select the required file.

5. Press .

6. A confirmation message appears. Select Yes.

7. Press .

*NOTE Do not turn the unit off during the update! If there is an interruption (for example a power outage), restart the process.*

At the end of the process, the following screen appears (the version numbers are examples only):



8. Press  and perform a Cold Start.

# 4 Electrical Installation

- [Input/Output, page 29](#)
- [Output Terminal, page 29](#)
- [Input Terminals, page 33](#)
- [Expansion Unit Connection: Card Connection Options, page 38](#)
- [Controller Setup, page 45](#)
- [Controller Test Procedure, page 47](#)
- [System Configuration Procedure, page 50](#)

## 4.1 [Input/Output](#)

- [Layout, page 26](#)
- [I/O Card Layout, page 26](#)
- [Controller Hardware Verification, page 28](#)
- [Input/Output Wiring, page 28](#)

## 4.1.1 LAYOUT

The following diagram is an example setup of an GreenField board. Actual boards may differ.

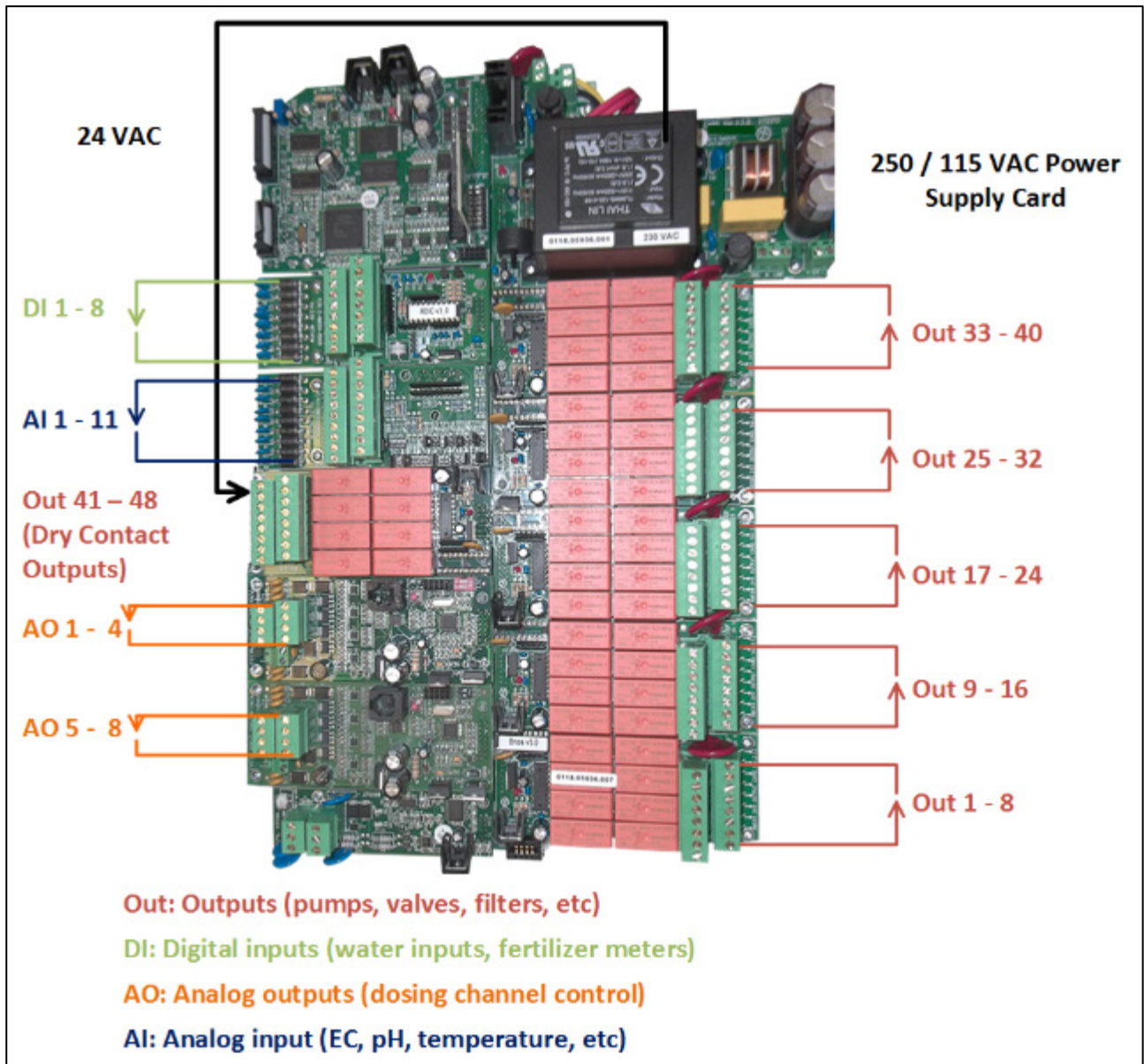

## 4.1.2 I/O CARD LAYOUT

Modular I/O Bus:

- Up to 10 I/O Cards
- 5 I/O Card Options
  - 24 VAC Output Card
  - Dry Contact Output Card
  - SingleNet Dummy Card
  - Digital Input card
  - Analogue Input Card
  - Analog Output Card



- LED Status Lights for:
  - 24 VAC Output Card
  - Dry Contact Output Card
  - Digital Input Card
  - SingleNet Dummy Output Card

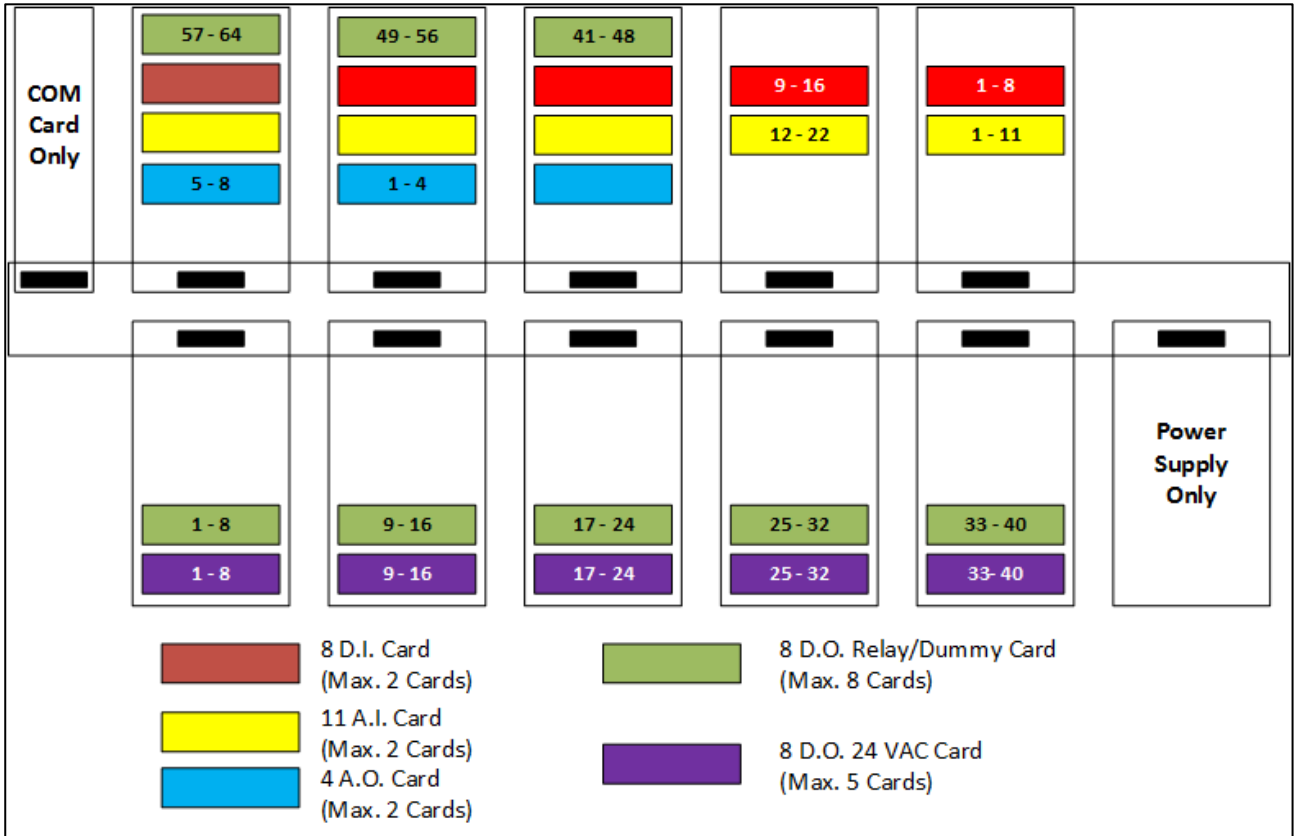

NOTE The diagram above is an example setup. Actual setups may differ.

NOTE Analog Output Cards must be installed in the slots shown above.

### 4.1.3 CONTROLLER HARDWARE VERIFICATION

**SELECT**

⇒ "8. Install"

⇒ "6. Hardware checklist"

**1**

Program

Manual

Alarm

History

Test

Setup

Config

Installation

**2**

INSTALLATION

1. DEVICE LAYOUT
2. DEVICE LIST
3. DIGITAL INPUT
4. ANALOG INPUT 1
5. ANALOG INPUT 2
6. ANALOG OUTPUT
7. **HARDWARE CHECKLIST**

**3**

HARDWARE CHECKLIST					
DESCRIPTION	LOC.	EXP1	EXP2	EXP3	
Analog Input	1	-	-	-	
Digital Input	1	-	-	-	
Relay Card	1	-	-	-	
EXP - Box Location	-	-	-	-	
Digital Output	-	-	-	-	
COM.	A. Out No. 2	A. Out No. 1	D. In No. 2	A. In No. 1	D. In No. 1
Relay 1+ 8	Relay 9+16	Relay 17+24	Relay 25+32	Relay 33+40	P.S.

**Legend**

**COM.** - Communication card location

**Relay** - 24VAC or dry contact output

**R.U** - Remote Unit output

**A.In** - Analog input card

**D.In** - Digital input card

**P.S** - Power supply

**ENSURE**  
Hardware OK

**SWITCH OFF**

Main power



### 4.1.4 INPUT/OUTPUT WIRING

**REMOVE**

Wire Channel Cover

**CONNECT**

Wires as shown

**LOOSEN**

Screw as shown

**INSERT**

Wire

**ROUTE**

Wires:  
Low terminal=command  
High terminal=common

**SCREW**

Until wire is locked inside bracket

**ROUTE**

Wires through Wire Channel



**REPEAT**

Perform the above steps for all wires

## 4.2 Output Terminal

- Analog Output Card
- 24 VAC Connection
- Dry Contact Card

### 4.2.1 ANALOG OUTPUT CARD

- Analog Output Card Installation
- Analog Output Card Setup

#### 4.2.1.1 Analog Output Card Installation

1. Verify the following before installing the cards:
  - GreenField Controller firmware is Version 3.7.02 or above
  - Green Net Version: 4.07.18
2. Disconnect the controller from the power.
3. Install the analog cards in the slots indicated in I/O Card Layout, page 26.
4. Apply power; the GreenField will detect the new card(s).
5. In the screen that appears, select YES.



6. Go to the Installation Menu to confirm that the card is installed.

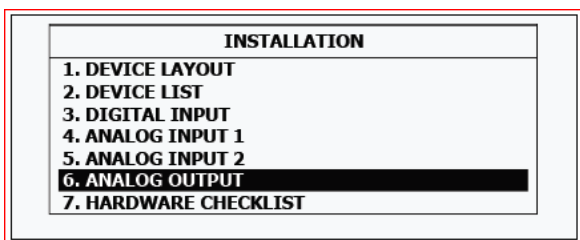

#### 4.2.1.2 Analog Output Card Setup

To install the Analog Output Card (refer to the following diagrams):

- wire the card
- set the dipswitches



- 1 & 2: Voltage supply, 24 VAC (Red and Black wires)
- 3: COM Port (Yellow wire)
- 4: OUT Ports 1 – 4 (4 – 20 mA) (Blue wire)
- 5: Valve
- 6: Dipswitches (see below)

**NOTE** Each card can support up to four valves. Connect each valve to a different Output; one COM port can support up to four devices.

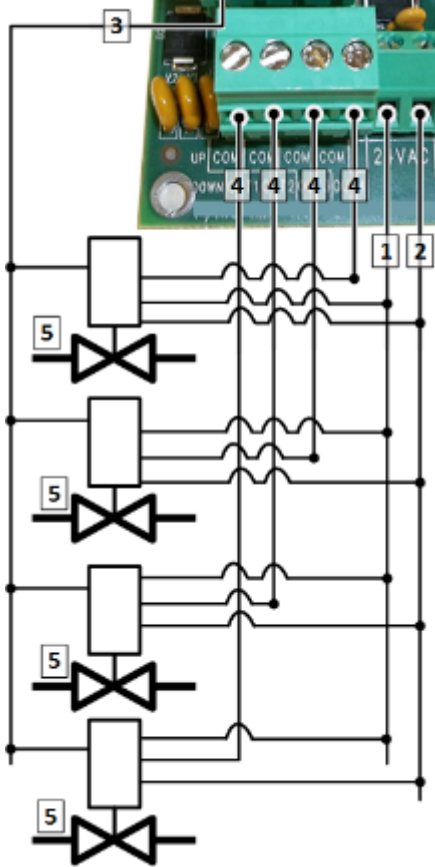

- When using an analog dosing valve make sure the dosing valve selector is in the AUTO position.

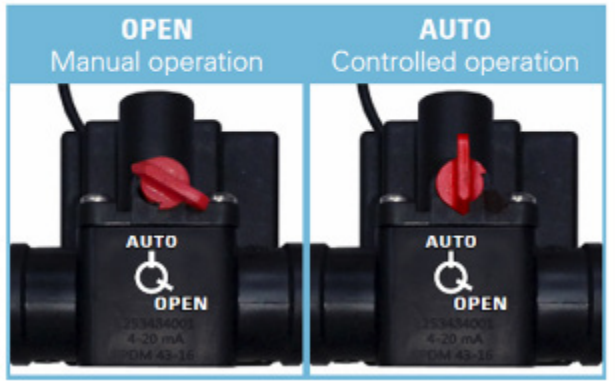

Use the dipswitches (#6 in the above illustration) to define a card as Card One or Card Two. This is needed to ensure that the Controller can properly manage analog output devices.

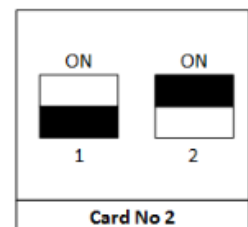
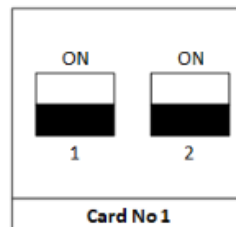

**NOTE** Refer to Analog Dosing Channel Configuration, page 55.

## 4.2.2 24 VAC CONNECTION

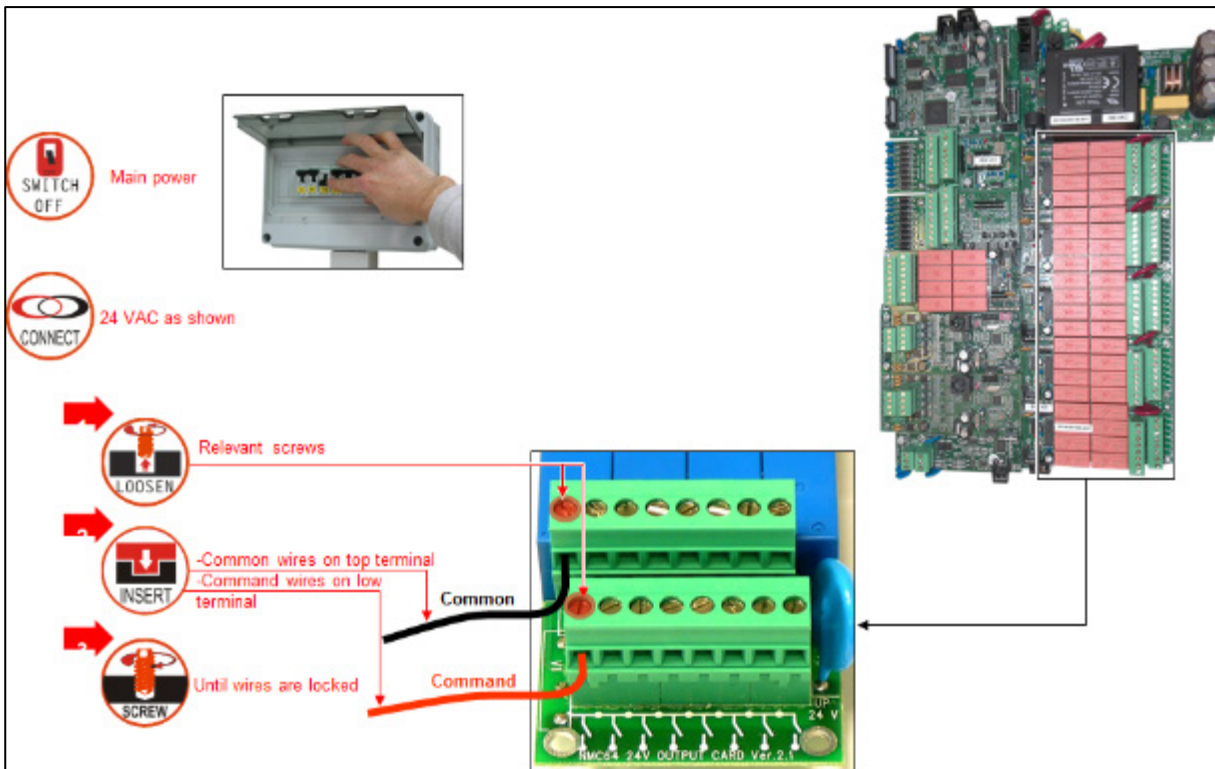

24VAC OUTPUT CARD CONNECTION- EXAMPLE

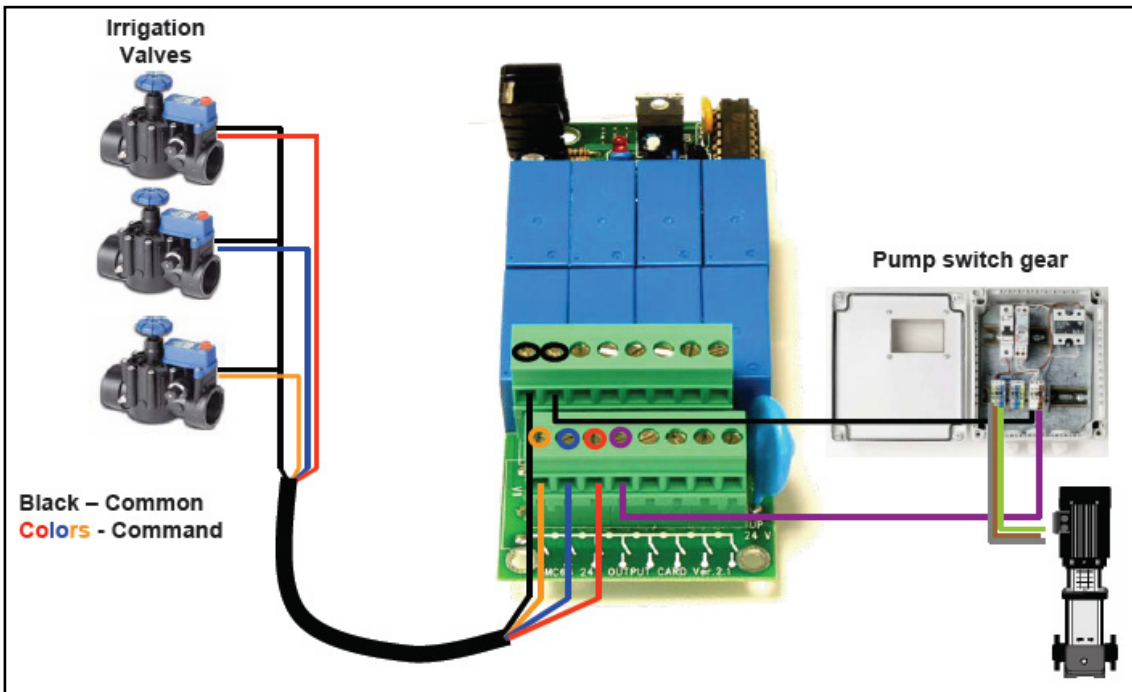

## 4.2.3 DRY CONTACT CARD

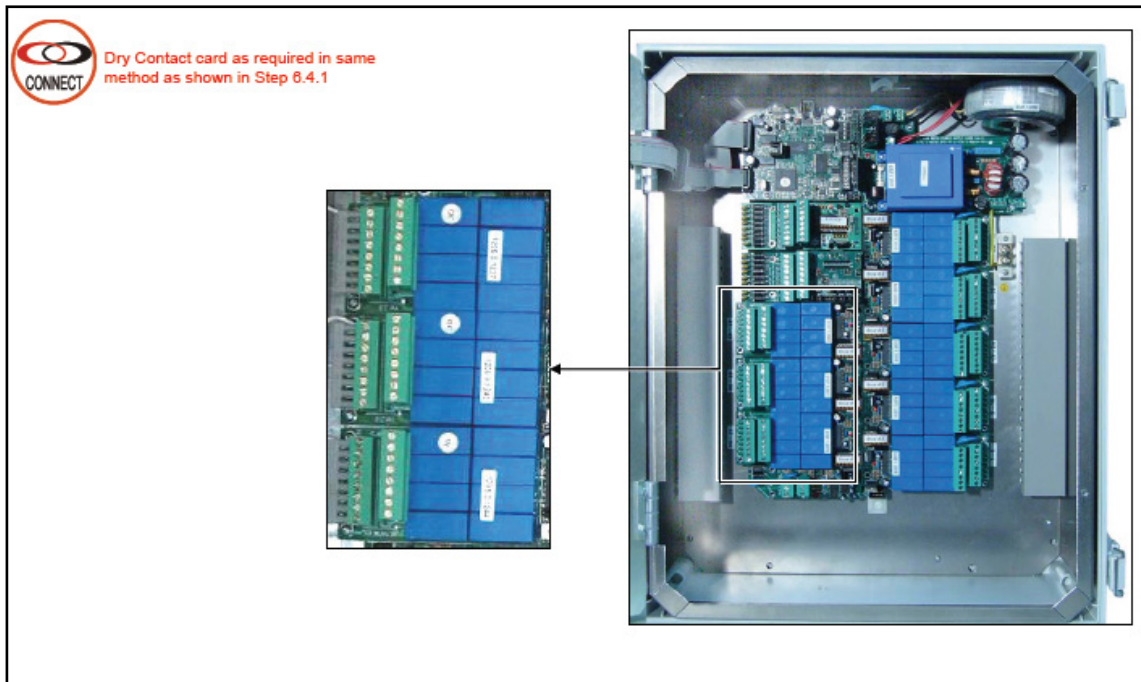

- Option 1 - Dry Contact Used as 24 VAC Output Card
- Option 2 - Dry Contact Used as Normally Open Contact

### 4.2.3.1 Option 1 - Dry Contact Used as 24 VAC Output Card

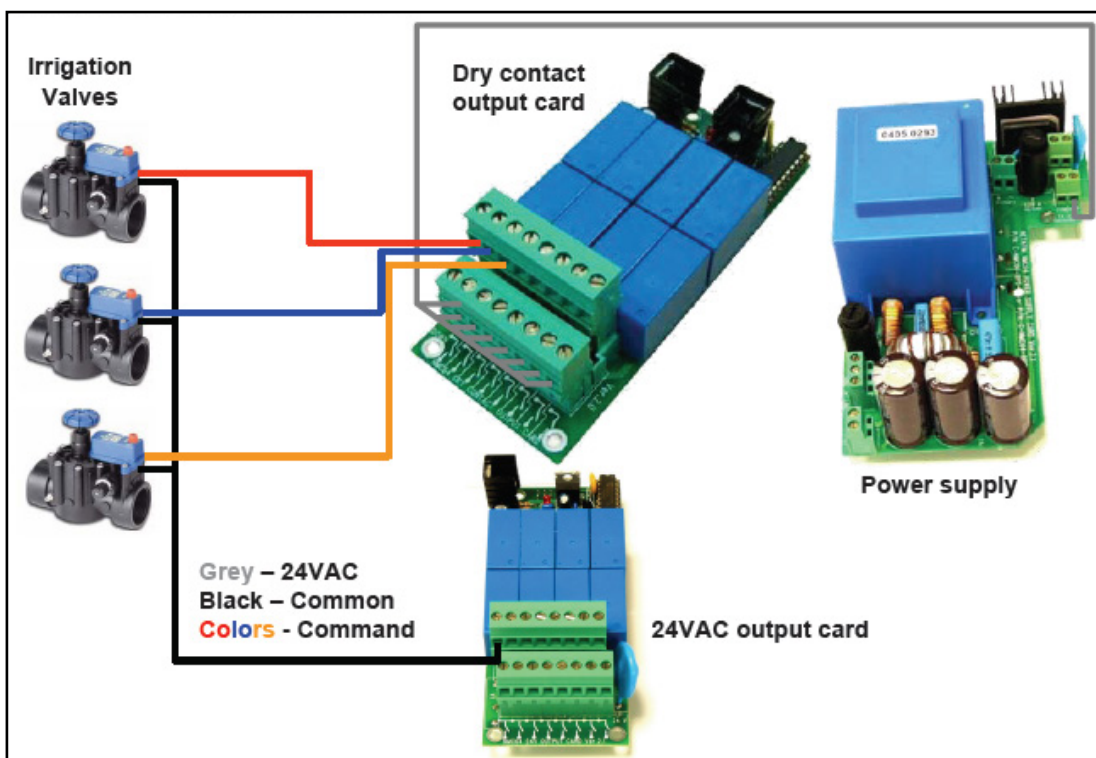

### 4.2.3.2 Option 2 - Dry Contact Used as Normally Open Contact

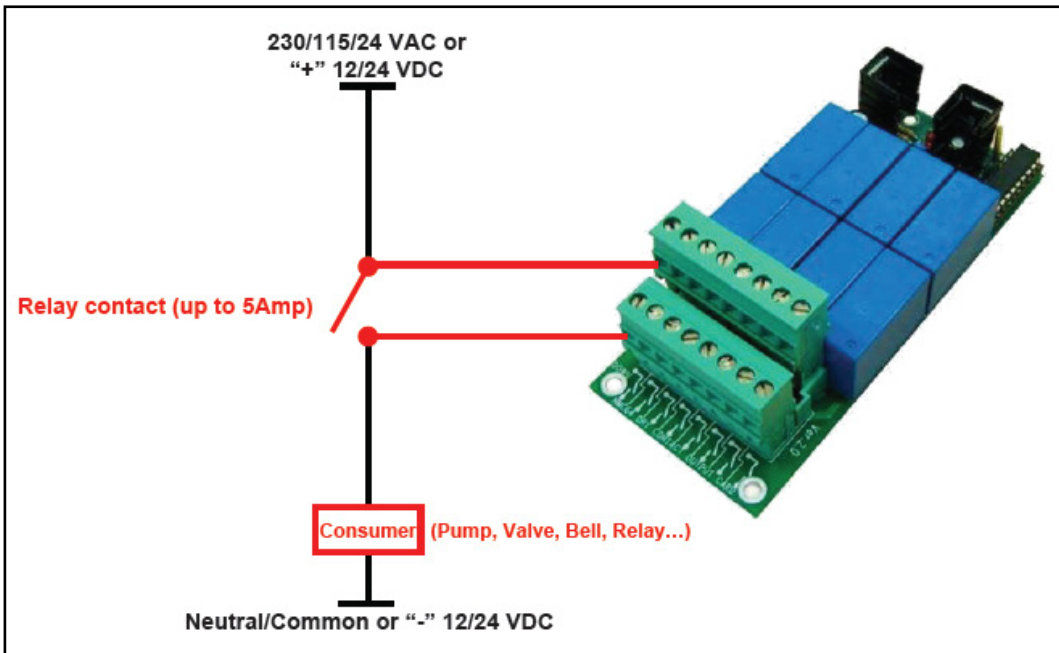

## 4.3 Input Terminals

- Wiring, page 33
- Analog Input Card, page 35

### 4.3.1 WIRING

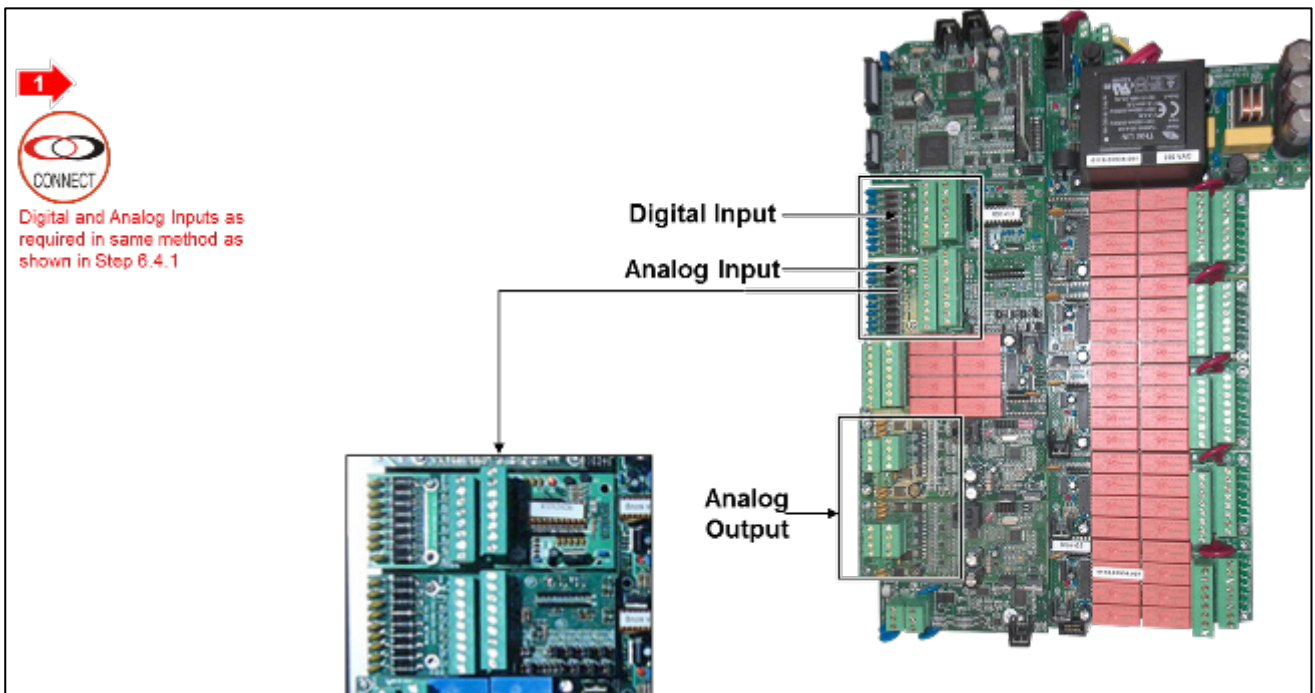

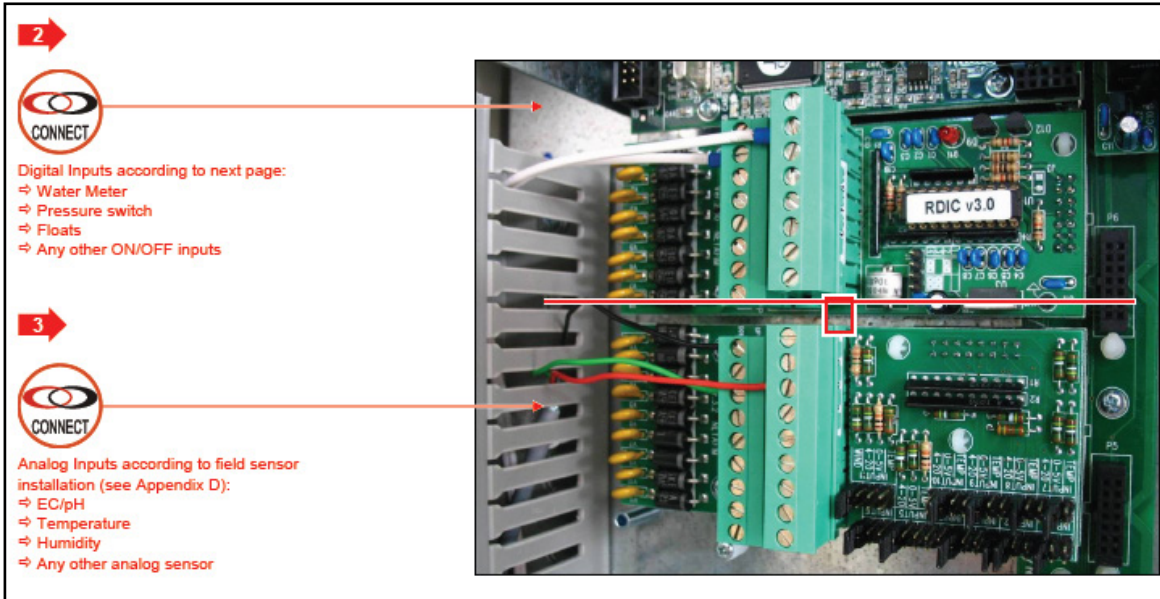

### Digital Input Connection Examples

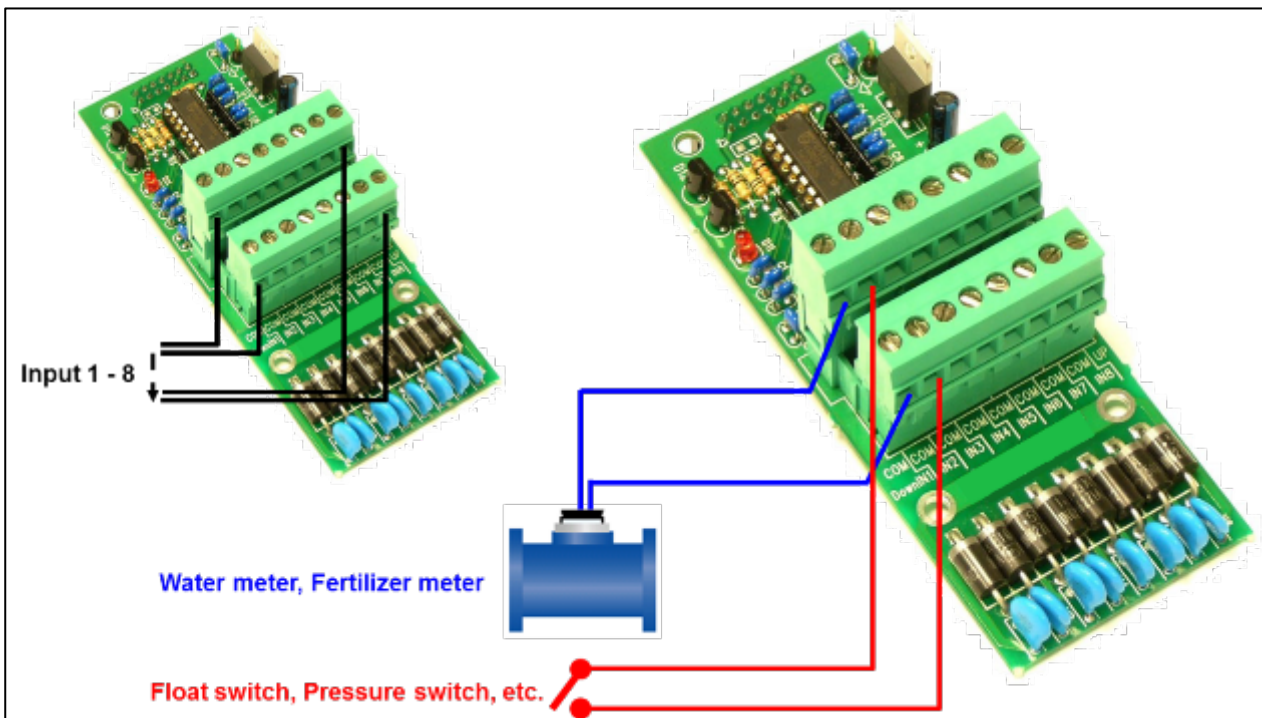



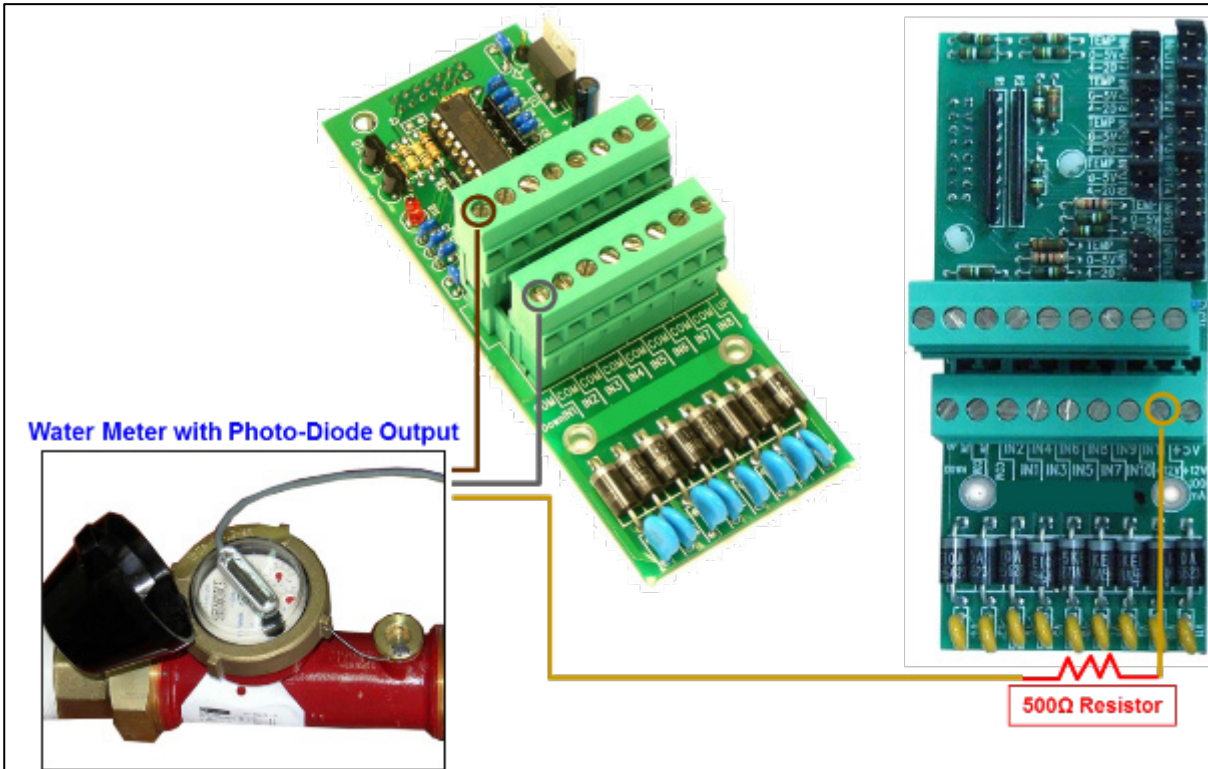

### 4.3.2 ANALOG INPUT CARD

- The analog input card includes 11 x analog inputs.
- The type of every input can be selected by jumper positioning.

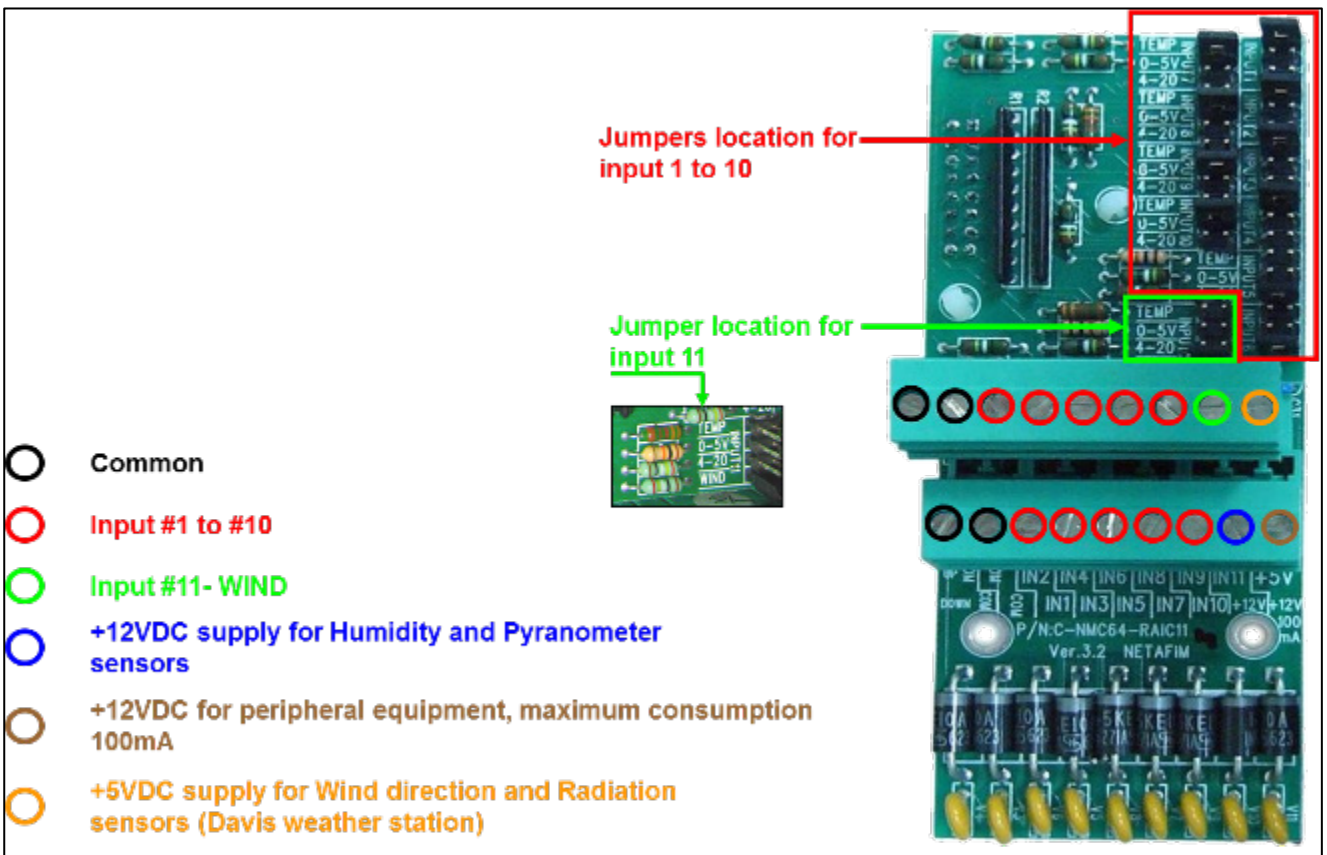

- Ech2o 5, page 36

### 4.3.2.1 Ech2o 5

- Ech2o 5 Specifications
- Ech2o 5 Installation

#### 4.3.2.1.1 Ech2o 5 Specifications

- Measurement Time: 10 ms (milliseconds)
- Accuracy: at least 0.03 m<sup>3</sup>/m<sup>3</sup> all soils, up to 8 dS/m with soil-specific calibration: ±.02 m<sup>3</sup>/m<sup>3</sup> (±2%)
- Resolution: 0.001 m<sup>3</sup>/m<sup>3</sup> VWC in mineral soils, 0.25% in growing media
- Power Requirements: 2.5VDC - 3.6VDC @ 10mA
- Output: 10-40% of excitation voltage (250 - 1000mV at 2500 mV excitation)
- Operating Environment: -40° to +60° C
- Range of Measurement: 0 to saturation
- Sensor Dimensions (cm): 8.9 W x 1.8 D x 0.7 L

#### 4.3.2.1.2 Ech2o 5 Installation

Connect as follows:

- Red: to inputs 1 – 11; jumper 0 – 5V (In the picture below, Red is attached to Terminal 9.)
- Black to +5V
- Bare to COM

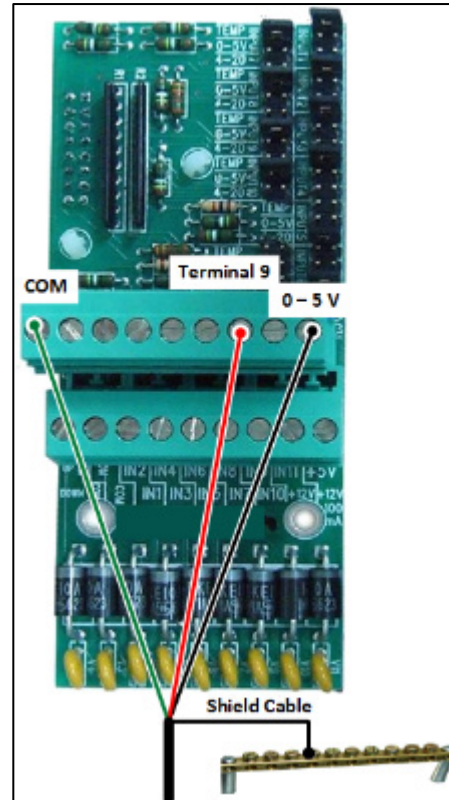

**CAUTION** TO ENSURE INTERFERENCE AND LIGHTNING IMMUNITY, USE SHIELDED CABLE ONLY (22 AWG MINIMUM)!

**CAUTION** POWER AND SIGNAL WIRES MUST BE IN SEPARATE CABLES!

### 4.3.2.2 Ech2o 5 Jumper Position

When installing the Ech2o 5, place the jumper on the 0 – 5 V terminals of the required channel position.

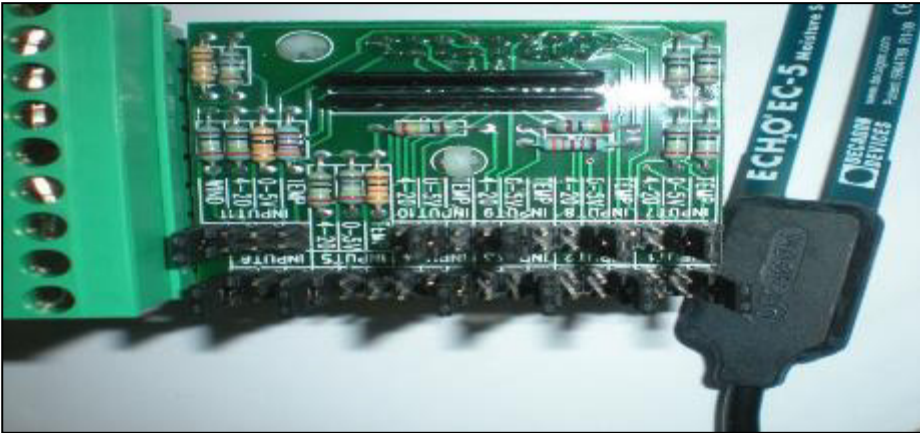

### 4.3.2.3 Analog Input Connection - Example: EC/pH Sensors

NOTE See [Appendix D](#).

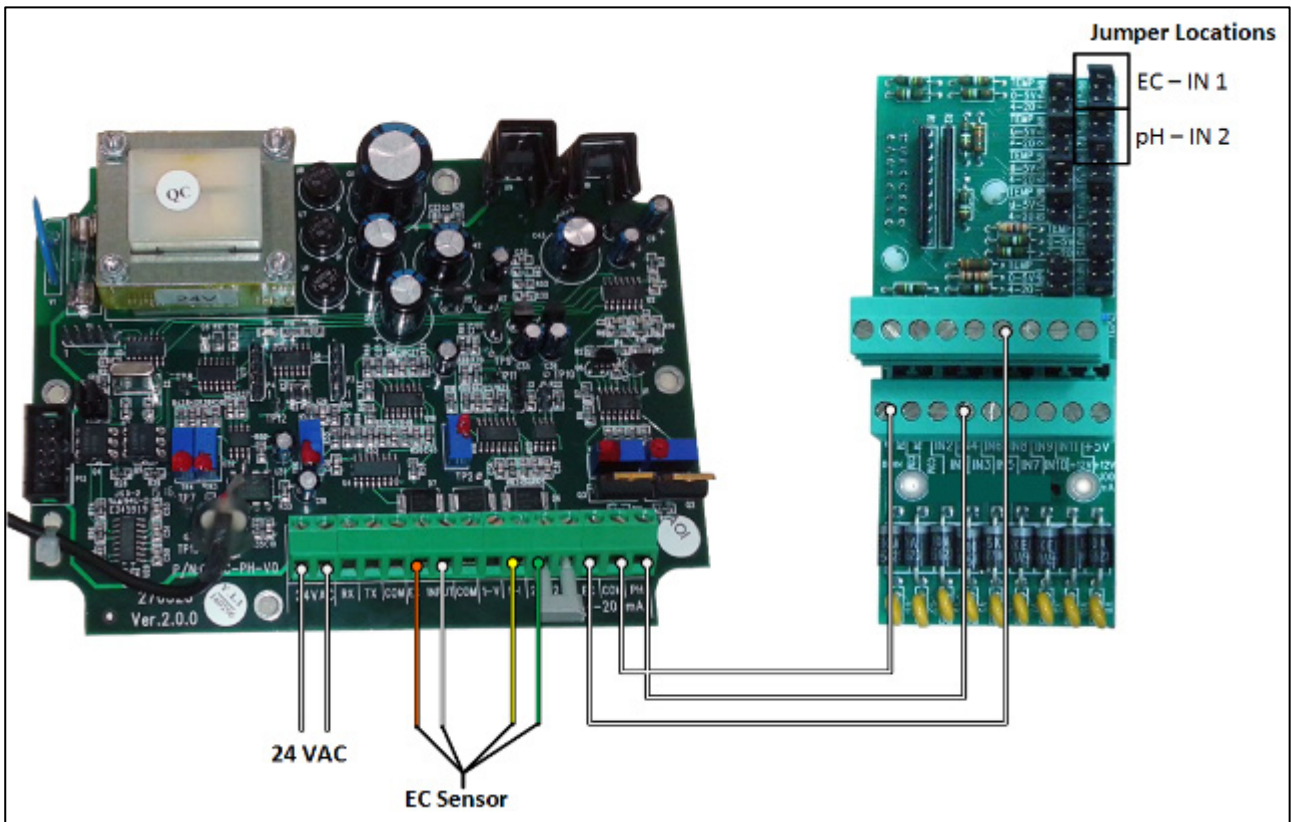

## 4.4 Expansion Unit Connection: Card Connection Options

- RS-485 Connection, page 38
- Wrong Relay Connection, page 40
- Expansion Unit, page 40
- PC and Inter-Controller Communication, page 41

### 4.4.1 RS-485 CONNECTION

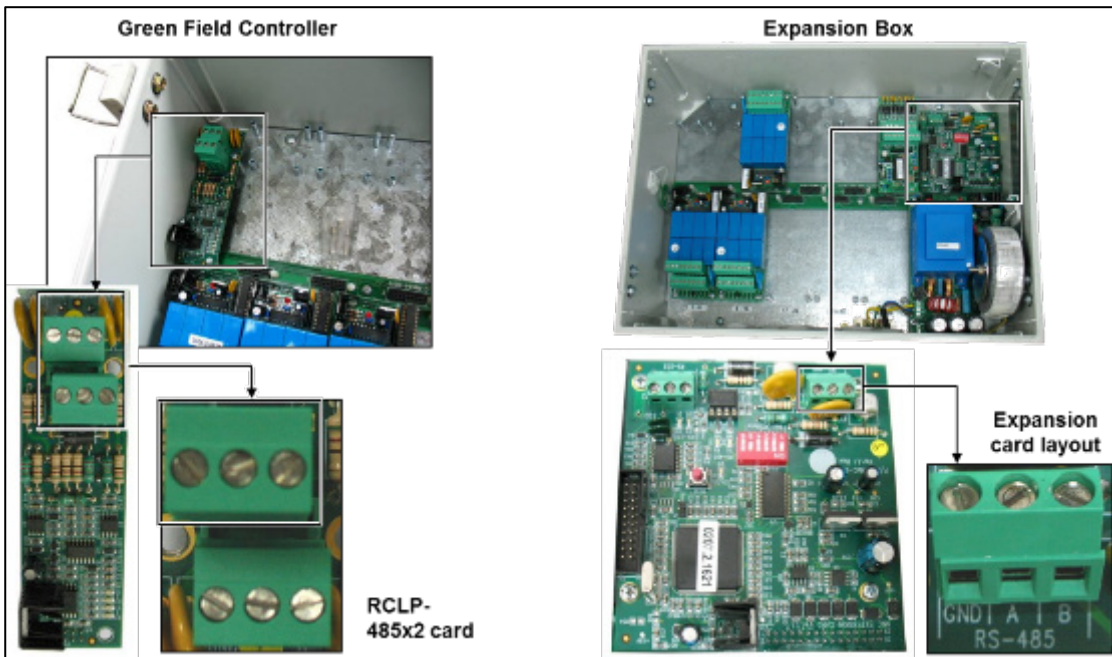

*NOTE* If there are more than 64 outputs, use an extension box.

*NOTE* Distance from controller: See table on next page.

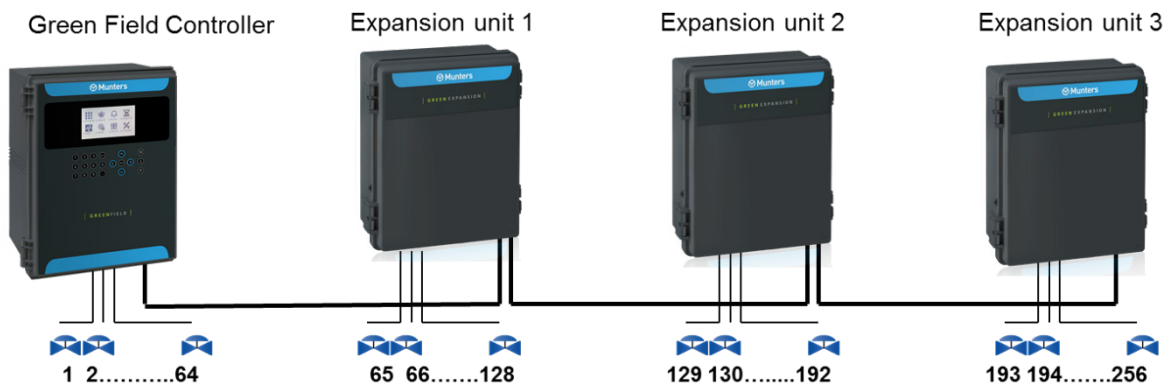

*NOTE* The maximum number of outputs is 256 but the maximum number of valves is 255.

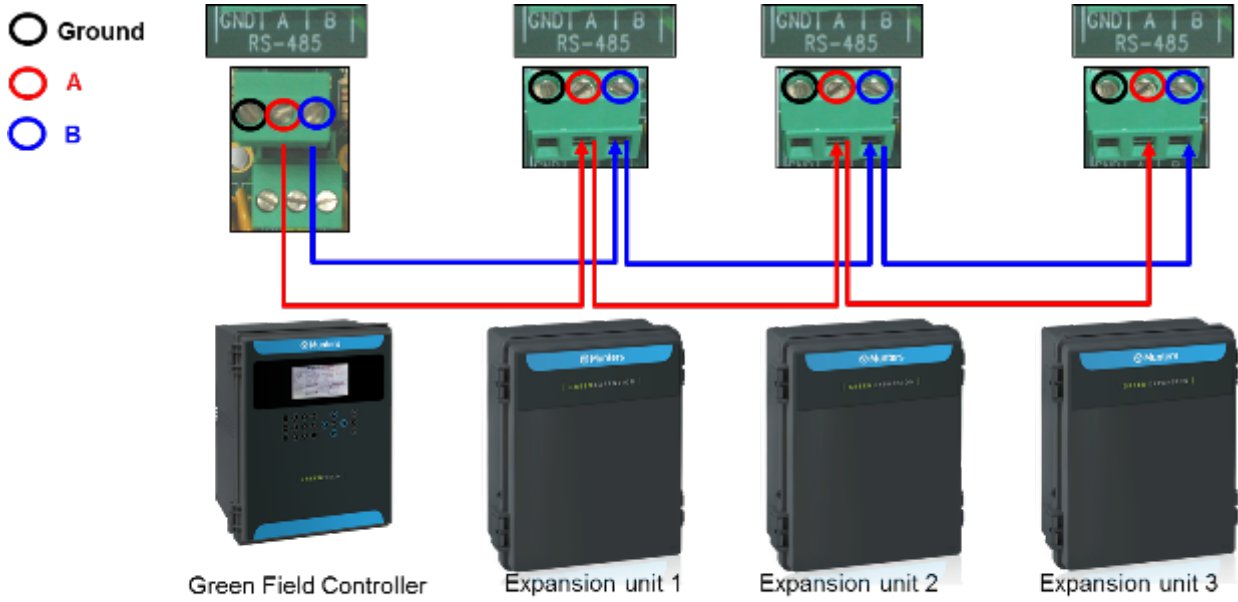

Distance from controller: See table on next page.

**NOTE** See the following table for details on permitted distances from the controller.

**Table 1: Permitted Distance from Controller RS-485**

One Expansion Box	<b>Distance</b>	<b>Baud Rate</b>
	2000 m	9600
	2500 m	4800
	3000 m	2400
Three Expansion Boxes	<b>Distance</b>	<b>Baud Rate</b>
	1200 m	9600
	1800 m	4800
	3000 m	2400

## 4.4.2 WRONG RELAY CONNECTION

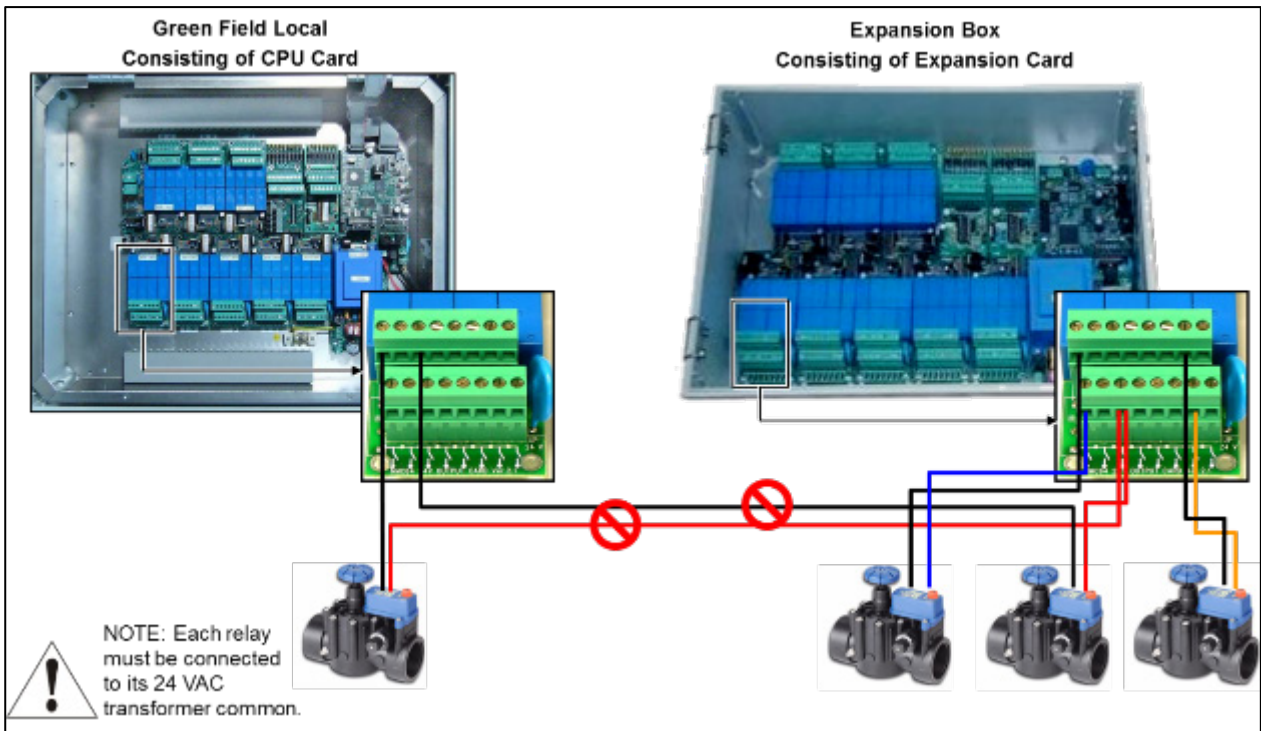

## 4.4.3 EXPANSION UNIT

- Expansion Unit Settings, page 40
- System Setup, page 41

### 4.4.3.1 Expansion Unit Settings

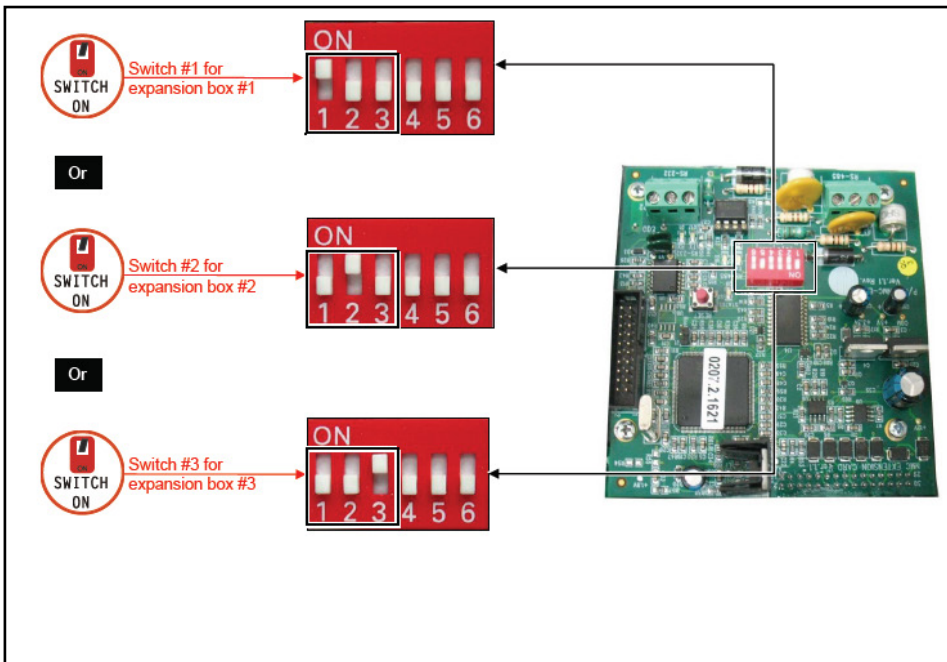

### 4.4.3.2 System Setup

**SWITCH ON**  
Main power

**SELECT**  
→ "6. Setup"  
→ "2. System setup"

**PERFORM**  
Set connected expansion boxes to "YES"

**SELECT**  
Baud rate according to cable length and number of controllers

**1** Program Manual Alarm History  
Test Setup Config Installation

**2** SETUP  
1. TIME & DATE  
2. SYSTEM SETUP  
3. TEMPERATURE CALIBRATION  
4. HUMIDITY CALIBRATION  
5. EC/PH CALIBRATION  
6. PRESSURE CALIBRATION  
7. WEATHER STATION CALIBRATION  
8. SENSOR LOGGING  
9. WRITE TO DATA PLUG  
10. READ FROM DATA PLUG

**3** SYSTEM SETUP  
Default Hotkey Number: 1  
History Resolution: 1 HOUR  
Weather Station: MASTER  
Controller Function: CONTROLLER  
Controller Number: 1  
BaudRate - Lower Port: 9600  
BaudRate - Upper Port: 9600  
Remote Unit Type: NONE  
Expansion Box 1 Connected?: YES  
Expansion Box 2 Connected?: NO  
Expansion Box 3 Connected?: NO

**4** SYSTEM SETUP  
Default Hotkey Number: 1  
History Resolution: 1 HOUR  
Weather Station: MASTER  
Controller Function: CONTROLLER  
Controller Number: 1  
BaudRate - Lower Port: 2400  
BaudRate - Upper Port: 9600  
Remote Unit Type: NONE  
Expansion Box 1 Connected?: YES  
Expansion Box 2 Connected?: NO  
Expansion Box 3 Connected?: NO

SYSTEM SETUP  
Default Hotkey Number: 1  
History Resolution: 1 HOUR  
Weather Station: MASTER  
Controller Function: CONTROLLER  
Controller Number: 1  
BaudRate - Lower Port: 9600  
BaudRate - Upper Port: 9600  
Remote Unit Type: NONE  
Expansion Box 1 Connected?: YES  
Expansion Box 2 Connected?: YES  
Expansion Box 3 Connected?: NO

### 4.4.4 PC AND INTER-CONTROLLER COMMUNICATION

- Card Installation
- Comm-Box Wiring

#### 4.4.4.1 Card Installation



Insert RS-485/485x 2 card

**Option A: R485**

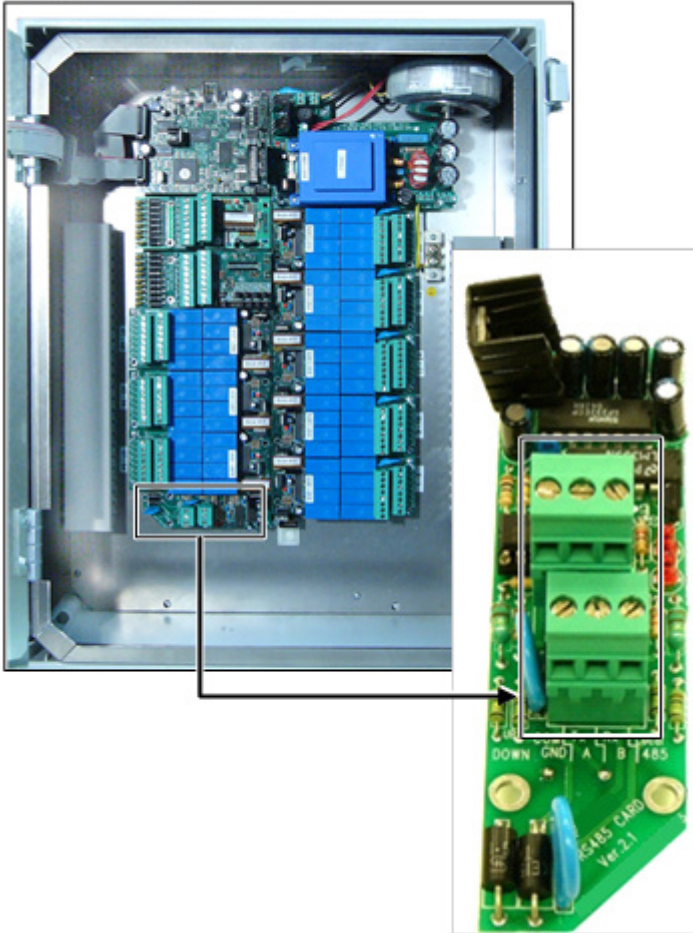



### 4.4.4.2 Comm-Box Wiring

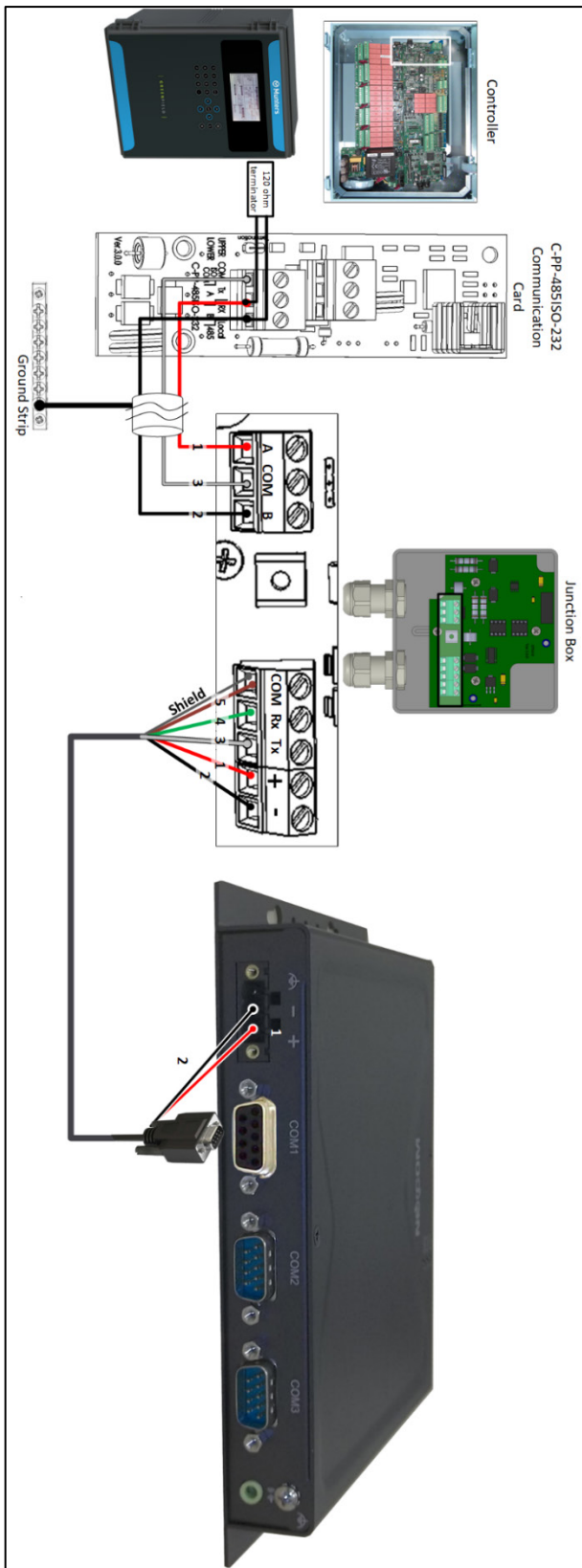

The wiring is detailed in following table:

Number	Color Wire
1	Red
2	Black
3	White
4	Green
5	Brown
COM Port	Shield wire

Figure 1: RS-485 Wiring to Comm-Box

**NOTE** Refer to the Comm-Box Manual for wiring details, how to log-on to the Comm-Box and manage the controller.

### 4.4.4.3 CommBox Plus Wiring

In the controller, connect the CommBox Plus to the controller's communication card, via the Junction Box. Refer to the following illustrations.

**NOTE** GreenField irrigation installation supports RS-485 wiring only.

1. The cable between the controller and the Junction Box should be a 3-wire twisted shielded cable (22 or 24 AWG).
2. Connect the wiring as follows:
  - COM to COM
  - CommBox Plus A port is connected to Controller's A port.
  - The CommBox Plus B port is connected to Controller's B port.
3. The final controller in any chain or branch requires a 120-ohm terminator.
4. Connect the cable shield wire to the controller ground strip.

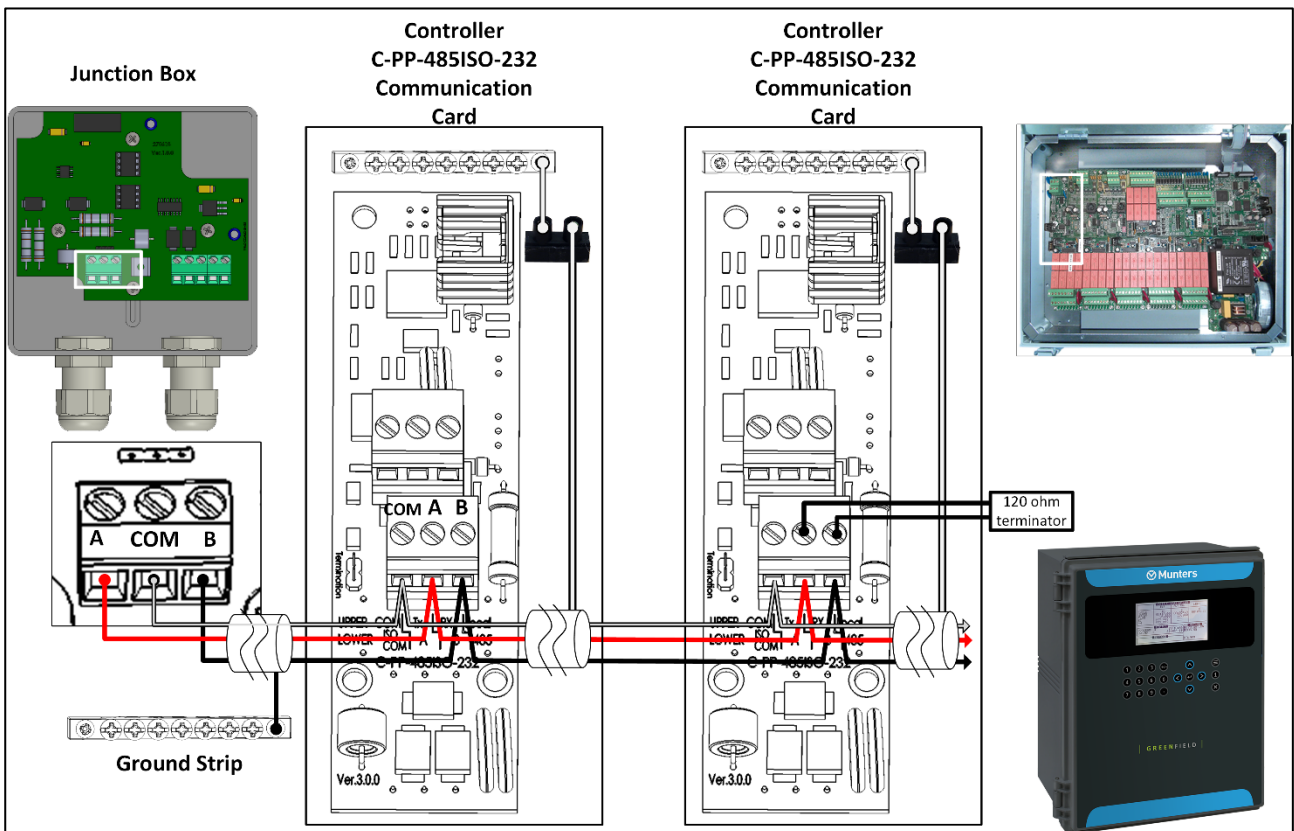

Figure 2: Green Field RS-485 Wiring

**CAUTION** Connect one end of the cable's shield only (the other end must be open). Each controller should be chain connected to the same wire, resulting in a long ground cable without a ground loop.

### 4.4.4.4 Communication Distance and Baud Rate

Baud Rate	One Controller	10 Controllers
9600 BPS	2000 meter 1.25 mile	1200 meter 0.75 mile
4800 BPS	2500 meter	1800 meter

	1.55 mile	1.12 mile
2400 BPS	3000 meter 1.86 mile	2400 meter 1.49 mile

NOTE Baud rate is dependent on cable length and number of controllers.

## 4.5 Controller Setup

- Start-Up, page 45
- Hardware Checklist, page 45
- Output Definition, page 46
- Digital Input Definition, page 46
- Analog Input Definition, page 47

### 4.5.1 START-UP

The diagram illustrates the start-up procedure. On the left, a menu structure is shown with icons for 'RUN PROGRAM' (Irrigation system and controller set-up and definition), 'SWITCH ON' (System), 'PRESS' (System), and a menu icon. A red arrow labeled '1' points to a physical 'SO MAIN' switch being turned on. Another red arrow labeled '2' points to a touch-screen menu with options: Program, Manual, Alarm, History, Test, Setup, Config, and Installation. A blue arrow points to the 'Installation' option.

### 4.5.2 HARDWARE CHECKLIST

The diagram shows the hardware checklist procedure. A red arrow labeled '3' points to the 'INSTALLATION' menu where '6. HARDWARE CHECKLIST' is selected. A red arrow labeled '4' points to the 'HARDWARE CHECKLIST' screen. Below the screen, a table shows the checklist details with callouts to physical components.

HARDWARE CHECKLIST	
DESCRIPTION	FOUND
Analog Input	1
Digital Input	1
Analog Output	0
Relay Card	2

COM.	---	---	---	A. In No.1	D. In No.1
Relay 1→8	Relay 9→16	---	---	---	P. .

Callouts from the table point to: 1<sup>st</sup> relay card, 2<sup>nd</sup> relay card, Analog Input 1, and Digital Input 1.

Additional icons on the left include 'SELECT' (7. Hardware Check list\* in Installation menu) and 'CHECK' (For Reference Only- overview of hardware check inputs and outputs).



## 4.5.5 ANALOG INPUT DEFINITION



\*5. Analog Input 1\* in Installation menu



Channel 1 and enter additional sensors according to terminal



Previous step for all other analog input sensors

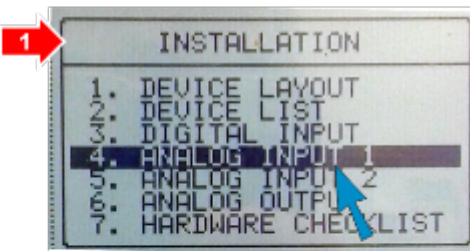

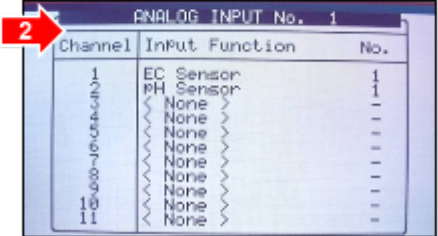

**NOTE** For sensor installation and definition, please refer to Appendix D.

## 4.5.6 ANALOG OUTPUT DEFINITION

1. In the Installation menu, select Device Layout.



2. In the screen that appears, define the required number of channels as Dosing channels.



Relay	Function	Channel No.
LOCAL	Dosing	06. Dosing Channel
LOCAL	Dosing	07. Dosing Booster
LOCAL	Dosing	08. Selector
LOCAL	Dosing	09. Agitator
LOCAL	Dosing	10. Cooling
LOCAL	Dosing	11. Mistings
LOCAL	Dosing	12. Water Heater
LOCAL	Dosing	13. Alarm
LOCAL	Dosing	14. Cond. Active #
LOCAL	Dosing	15. EC P-Ctrl Open
LOCAL	None	16. EC P-Ctrl Close
LOCAL	None	17. EC P-Ctrl Pump

**NOTE** The possible number of Dosing Channel depends on the number of installed analog output cards.

3. In the Installation menu, select Analog Output.



4. In the screen that appears, map analog outputs to dosing channels

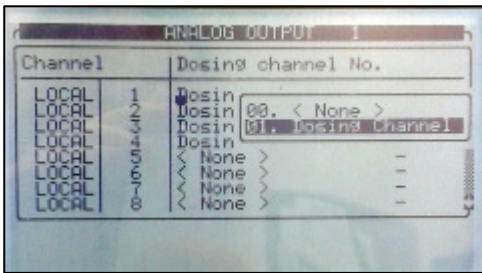

## 4.6 Controller Test Procedure

- Test Relays, page 48
- Digital Input Test, page 49
- Analog Input Test, page 49

### 4.6.1 TEST RELAYS

**1** Test

**2** TEST

**3** TEST RELAYS

**4** TEST RELAYS

⇒ "1. Relays" to test output devices in the field (dry test)  
 ⇒ Highlight status, press ENTER, "MAN" appears  
 ⇒ To end process press ENTER again

For Irrigation valve test, send someone out in field with Walky-Talky to verify status

Output Level(A/D): ≤300 A/D when all outputs are on.  
 If output level is above 300, see Troubleshooting Appendix B

OUTPUT#	FUNCTION	STATUS
1	Dosing Channel 1	OFF
2	Dosing Channel 2	OFF
3	Dosing Channel 3	OFF
4	Dosing Channel 4	OFF
5	Dosing Channel 5	OFF
6	Dosing Booster 1	OFF
7	None	OFF
8	None	OFF

OUTPUT#	FUNCTION	STATUS
1	Dosing Channel 1	MAN
2	Dosing Channel 2	OFF
3	Dosing Channel 3	OFF
4	Dosing Channel 4	OFF
5	Dosing Channel 5	OFF
6	Dosing Booster 1	OFF
7	None	OFF
8	None	OFF

## 4.6.2 DIGITAL INPUT TEST

**1** **TEST**

1. RELAYS  
**2. DIGITAL INPUT**  
 3. ANALOG INPUT  
 4. TEMPERATURE  
 5. HUMIDITY  
 6. ANALOG SENSOR  
 7. HARDWARE CHECKLIST  
 8. ANALOG OUTPUT

**2** **DIGITAL INPUT**

Channel	Card No.1	Card No.2
00-1000-0000-0000	25	00000000

**PERFORM** Dry test- Get a pulse using magnet; attach magnet to get a pulse from the "read" of the cable

**3** 

**VERIFY**

⇒ Water, fertilizer and any auxiliary meters: Count up 1-256  
 ⇒ Delta pressure and other dry contact inputs: 1= ON, 0= OFF

## 4.6.3 ANALOG INPUT TEST

**1** **TEST**

1. RELAYS  
 2. DIGITAL INPUT  
**3. ANALOG INPUT**  
 4. TEMPERATURE  
 5. HUMIDITY  
 6. ANALOG SENSOR  
 7. HARDWARE CHECKLIST  
 8. ANALOG OUTPUT

**2** **ANALOG INPUT**

Channel	Card No.1	Card No.2
00-1000-0000-0000	207	---
00-1000-0000-0000	473	---
00-1000-0000-0000	1022	---
00-1000-0000-0000	1022	---
00-1000-0000-0000	1022	---
00-1000-0000-0000	1023	---
00-1000-0000-0000	0	---
00-1000-0000-0000	1	---
00-1000-0000-0000	0	---
00-1000-0000-0000	1009	---

**3** **TEMPERATURE**

No.	Value
1	23.8
---	---
---	---
---	---
---	---
---	---

**4** **HUMIDITY**

No.	Value
1	58.1
---	---
---	---
---	---
---	---
---	---

**4. Temperature** or **5. Humidity**- values will be displayed

Channel	Card No.1	Card No.2
00-1000-0000-0000	205	---
00-1000-0000-0000	615	---
00-1000-0000-0000	1023	---
00-1000-0000-0000	205	---

Description	Sensor Type
pH = 0 - A/D = 205	pH sensor
pH = 7.0 - A/D = 615	
pH = 14.0 - A/D = 1023	
EC = 0 - A/D = 205	EC sensor

Description	Sensor Type
EC = 2.0 - A/D = 370	Humidity sensor
EC = 10.0 - A/D = 1024	
RH% = 0 - A/D = 0	
RH% = 50 - A/D = 308	
RH% = 100 - A/D = 620	
T°C = 0 - A/D = 768	Temp sensor
T°C = 25 - A/D = 489	
T°C = 50 - A/D = 250	

#### 4.6.4 ANALOG OUTPUT TEST

The Analog Output Test screen performs two functions:

- Automatic test: Displays the current state of the valves (functioning or not functioning)
- Manual test: Tests their response to a test signal

*NOTE If there is a non-functioning (analog-output controlled) valve, a message appears on the main screen.*

- Automatic Test
- Manual Test

##### 4.6.4.1 Automatic Test

Automatic testing shows the current state of the valves.

1. Go to Test > Analog Output.

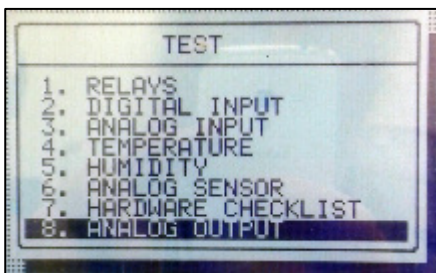

2. The screen displays the following:

A screenshot of the 'ANALOG OUTPUT' screen. It displays a table with the following data:

N#	Status	Open%	Meas	Fail
1	AUTO	----	54.56	ON
2	AUTO	----	54.56	ON
3	AUTO	----	54.56	ON
4	AUTO	----	54.56	ON
5	AUTO	----		OFF
6	AUTO	----		OFF
7	AUTO	----		OFF
8	AUTO	----		OFF

- When the test is set to Auto, the screen displays the status of active dosing valves.
  - Active valves display a voltage under Meas.
  - If the status (under Fail) is ON, the valve is closed.
  - In the screen above, valves 1 – 4 are active, but they are closed.



## 4.6.4.2 Manual Test

Manual testing enable you to verify that valves open in response to an electrical current.

1. Go to Test > Analog Output.

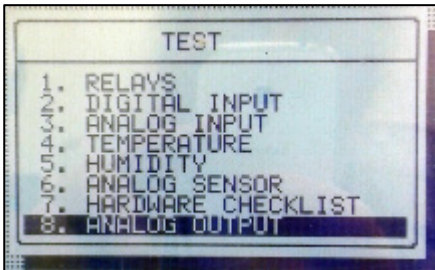

2. The screen displays the following:

N#	Status	Open%	Meas	Fail
1	AUTO	----	54.56	ON
2	AUTO	----	54.56	ON
3	AUTO	----	54.56	ON
4	AUTO	----	54.56	ON
5	AUTO	----		OFF
6	AUTO	----		OFF
7	AUTO	----		OFF
8	AUTO	----		OFF

3. Place the cursor on the valve requiring testing, press Enter and select.

N#	Status	Open%	Meas	Fail
1	AUTO	----	54.56	ON
2	AUTO	----	54.56	ON
3	AUTO	----	54.56	ON
4	AUTO	----	54.56	ON
5	AUTO	----		OFF
6	AUTO	----		OFF
7	AUTO	----		OFF
8	AUTO	----		OFF

4. Under Open%, enter an opening percentage.

N#	Status	Open%	Meas	Fail
1	MAN	33-	54.56	ON
2	AUTO	----	54.56	ON
3	AUTO	----	54.56	ON
4	AUTO	----	54.56	ON
5	AUTO	----		OFF
6	AUTO	----		OFF
7	AUTO	----		OFF
8	AUTO	----		OFF

- GreenField sends an electrical current to the valve, based on the number entered.
- If the valve opens, OFF appears under Fail. If the valve does not open, ON appears.

## 4.7 System Configuration Procedure

- Device Delay Configuration, page 52
- Pump Station Configuration, page 53
- Valve Configuration, page 53
- Valve Flow Rate Configuration, page 54

- Water Meter Configuration, page 54
- Dosing Configuration, page 56
- EC/PH Sensor Range, page 56
- History Resolution, page 57
- System Nutrigation™ Check, page 57
- Data Plug, page 59

#### 4.7.1 DEVICE DELAY CONFIGURATION

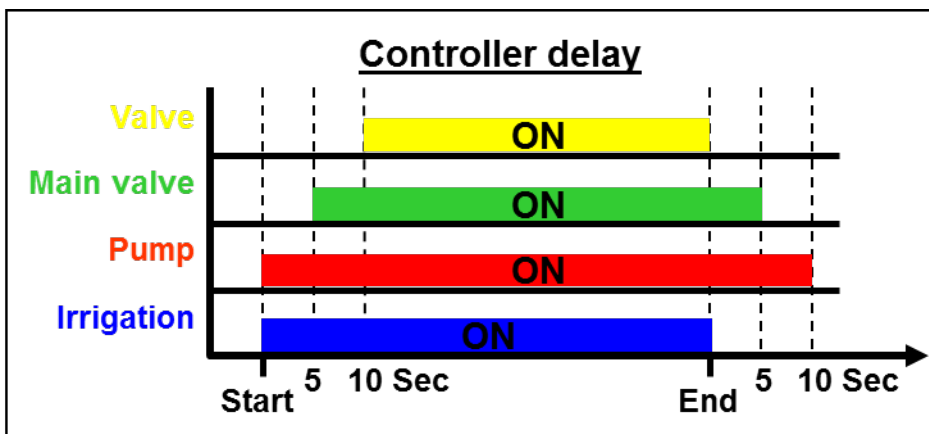
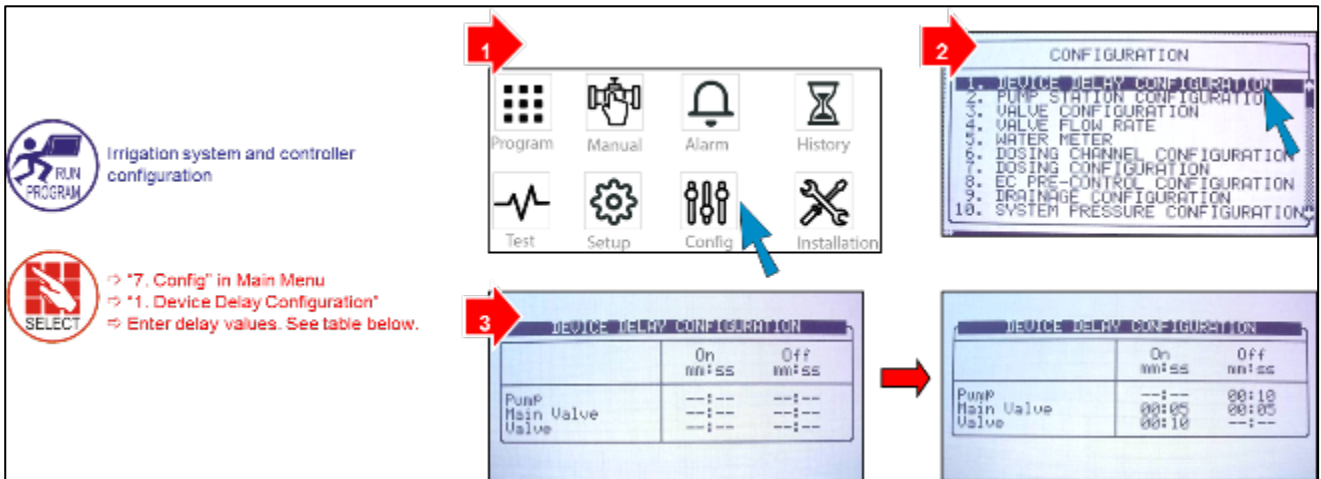

NOTE Settings in the graph are for example only.

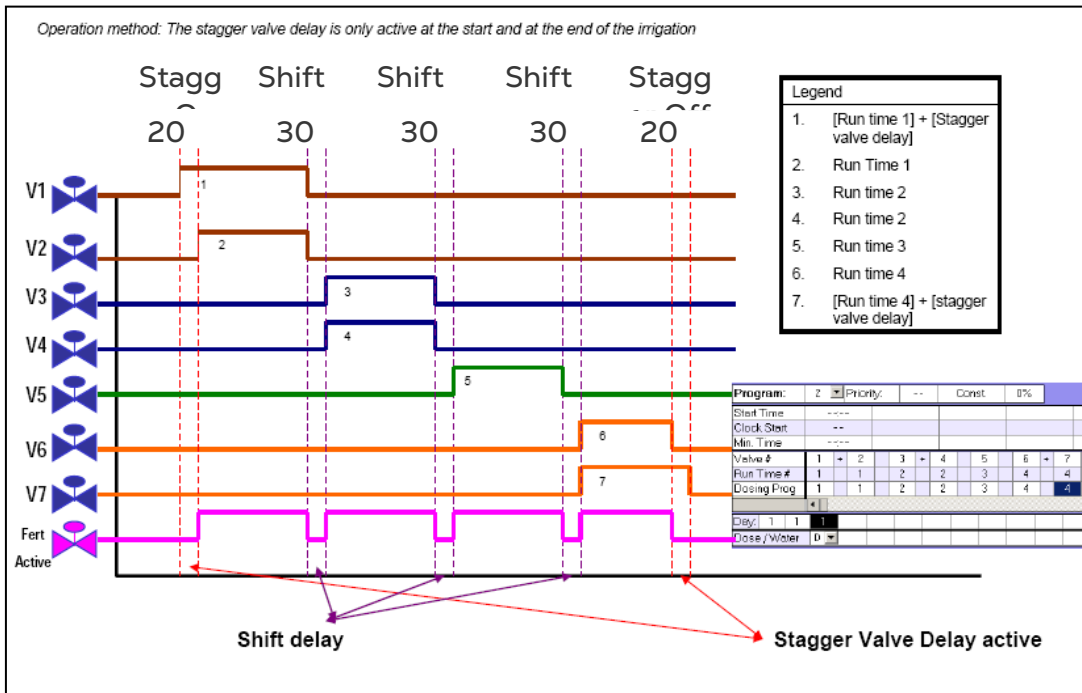

NOTE During shift and stagger delays, the Fertilization is not active

#### 4.7.2 PUMP STATION CONFIGURATION

SELECT → "2. Pump Station Configuration"  
 → Define capacity of main pump (USA: Gallon/min.)

1. DEVICE DELAY CONFIGURATION  
 2. PUMP STATION CONFIGURATION  
 3. VALVE CONFIGURATION  
 4. VALVE FLOW RATE  
 5. WATER METER  
 6. DOSING CHANNEL CONFIGURATION  
 7. DOSING CONFIGURATION  
 8. EC PRE-CONTROL CONFIGURATION  
 9. DRAINAGE CONFIGURATION  
 10. SYSTEM PRESSURE CONFIGURATION

PUMP STATION CONFIGURATION

Pump No.	Capacity m3/h	Stability mm:ss	Off Delay mm:ss
1	100,000	--:--	--:--

NOTE If there is more than one pump, refer to GreenField Advanced Settings.

#### 4.7.3 VALVE CONFIGURATION

SELECT → "3. Valve Configuration"  
 → Allocate pump, main valve and water meter  
 (Note: If there is more than 1 pump, refer to Green Field User Manual)

1. DEVICE DELAY CONFIGURATION  
 2. PUMP STATION CONFIGURATION  
 3. VALVE CONFIGURATION  
 4. VALVE FLOW RATE  
 5. WATER METER  
 6. DOSING CHANNEL CONFIGURATION  
 7. DOSING CONFIGURATION  
 8. EC PRE-CONTROL CONFIGURATION  
 9. DRAINAGE CONFIGURATION  
 10. SYSTEM PRESSURE CONFIGURATION

VALVE CONFIGURATION

Valve No.	Pump	Main Valve	Water Meter	Drain Meter
1	Pump 1	1	1	--
2	Pump 1	1	1	--
3	Pump 1	1	1	--

## 4.7.4 VALVE FLOW RATE CONFIGURATION

**SELECT**

⇒ "4. Valve Flow Rate" (USA: Gallon/min.)  
 ⇒ Define exact flow consumption of every valve:  
 Technician must calculate formula:  
 $[\text{Drippers/lateral} \times \text{dripper capacity (liters/hr)} \times \# \text{ of laterals/valve}] \div 1000 = \text{nominal flow of valve (m}^3\text{/hr)}$   
 ⇒ Set Min./Max. flow rate limits per valve for alarm  
 (already defined as 25% by default)

**3**

Valve No.	Nominal m <sup>3</sup> /h	Minimum m <sup>3</sup> /h	Maximum m <sup>3</sup> /h
1	80.000	60.000	100.000
2	90.000	67.500	112.500
3	85.000	63.750	106.250
4	100.000	75.000	125.000

**!**

NOTE: In case of use of multiple water meters or drain meter, please refer to *Advanced Settings*

## 4.7.5 WATER METER CONFIGURATION

**SELECT**

⇒ "5. Water Meter"  
 ⇒ Define resolution of water meter-  
 See label on water meter as shown in Step 2 (USA: Gallon/min.)

**CHECK**

If there is no label, check data sheet supplied with the meter.

**1**

CONFIGURATION		
1.	DEVICE DELAY CONFIGURATION	
2.	PUMP STATION CONFIGURATION	
3.	VALVE CONFIGURATION	
4.	VALVE FLOW RATE	
5.	WATER METER	
6.	DOSING CHANNEL CONFIGURATION	
7.	DOSING CONFIGURATION	
8.	EC PRE-CONTROL CONFIGURATION	
9.	DRAINAGE CONFIGURATION	
10.	SYSTEM PRESSURE CONFIGURATION	

**2**

**3**

Description	Ratio	Type
Water Meter 1(L/P)	10.000	STANDARD
Water Meter 2(L/P)	---	STANDARD
Water Meter 3(L/P)	---	STANDARD
Water Meter 4(L/P)	---	STANDARD
Water Meter 5(L/P)	---	STANDARD
Water Meter 6(L/P)	---	STANDARD
AUX Meter 1(L/P)	---	---
AUX Meter 2(L/P)	---	---
AUX Meter 3(L/P)	---	---
AUX Meter 4(L/P)	---	---
AUX Meter 5(L/P)	---	---

NOTE If there is more than one water meter, refer to *GreenField Advanced Settings*.

DOSING CONFIGURATION	
pH Control	YES
EC Alarms	YES
pH Alarms	YES
Minimum On Time (sec)	1.0
Minimum Off Time (sec)	1.0
EC Coarse Tuning (0-10)	1
EC Fine Tuning (0-10)	3
pH Coarse Tuning (0-10)	4
pH Fine Tuning (0-10)	4
Control Cycle EC (sec)	4
Control Cycle pH (sec)	4
EC/pH Averaging(0-Low, 20-High)	4

## 4.7.6 DOSING CHANNEL CONFIGURATION

**1** CONFIGURATION

1. DEVICE DELAY CONFIGURATION  
2. PUMP STATION CONFIGURATION  
3. VALVE CONFIGURATION  
4. VALVE FLOW RATE  
5. WATER METER  
6. **DOSING CHANNEL CONFIGURATION**  
7. DOSING CONFIGURATION  
8. EC PRE-CONTROL CONFIGURATION  
9. DRAINAGE CONFIGURATION  
10. SYSTEM PRESSURE CONFIGURATION

**2**

No.	Pump	Method	Ratio
1	Analog	Time(Lit/h)	300.000
2	Analog	Time(Lit/h)	300.000
3	Analog	Time(Lit/h)	300.000
4	Analog	Time(Lit/h)	300.000

**3**

No.	React	High(%)	Low(%)
1	EC	50	50
2	EC	50	50
3	EC	50	50
4	PASSIVE	---	---

**4**

No.	React	High(%)	Low(%)
1	EC	50	50
2	EC	50	50
3	EC	50	50
4	PASSIVE	---	---

**5. Dosing channel Configuration\***  
 ⇨ Define flow rate of every Venturi (USA: Gallon/hr.)  
 ⇨ Define channels 1-4=EC  
 ⇨ Define channel 5=Acid

## 4.7.7 ANALOG DOSING CHANNEL CONFIGURATION

1. Go to Configuration > Dosing Channel Configuration.

No.	Pump	Method	Ratio
1	Analog	Time(Lit/h)	300.000
2	Analog	Time(Lit/h)	300.000
3	Analog	Time(Lit/h)	300.000
4	Analog	Time(Lit/h)	300.000

Dosing Channel Config. - 1								
No.	Pump	Method	Ratio	React	High	Low	V/P (L)	
1	Analog	Time (Liter/Hour)	300.000	EC	50	50	-----	
2	Analog	Time (Liter/Hour)	300.000	EC	50	50	-----	
3	Analog	Time (Liter/Hour)	300.000	ACID	50	50	-----	
4	Analog	Time (Liter/Hour)	300.000	PASSIVE	---	---	-----	

2. Define the Pump type as Analog.
  - Leave the Ratio at the default definition (refer to Calibrating the Analog Dosing Valves, page 127).
3. Go to Configuration > Dosing Configuration.
4. Munters recommends setting the parameters as shown below. However, you can change these specifics if needed.

**NOTE** In case that different dosing pump (electric) or setting (fertilizer meter), refer to GreenField Advanced Settings.

**NOTE** For a more detailed description of this procedure, refer to Section 11.6, Dosing Channel Configuration page, 126.

## 4.7.8 DOSING CONFIGURATION



- ⇒ "7. Dosing Configuration"
- ⇒ EC and PH Control and Alarms to "Yes", only when using EC and pH control
- ⇒ Set Min. On Time of each dosing channel according to the operated device. For example:
  - At NetaJet High Flow it should be 1 sec
  - At NetaJet Inline/Bypass it should be 0.8 sec
- ⇒ Set Min. Off Time of each dosing channel according to the operated device. For example:
  - At NetaJet High Flow it should be 1 sec
  - At NetaJet Inline/Bypass it should be 0.8 sec
- ⇒ To set Control Cycle, run system and measure time in seconds it takes to see reaction of EC/pH meter
- ⇒ Set dosing Booster Delay to 10 seconds (Time booster continues running after dosing process)

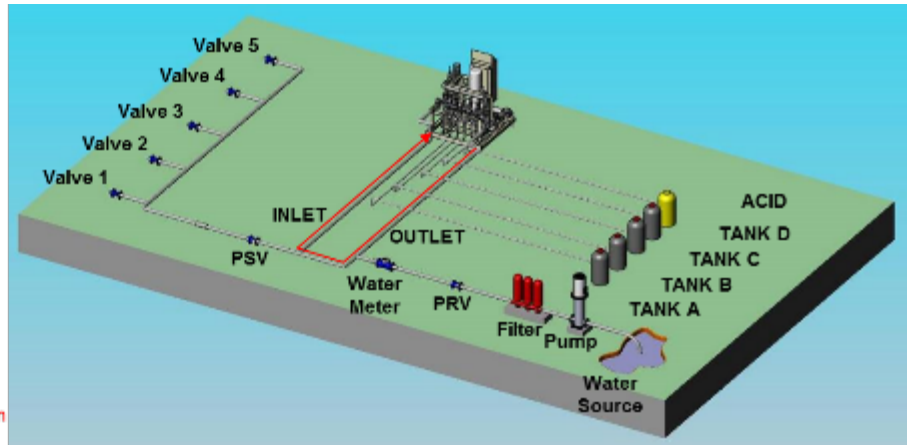

CONFIGURATION		DOSING CONFIGURATION	
1. DEVICE DELAY CONFIGURATION		EC Control	YES
2. PUMP STATION CONFIGURATION		pH Control	YES
3. VALVE CONFIGURATION		EC Alarms	YES
4. VALVE FLOW RATE		pH Alarms	YES
5. WATER METER		Minimum On Time (sec)	0.8
<b>6. DOSING CHANNEL CONFIGURATION</b>		Minimum Off Time (sec)	0.8
7. DOSING CONFIGURATION		EC Coarse Tuning	5
8. EC PRE-CONTROL CONFIGURATION		EC Fine Tuning	5
9. DRAINAGE CONFIGURATION		pH Coarse Tuning	5
10. SYSTEM PRESSURE CONFIGURATION		pH Fine Tuning	5
		Control Cycle EC	4
		Control Cycle pH	4
		EC/pH Averaging (0-Low, 20-High)	3
		Dosing Boost Off Delay (mm:ss)	00:02
		Dosing by QTY. Method	SPREAD

NOTE For different dosing settings, refer to GreenField Advanced Settings.

## 4.7.9 EC/PH SENSOR RANGE



- ⇒ "12. EC/pH Configuration"
- ⇒ Leave as is unless using non standard EC/pH sensors

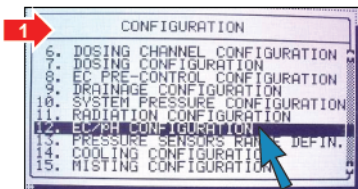

EC/PH CONFIGURATION			
Sensor	4 mA	20 mA	Sensor Dif.
EC 1	0	10	
EC 2	0	14	
EC 3	0	10	----
EC 4	0	14	----
EC 5	0	20	
EC Control Sensor	▶		EC 1+EC 2
pH Control Sensor	▶		pH 1+pH 2

NOTE When using multiple EC or pH sensors, refer to GreenField Advanced Settings.

## 4.7.10 HISTORY RESOLUTION



Program how often computer should collect sensor data. (Keep in mind that lower resolution will quickly fill the memory and overwrite the old data - See Green Field User Manual)



**NOTE** For more details on system setup, refer to GreenField Advanced Settings.

## 4.7.11 SYSTEM NUTRIGATION™ CHECK

- EC/pH IS ON Target
- System Nutrigation Simulation
- Water Run Time
- Start/Stop Valve

### 4.7.11.1 EC/pH IS ON Target

1

2

3

Enter desired amount of fertilizer to inject per dosing channel in l/m<sup>3</sup> (USA: Gallon/1000 gallon)

4

Enter desired target EC/pH levels

**ENSURE**

Know limits of irrigation system. Calculate max. allowed injection:  
 (Dosing channel suction flow + average flow rate from field) X 0.8 =  
 Max. injection quantity (l/m<sup>3</sup>, USA: Gallon/1000 gallon.)

### 4.7.11.2 System Nutrigation Simulation

**PERFORM**

- ⇒ 10 liters of water in bucket
- ⇒ Inject 50 ml of fertilizer from each tank
- ⇒ Inject 30 ml of acid
- ⇒ Mix until acid and fertilizer is dissolved

**CHECK**

- ⇒ EC and pH levels.
- ⇒ Results should be relatively close to desired target.
- ⇒ Deviation of  $\leq 0.5$  from target is allowed.

**ATTENTION**

Use protective equipment, gloves and goggles when handling fertilizers, acid and other chemicals!

### 4.7.11.3 Water Run Time

**1**

**SELECT**

**2**

**3**

#	Method	Water	Before	After
1	TIME	00:10:00	00:00:00	00:00:00
2	OTV.	0.000	0.000	0.000
3	OTV.	0.000	0.000	0.000
4	OTV.	0.000	0.000	0.000
5	OTV.	0.000	0.000	0.000
6	OTV.	0.000	0.000	0.000
7	OTV.	0.000	0.000	0.000
8	OTV.	0.000	0.000	0.000
9	OTV.	0.000	0.000	0.000
10	OTV.	0.000	0.000	0.000
11	OTV.	0.000	0.000	0.000

Enter water run time or quantity

### 4.7.11.4 Start/Stop Valve

**1**

**SELECT**

**2**

**3**

#	Method	Water	Before	After
1	TIME	00:10:00	00:00:00	00:00:00
2	OTV.	0.000	0.000	0.000
3	OTV.	0.000	0.000	0.000
4	OTV.	0.000	0.000	0.000
5	OTV.	0.000	0.000	0.000
6	OTV.	0.000	0.000	0.000
7	OTV.	0.000	0.000	0.000
8	OTV.	0.000	0.000	0.000
9	OTV.	0.000	0.000	0.000
10	OTV.	0.000	0.000	0.000
11	OTV.	0.000	0.000	0.000

DOSING PROGRAM				
Program: 1				
1	2	3	4	5
EC	EC	EC	EC	ACID
5.00	5.00	5.00	5.00	3.00
Target EC				1.50
Target PH				P.OTV
EC Dosing Method				P.OTV
PH Dosing Method				P.OTV

Run Time Program (1)  
Dosing Program (1)



4

5

START/STOP VALVE

Do you really want to start valve 1?

YES NO

6

Active Irrigation Screen

	SET	ACTUAL	LEFT
CYCLE	1	1	0
WATER	00:10:00	00:00:10	00:09:51
FLOW	100.000	100.000	
EC	1.00	1.00	
PH	5.50	5.50	

7

	WATER	EC/pH
Status	irrig.	EL
Nom. Flow	100.000	Target 1.6 5.5
Act. Flow	100.000	Actual

	Open(%)	Min(%)	Pr9(%)	Max(%)
Chan. 1	OFF	70	100	100
Chan. 2	OFF	70	100	100
Chan. 3	OFF	70	100	100
Chan. 4	OFF	70	100	100

ENSURE

- ⇒ Difference between nominal and actual flow rate is ≤10%
- ⇒ Difference between target and actual EC/pH ≤0.2

## 4.7.12 DATA PLUG

1

INSERT

Data plug into terminal

2

Program Manual Alarm History

Setup Config Installation

SELECT

3

ENSURE

System is idle and not in process before "Write to Data Plug"

4

5

REMOVE

Data Plug from terminal at end of process

SETUP

1. TIME & DATE
2. SYSTEM SETUP
3. TEMPERATURE CALIBRATION
4. HUMIDITY CALIBRATION
5. EC/pH CALIBRATION
6. PRESSURE CALIBRATION
7. WEATHER STATION CALIBRATION
8. SENSOR LOGGING
9. WRITE TO DATA PLUG
10. READ FROM DATA PLUG

ACTION WILL OVERWRITE EXISTING DATA PLUG

ARE YOU SURE?

YES NO

# 5 Program Menu start here

In the Main Menu screen, place the cursor on the program icon and press ENTER, or press '1' to enter the Program Menu.



- Irrigation, page 61
- Using the Influences, page 65
- Setting the Influences, page 65
- Water Run Time, page 71
- Dosing, page 72
- Ext. Condition, page 74
- Agitator, page 76
- Selector, page 77
- Filter Flushing, page 77
- Cooling, page 78
- Misting, page 81
- Water Heating, page 82

*NOTE To enter any of the menus, press the corresponding numeric key or scroll to the desired item using the up/down arrow keys and press ENTER: a new window will appear. The first menu under Program is Irrigation.*

## 5.1 Irrigation

The Irrigation Program screen includes all the settings for configuring automatic irrigation start. It depends heavily on the Water Run Time and dosing program screens; therefore it is recommended to configure these screens before irrigation takes place.

The GreenField consists of 15 irrigation programs.

DATE : 20-Dec-06		TIME : 09:06:05	
IRRIGATION PROGRAM			
Program:	1	Priority:	--
Const.	50%		
Start Time	06:30	12:30	15:00
Clock Start	2	1	1
Min. Time	01:00	--:--	--:--
Valve #	051+052	004+116	115 255
Run Time #	1	1	2 2 2
Dosing Prog	1	1	3 3 4 4
Day: 04/06	1	2	3 4 5 6
Dose/Water	D	W	- D W D

- **Program:** Select a program by entering the program number and confirm by pressing **ENTER**.
- **Priority:** Priority determines the order in which programs will take place. If start time is the same, higher priority programs come first. Higher priority programs do not stop currently operative programs. If start time and priority are the same, irrigation programs with a lower number are executed first. Priority ranges are between 0 and 15, 15 being the highest (See GreenField Irrigation – Part 2 > Priority specifications for further information).
- **Const / Daily / Cond. / Rad Sum / VPD Sum:**
  - **CONST.:** Increase or decrease the amount of water for all valves included in this program. 0% means the quantities will be as specified in the Water Run Time program, 100% will be twice the amount and -50% will be half the amount specified in the Water Run Time Program. To decrease enter the required percentage of change, press the +/- key and confirm with the **ENTER** key. The percentage of change is active until you specify otherwise.
  - **DAILY:** Increase or decrease the amount of water for all valves included in this program. 0% means the quantities will be as specified in the Water Run Time program, 100% will be twice the amount and -50% will be half the amount specified in the Water Run Time Program. To decrease, enter the required percentage of change, press +/- key and confirm with the **ENTER** key. The percentage of change will be active only for the present day and will change automatically back to zero on End Day time.

**NOTE** *CONST. % and DAILY % does not change Quantity / time of water before and water after settings, nor dosing quantities.*

**NOTE** *When setting watering program and using 'Spread' the percentage affects not only the water but also the dosing.*

- **Cond.:** Specify whether the Condition program can trigger irrigations, and choose a Condition program to start/stop irrigations. Irrigations will be started and stopped according to the settings of the relevant Condition program (see Ext. Condition, page 74, for additional information). If irrigation

is not triggered due to Condition program until Max time has elapsed irrigation will be performed due to Max time.

When choosing Condition, the screen will be split in two. To view the day sequence, press the Down arrow when the cursor is placed on the bottom of the screen.

The Condition program has the third priority after active irrigation and uncompleted irrigation (See GreenField Irrigation – Part 2 > Priority specifications for further information).

DATE : 20-Dec-06 TIME : 09:07:30

IRRIGATION PROGRAM

Program:	3	Priority:	--	Cond.	1
Start Time	08:00				
Clock Start	1				
Con. Starts	ON				
Min. Time	00:10				
Max. Time	03:00				
Valve #	054 114				
Run Time #	2 2				
Dosing Prog	3 3				

reaching the bottom line...

DATE : 20-Dec-06 TIME : 09:07:43

IRRIGATION PROGRAM

Program:	3	Priority:	--	Cond.	1		
Day: 01/07	1	2	3	4	5	6	7
Dose/Water	D	-	-	-	D	-	-

Screen 2 of 2 - In order to view the

**NOTE** It is impossible to set the same Condition program for two different programs.

- Rad Sum / VPD Sum: Choose whether irrigations can be triggered by the radiation or VPD sum. The specific Rad Sum trigger is specified per period (see [Rad Sum Li.](#)). If irrigation is not triggered due to Rad/VPD Sum until Max time has elapsed irrigation will be performed due to Max time.

DATE : 20-Dec-06 TIME : 09:06:55

IRRIGATION PROGRAM

Program:	2	Priority:	--	Rad Sum	
Start Time	07:30	12:00	16:00		
Clock Start	1	--	--		
Rad Sum Li.	200	----	100		
Min. Time	01:00	00:30	--:--		
Max. Time	02:00	--:--	--:--		
Valve #	001	051+052	115	255	
Run Time #	1	2	2	2	--
Dosing Prog	1	2	2	3	2

Screen 1 of 2 - In order to view the

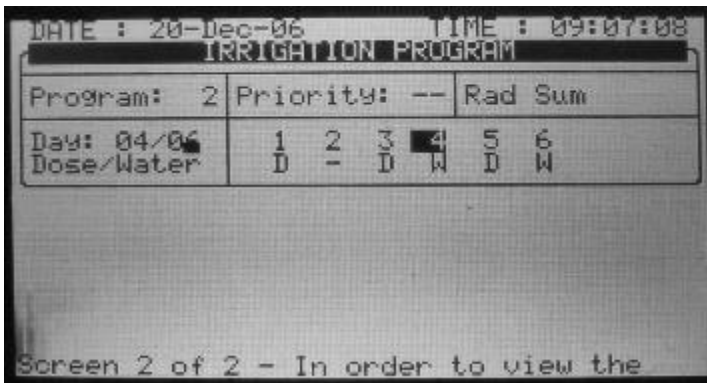

**NOTE** When choosing Rad/VPD Sum the screen will be split in two. To view the day sequence, press the Down arrow on the bottom part of the screen.

- **Start time (hh:mm):** ENTER up to six start times (periods) per day for each program.
- **Clock Start:** Set the number of time-based irrigation cycles that will be performed in this cycle. The first cycle starts at the specified start time; subsequent cycles will start after the specified Min. Time.
- **Cond. Starts** (appears only when Cond. Is selected): On/Off.
  - **On:** Irrigations can be triggered by the Condition program, when the specified Condition program settings are met (Condition program active).
  - **Off:** Irrigations will not be triggered by the condition program, regardless of the Condition program status.
- **Rad/VPD Sum Li.:** Specify the radiation/VPD sum limit at which irrigation will take place. The Rad/VPD Sum counter of the specific program is automatically reset when irrigation is performed. If Rad/VPD sum limit is '0' it is ignored.
- **Min. Time:**
  - In Rad/VPD sum and condition modes determine the minimum time allowed between irrigations.
  - Even if the Rad/VPD sum limit / condition limit has been reached irrigation will not be performed until that time has passed.
  - In clock starts the minimum time is the delay between start of a cycle until the start of the next cycle. For example if Clock Start is set to 2, the set Run Time is 30 minutes and the Min. Time is 45 minutes. The second cycle will start 15 minutes after the end of the first cycle.
- **Max. Time:** The maximum time between two subsequent cycles. This value is used to limit the time between two cycles when using dynamic irrigation triggers such as Rad/VPD Sum or the Condition program. When the specified Max. Time from the beginning of the previous cycle has elapsed; irrigation will take place regardless of the Rad/VPD Sum level or the Condition program status.
- **Valve #:** The GreenField can operate valves in any required order. Set the valve number and press enter. The following window will appear:



Select 'blank' and press ENTER to set the valve to operate alone, or '+' (plus) to operate together with the next valve. Several valves can be set to work together, as a group. A valve set (group) will have the same Run Time program and the same

dosing program. Each irrigation program can include a maximum of 100 valves (columns) in any required order (all of them together, one after the other, a few groups-max. 100 groups, etc.). The same valve can be entered several times with different settings.

- **Run Time #:** attach a Run Time Program to a valve or a group of valves. When setting valves to work individually, a Run Time Program should be set for each valve. When setting a few valves to work together (“+” mark between them) a Run Time Program should only be set for the first valve, the rest of the valves will follow this setting.

*NOTE The quantity set in the Run Time Program will be the quantity given for all valves set to operate together, not per valve (for further specifications of the Run Time Program see Water Run Time, page 65).*

- **Dosing Program:** Attach a Dosing Program to a valve or a group of valves. When setting valves to work individually, a Dosing Program should be set for each valve. When setting a few valves to work together (with “+” mark between them) a Dosing Program should only be set for the first valve, the rest of the valves will follow this setting.
- **Day (xx/xx):** Allows defining whether the program should irrigate water only, dose or be turned off on different days.

Dose
<input checked="" type="radio"/> Water
None

- (xx/xx): The right setting defines the day’s cycle.
- (xx/xx): The left setting defines the current day of the cycle.

Select Dose, Water or None and press ENTER. ‘Dose’ means Fertigation (water + dosing), ‘Water’ means irrigation without dosing and ‘None’ means the program is idle on that day.

DATE : 20-Dec-06		TIME : 09:06:05	
<b>IRRIGATION PROGRAM</b>			
Program:	1	Priority: --	Const. 50%
Start Time	06:30	12:30	15:00
Clock Start	2	1	1
Min. Time	01:00	--:--	--:--
Valve #	051+052	004+116	115 255
Run Time #	1	1	2 2 2 2
Dosing Prog	1	1	3 3 4 4
Day: 04/06	1	2	3 4 5 6
Dose/Water	D	W	- D W D

The figure above shows “Day: 04/06”, meaning the number of the days in the cycle is 6, and the current day is day 4. Day 1 and 5 are set to dose, day 3 is set to irrigate water only, and on days 2, 4 and 6 the program is idle.

### 5.1.1 SETTING IRRIGATION THAT IS LONGER THAN 24H

If a cycle day is 1 and the irrigation length is over 24 hours, the irrigation will repeat itself continuously, which means continuous irrigation.

*NOTE Dosing operates according to ('D-W') for the same day and not according to the setting when the irrigation has started. If an irrigation starts at 18:00 and on this day dosing is set ('D'), the irrigation crosses midnight to a day where no dosing is set ('W'), dosing stops at midnight!*

## 5.2 Influence Program

GreenField enables adjusting irrigation settings according to the following factors (labeled "Influences" on the screen):

- Solar radiation
- Amount of drainage
- Amount of fertilizer present in the drainage
- VPD
- Temperature

These Influences can adjust the following irrigation settings:

- EC
- Radiation Sum (RadS)
- Minimum Rest Time (MinT)

For example, a grower may want to increase the EC based on the Solar Radiation.

Alternatively, he may want to decrease the MinT based on the drainage.

- Using the Influences
- Setting the Influences

### 5.2.1 USING THE INFLUENCES

- Set an Influence to increase or decrease the setting.
- Changes to the setting are in percentages (for example, a 10% increase in the EC level).
- Several Influences adjust the EC setting. The final adjustment amount is based on the sum total of the different Influences.
- You enter up to three points for each Influence setting. GreenField automatically calculates the curve based on these points.
- You can program up to 15 different programs (corresponding to the 15 irrigation programs)
- After configuring an Influence, you must enable it (under ACTIVE/SOURCE).

### 5.2.2 SETTING THE INFLUENCES

1. Go to *Install* > *Device Layout*.
2. Define relays as dosing channels, as required.
3. Go to *Program* > *Irrigation*.
4. Using the arrow keys, scroll down to Screen 2. The following screen appears.

DATE: 2 -Feb-12		TIME 12:52-08
<b>IRRIGATION PROGRAM</b>		
Program: 1	Priority: --	Const. 0%
<b>INFLUENCE</b>	<b>TABLE</b>	<b>ACTIVE/SOURCE</b>
Radia./EC	<input checked="" type="checkbox"/>	NO
Drain/RadS	<input checked="" type="checkbox"/>	NO
Drain/MinT	<input checked="" type="checkbox"/>	NO
EC Drain/EC	<input checked="" type="checkbox"/>	NO
VPD/EC	<input checked="" type="checkbox"/>	NO
Temp/EC	<input checked="" type="checkbox"/>	NO

Screen 2 of 2 - In order to view the

5. Select an Influence.

The following sections detail each Influence.

- Radiation Influence on EC, page 66
- Drainage Influence on Target Radiation Sum, page 67
- Drain Influence on Minimum Time, page 68
- Drain Influence on Minimum Time, page 68
- Drainage EC Level Influence on Target EC, page 68
- VPD Influence on Target EC, page 69
- Temperature Influence on Target EC, page 70

### 5.2.2.1 Radiation Influence on EC

This function enables adjusting the EC based on solar radiation. Solar radiation increases the greenhouse temperature. Adjust the EC according to your crops' requirements.

To set the Radiation Influence:

1. In *Installation* > *Analog Input*, define a sensor as EC.
2. In *Configuration* > *Dosing Channel Configuration*, set React to EC.
3. In *Configuration* > *Dosing Configuration* > *EC Control* to Yes.
4. In *Program* > *Irrigation*, select Radia./EC.
5. Define the Radiation set points (w/m2).
6. Define the EC change in percentages.
7. Set ACTIVE/SOURCE to Yes.
8. Press Menu and confirm changes.
9. In *Program* > *Dosing Program*:
  - a. Set the Target EC.
  - b. Set EC Dosing Method to Qty.

**Example:** As sunlight increases, a crop requires higher EC levels. The following screen illustrates increasing in the EC based on radiation. Since GreenField calculates the increase in EC proportionally, there will be a 7.5% increase when the radiation reaches 60 w/m2.



DATE: 2 -Feb-12		TIME 12:52-08	
<b>IRRIGATION PROGRAM</b>			
Program: 1	Priority: --	Const.	0%
<b>INFLUENCE</b>	<b>TABLE</b>	<b>ACTIVE/SOURCE</b>	
Radia./EC	<input checked="" type="checkbox"/>	Radia.	EC
Drain/RadS	<input checked="" type="checkbox"/>	(w/m2)	(%)
Drain/MinT	<input checked="" type="checkbox"/>	40	5
EC Drain/EC	<input checked="" type="checkbox"/>	80	10
VPD/EC	<input checked="" type="checkbox"/>	100	20
Temp/EC	<input checked="" type="checkbox"/>		

Screen 2 of 2 - In order to view the

### 5.2.2.2 Drainage Influence on Target Radiation Sum

Irrigation can be triggered by the Radiation Sum (Rad Sum). This Influence enables adjusting the Rad Sum based on the amount of drainage.

To set the Drainage Influence on Rad Sum:

1. In *Program > Irrigation*, set Contr. to Rad Sum.
2. In *Installation > Digital Input*, define which digital input is the drain meter.

**NOTE** The drainage must be defined correctly! You can check the drainage meter status using Hot key 9.

3. In *Configuration > Valve Configuration* define which valve number corresponds to which drainage meter.
4. In *Configuration > Drainage Configuration*, define the drainage meter's Ratio Liter/Pulse.
5. In *Program > Irrigation*, select Drain/RadS.
  - a. Define the Drainage percentage set points.
  - b. Define the RadS percentage set points.
6. Set ACTIVE/SOURCE to Yes.
7. Press Menu and confirm changes.

**Example:** A user set irrigation to be triggered by the radiation sum. However, he wants to increase the gap between irrigations as drainage increases. The following illustration demonstrates how Rad Sum can increase. When drainage reaches 75%, the Rad Sum increases by 30%. If the Rad Sum Limit were set to 100, than at 75% drainage, it would increase to 130.

DATE: 2 -Feb-12		TIME 12:52-08	
<b>IRRIGATION PROGRAM</b>			
Program: 1	Priority: --	Const.	0%
<b>INFLUENCE</b>	<b>TABLE</b>	<b>ACTIVE/SOURCE</b>	
Radia./EC	<input checked="" type="checkbox"/>	DRAIN%	RadS
Drain/RadS	<input checked="" type="checkbox"/>	(%)	(%)
Drain/MinT	<input checked="" type="checkbox"/>	25	10
EC Drain/EC	<input checked="" type="checkbox"/>	50	20
VPD/EC	<input checked="" type="checkbox"/>	75	30
Temp/EC	<input checked="" type="checkbox"/>		

### 5.2.2.3 Drain Influence on Minimum Time

Minimum time defines the minimum break between irrigations. Even if the Rad/VPD sum limit / condition limit has been reached irrigation does not take place until this time has passed. This function enables adjusting the Minimum Time based on the drainage.

To set the Drainage Influence on the Minimum Time:

1. In *Installation* > *Digital Input*, define which digital input is the drain meter.

**NOTE** The drainage must be defined correctly! You can check the drainage meter status using Hot key 9.

2. In *Configuration* > *Valve Configuration* define which valve number corresponds to which drainage meter.
3. In *Configuration* > *Drainage Configuration*, define the drainage meter's Ratio Liter/Pulse.
4. In *Program* > *Irrigation*, select Drain/MinT.
  - a. Define the Drainage percentage set points.
  - b. Define the MinT percentage set points.
5. Set ACTIVE/SOURCE to Yes.
6. Press Menu and confirm changes.

**Example:** When drainage is low, a user wants to decrease the Minimum Time. He sets 20% drainage to a MinT of -25%. As drainage increases, the time between irrigation increases. In this scenario, if the MinT is set to 60 minutes, 40% drainage adjusts the time to 75 minutes.

DATE: 2 -Feb-12		TIME 12:52-08	
<b>IRRIGATION PROGRAM</b>			
Program:	Priority: --	Const.	0%
1			
<b>INFLUENCE</b>	<b>TABLE</b>	<b>ACTIVE/SOURCE</b>	
Radia./EC	<input checked="" type="checkbox"/>	<b>DRAIN%</b>	<b>MinT</b>
Drain/RadS	<input checked="" type="checkbox"/>	(%)	(%)
Drain/MinT	<input checked="" type="checkbox"/>	20	-25
EC Drain/EC	<input checked="" type="checkbox"/>	40	25
VPD/EC	<input checked="" type="checkbox"/>		
Temp/EC	<input checked="" type="checkbox"/>		

### 5.2.2.4 Drainage EC Level Influence on Target EC

If you have installed an EC sensor in the drainage, you can adjust the EC level based on the drainage EC level. This can be used, for example, to lower the EC level if EC in the drainage are above specifications.

To set the EC Drainage Influence on the EC:

1. In *Installation* > *Analog Input*:
  - a. Define a sensor as EC
  - b. Define a sensor as EC drain
2. In *Installation* > *Digital Input* define which digital input is the drain meter.

**NOTE** The drainage must be defined correctly! You can check the drainage meter status using Hot Key 9.

3. In Configuration > Valve Configuration define which valve number corresponds to which drainage meter.
4. In Configuration > Dosing Channel Configuration set React to EC.
5. In Configuration > Dosing Configuration > EC Control to Yes.
6. In Configuration > Drainage Configuration, define the drainage meter's Ratio Liter/Pulse.
7. In Program > Irrigation, select EC Drain/EC.
  - a. Define the EC Drain percentage set points.
  - b. Define the EC percentage set points.
8. Set ACTIVE/SOURCE to Yes.
9. Press Menu and confirm changes.
10. In Program > Dosing Program set the Target EC.

**NOTE** You can disable this function by disabling EC Control (Configuration > Dosing Configuration).

DATE: 2 -Feb-12		TIME 12:52-08	
<b>IRRIGATION PROGRAM</b>			
Program: 1	Priority: --	Const.	0%
INFLUENCE	TABLE	ACTIVE/SOURCE	
Radia./EC	<input checked="" type="checkbox"/>	EC Drain / EC	
Drain/RadS	<input checked="" type="checkbox"/>	mS/cm (%)	
Drain/MinT	<input checked="" type="checkbox"/>	1	-5
EC Drain/EC	<input checked="" type="checkbox"/>	2	-10
VPD/EC	<input checked="" type="checkbox"/>	3	-15
Temp/EC	<input checked="" type="checkbox"/>		

Screen 2 of 2 - In order to view the

**Example:** A user wants to maintain an EC level of 1.5. To this end, he measures the drainage EC. When the drainage EC level falls below 1.5, he increases the EC input. As it rises above 1.5 ms/cm, he decreases the EC level.

### 5.2.2.5 VPD Influence on Target EC

You can adjust the EC based on the VPD Sum (air temperature and humidity). As the VPD rises or falls, the program can increase or decrease the EC level according to your requirements.

1. In Installation > Analog Input:
  - a. Define a sensor as EC
  - b. Define an air temperature sensor
  - c. Define a humidity sensor

**NOTE** You can verify the EC status using Hot Key Screen, the temperature and humidity sensors status using Hot Key Screen 6.

2. In Setup > VPD Sensor Setup, enable VPD Temperature and VPD Humidity sensors.
3. In Configuration > Dosing Channel Configuration set React to EC.
4. In Configuration > Dosing Configuration > EC Control, set EC Control to Yes.
5. In Program > Irrigation, select VPD/EC.
  - a. Define the VPD sum points.

- b. Define the EC percentage set points.
- 6. Set ACTIVE/SOURCE to Yes.
- 7. In *Program > Dosing Program*:
  - a. Set the Target EC
  - b. Set EC Dosing Method to Pr. Qty.

Example: A grower wants to lower the EC level as the VPD decreases. He sets this screen to reduce the increase in EC level to match the decreasing VPD levels.

DATE: 2 -Feb-12		TIME 12:52-08	
<b>IRRIGATION PROGRAM</b>			
Program: 1	Priority: --	Const.	0%
INFLUENCE	TABLE	ACTIVE/SOURCE	
Radia./EC	<input checked="" type="checkbox"/>	VPD	EC
Drain/RadS	<input checked="" type="checkbox"/>	(kPa)	(%)
Drain/MinT	<input checked="" type="checkbox"/>	15	7
EC Drain/EC	<input checked="" type="checkbox"/>	10	4
VPD/EC	<input checked="" type="checkbox"/>	5	2
Temp/EC	<input checked="" type="checkbox"/>		

Screen 2 of 2 - In order to view the

### 5.2.2.6 Temperature Influence on Target EC

You can adjust the EC based on the air temperature. As the temperature rises or falls, the program can increase or decrease the EC level according to your requirements.

- 1. In *Installation > Analog Input*:
  - a. Define a sensor as EC
  - b. Define an air temperature sensor

*NOTE* You can verify the EC status using Hot Key Screen 4 and the temperature sensor status using Hot Key Screen 6.

- 2. In *Configuration > Dosing Channel Configuration* set React to EC.
- 3. In *Configuration > Dosing Configuration > EC Control*, set EC Control to Yes.
- 4. In *Program > Irrigation*, select Temp/EC.
  - a. Define the Temperature sum points.
  - b. Define the EC percentage set points.
- 5. Set ACTIVE/SOURCE, select the temperature sensor number.

DATE: 2 -Feb-12		TIME 12:52-08	
<b>IRRIGATION PROGRAM</b>			
Program: 1	Priority: --	NO	0%
INFLUENCE	TABLE	OUT temp	
Radia./EC	<input checked="" type="checkbox"/>	Temp 1	
Drain/RadS	<input checked="" type="checkbox"/>	Temp 2	
Drain/MinT	<input checked="" type="checkbox"/>	Temp 3	
EC Drain/EC	<input checked="" type="checkbox"/>	Temp 4	
VPD/EC	<input checked="" type="checkbox"/>	N/A	
Temp/EC	<input checked="" type="checkbox"/>	NO	

Screen 2 of 2 - In order to view the

6. In Program > Dosing Program:

- a. Set the Target EC
- b. Set EC Dosing Method to Pr. Qty.

Example: A grower's flower crop requires higher EC levels when the temperature goes above room temperature (22° C). Using this screen, he can adjust the levels accordingly.

DATE: 2 -Feb-12		TIME 12:52-08	
<b>IRRIGATION PROGRAM</b>			
Program: 1	Priority: --	Const.	0%
<b>INFLUENCE</b>	<b>PRIORITY</b>	<b>ACTIVE/SOURCE</b>	
Radia./EC	<input checked="" type="checkbox"/>	Temp	EC
Drain/RadS	<input checked="" type="checkbox"/>	(°C/F))	(%)
Drain/MinT	<input checked="" type="checkbox"/>	25	2
EC Drain/EC	<input checked="" type="checkbox"/>	27	5
VPD/EC	<input checked="" type="checkbox"/>	30	7
Temp/EC	<input checked="" type="checkbox"/>		

Screen 2 of 2 - In order to view the

### 5.3 Water Run Time

WATER RUN TIME PROGRAM				
#	Method	Water	Before	After
1	QTY.	11.000	0.300	0.400
2	TIME	01:05:00	00:10:00	00:16:00
3	QTY.	3.000	0.000	0.000
4	QTY.	5.000	0.000	0.000
5	QTY.	6.000	0.000	0.000
6	QTY.	8.000	0.000	0.000
7	QTY.	11.000	0.000	0.000
8	QTY.	12.000	0.000	0.000
9	QTY.	13.000	0.000	0.000
10	QTY.	14.000	0.000	0.000
11	QTY.	16.000	0.000	0.000

The WATER RUN TIME table has 60 “floating” programs; each program can be configured so that irrigation water is given in time (HH:MM:SS) or in quantity (m<sup>3</sup> or gallon, depending on definitions in the System Setup, page 108). The programs can later be connected to a valve or a group of valves through the Irrigation Program. Each program includes water, water before and water after settings.

- **Method:** Select the method (QTY. Or Time) with the up/down arrow keys and press ENTER to confirm.
- **Water:** Set quantity / time for each program (liter or gallon). The water setting is the total quantity / time including the Before and After settings.
- **Before:** Set quantity/time without dosing at the beginning of each irrigation cycle.
- **After:** Set quantity/time without dosing at the end of each irrigation cycle.

*NOTE Before and After settings are deducted from the Water settings. Therefore Water quantity/time must be larger or equal to the Before and After settings.*

## 5.4 Dosing

DOSING PROGRAM				
Program:	1	EC Pre-Control:	ON	
INJECTION PER DOSING CHANNEL				
1	2	3	4	
EC	EC	ACID	PASSIV	---
3.00	5.00	6.00	5.00	---
Target EC			2.00	
Target PH			6.00	
Target EC Pre-Control			1.00	
Passive Dosing Method			QTY.	
EC Dosing Method			P.QTY	
PH Dosing Method			P.QTY	

GreenField includes 10 predefined dosing programs. Each program consists of injection methods, quantities and EC/pH target values. Each channel is completely independent and can be set to give a different amount. Overlapping between the various channels is possible.

- Dosing Program
- Dosing Injection Methods

### 5.4.1 DOSING PROGRAM

- **Program:** Select a program by entering the program number, and confirm by pressing ENTER.
- **EC Pre-Control:**
  - **On:** EC Pre-Control is active for this Dosing program.
  - **Off:** EC Pre-Control is not active for this Dosing program; the EC Pre-Control valve will be shifted towards the fresh water source.

#### INJECTION PER DOSING CHANNEL

- **Dosing channel number:** 1 to 8.
- **Reaction:** A read only line indicating the purpose of the channel;
  - **EC:** the channel is used to increase measured EC, meaning it will be opened more when the measured EC is lower than the set EC.
  - **pH:** the channel is used to decrease measured pH, meaning it will be opened more when the measured pH is higher than the set pH.
  - **Passive:** the channel does not respond to changes in measured EC/pH, meaning it will be opened as set in the Dosing program regardless of the EC/pH values.
  - **Alkali:** the channel is used to increase measured pH, meaning it will be opened more when the measured pH is lower than the set pH.
- **Quantity / Time:** Set the Quantity / Time to be injected for each dosing channel. The injection method (proportional, quantity, time, etc.) can be set separately for each use of the channel (EC, pH, Passive).
- **Target EC:** Set the required EC target value, only visible if EC control or EC alarms are active, see table 1.3.
- **Target pH:** Set the required pH target value, only visible if pH control or pH alarms are active, see table 1.3.

- **Target EC Pre-Control:** Set the required EC Pre-Control target value (only visible if EC-Pre Control is set to On, see EC-Pre Control above).
- **Passive Dosing Method:** Set the required injection method of the Passive dosing channels (see [Dosing injection method](#)).
- **EC Dosing Method:** Set the required injection method of the EC dosing channels (see [Dosing injection method](#)).
- **pH Dosing Method:** Set the required injection method of the Acid and Alkali dosing channels (see [Dosing injection method](#)).

## 5.4.2 DOSING INJECTION METHODS

1. **P.Qty (1/1000):** Proportional quantity. Each dosing channel can be set to give a different amount. The set amount is 1 part (Liter or Gallon) fertilizer/Acid per 1000 parts (m<sup>3</sup>/h or 1000 Gallons) of water.

For example:

- Channel 1 is set to 5.0 (liters or gallons).
- Set water quantity is 3.5 (m<sup>3</sup>/h or 1000 gallons).

This setting actually means that 5.0 (liters or gallons) of fertilizer will be mixed with each cubic meter (1000 gallons respectively) of water passing through the system.

The total quantity of fertilizer that will be given is  $5.0 * 3.5 = 17.5$  liters (Gallons).

2. **P.Time (hh:mm):** Proportional time. Each dosing channel is given the time to fertilize independently. The GreenField divides this time equally within the given irrigation time (quantity) set in [1.2 WATER RUN TIME](#).

For example:

- Dosing channel -1- is set to 00:10, dosing channel -2- is set to 01:00.
- Set irrigation time is 03:00 hours.

The GreenField will proportionally divide the set fertigation time for each dosing channel across the set irrigation time (quantity).

Dosing channel -1- will be on for a few pulses; their total time will be 10 min.

Dosing channel -2- will be on for a few pulses (not necessarily the same amount). Their total time will be 60 min.

3. **Time. (hh:mm):** Each dosing channel is given the time to fertigate. Dosing will be done in one bulk that will start after water, before time/quantity has elapsed.

4. **Qty. (Liters or Gallons):** Quantity. Each dosing channel is given the amount to be injected. Dosing will be done in one bulk or spread throughout the irrigation, depending on settings in the screen [7.7 DOSING CONFIGURATION](#), line [Dosing by QTY. Method](#). Dosing will start after water, before time/quantity has elapsed.

To choose a method, place the cursor on the METHOD column and press ENTER. A small window will appear:

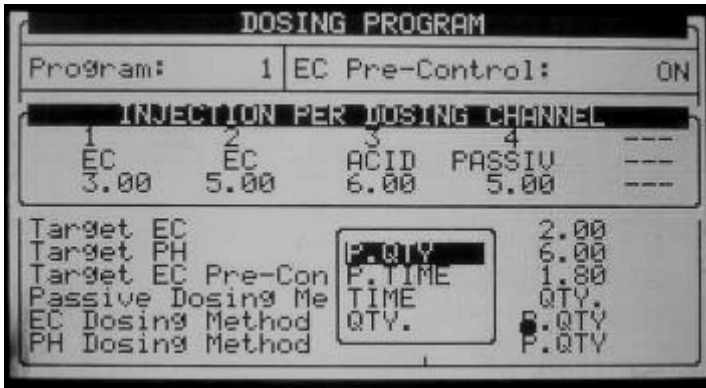

Select the method with the arrow keys and press ENTER to confirm.

*NOTE* The EC/pH columns will not be visible if EC/pH control and EC/pH alarms are marked 'No'.

### 5.5 Ext. Condition

The Ext Condition program allows starting and/or stopping irrigation according to dry contacts or analog sensor. In addition, it is possible to define an output called Cond. This output will be active whenever the condition program settings are met. This enables using the condition program to start any external device.

Refer to Analog Input 1-2, page 139 for details on configuring this window.

EXTERNAL CONDITION PROGRAM			
#	From hh:mm	To hh:mm	Start An. Dry Cont.
1	10:00	12:00	Ana. Sen 1
2	11:00	12:00	Dry Con 1
3	12:00	13:00	Dry Con 1
4	--:--	--:--	<NONE>
5	--:--	--:--	<NONE>
6	--:--	--:--	<NONE>
7	--:--	--:--	<NONE>
8	--:--	--:--	<NONE>

EXTERNAL CONDITION PROGRAM			
#	Trigger Type	Stop An. Dry Cont.	Oper. to Start
1		Ana. Sen 2	---
2	Ana. Sen 1	Dry Con 2	---
3	Ana. Sen 2	Dry Con 14	---
4	Ana. Sen 3	<NONE>	---
5	Ana. Sen 4	<NONE>	---
6	Ana. Sen 5	<NONE>	---
7	Ana. Sen 6	<NONE>	---
8		<NONE>	---

EXTERNAL CONDITION PROGRAM			
#	Oper. to Start	Start Value	Oper. to Stop
1		25	=
2	---	---	---
3	<	---	---
4	<=	---	---
5	=	---	---
6	>	---	---
7	>=	---	---
8	---	---	---

- From (hh:mm): Set the start time of the condition program.
- To (hh:mm): Set the end time of the condition program

The condition program will only be operational in the defined time window (between start "From" to end "To" times). Each condition program can be operational on different hours.



- **Start An. Dry Con.:** Set the analog sensor or dry contact number for starting the irrigation.
- **Trigger Type:** Choose one of three trigger types:
  - **One Shot:** If the Start Dry Contact is closed for more than 20 seconds the associated irrigation program will be started. The contact must open and close to initiate irrigation.
  - **Multi shot:** If the Start Dry Contact is closed for more than 20 seconds the associated irrigation program will be started. If the contact is still closed when the irrigation has finished, irrigation will be initiated.

*NOTE Notice that the Start Dry Contact does not necessarily have to open and close in order to initiate irrigation. It simply has to be closed when the irrigation has finished.*

- **Only If On:** The associated Irrigation program will be turned on, providing the Start Dry Contact has been closed for more than 20 second and will remain on as long as the contact is closed.
- **Stop An. Dry Con.:** Set the analog sensor or dry contact number for stopping the irrigation. Since the Stop Dry Contact is “stronger” than the Start Dry Contact, the associated irrigation program will not be started as long as the Stop Dry Contact is closed.

The following is a description graph of the Condition program:

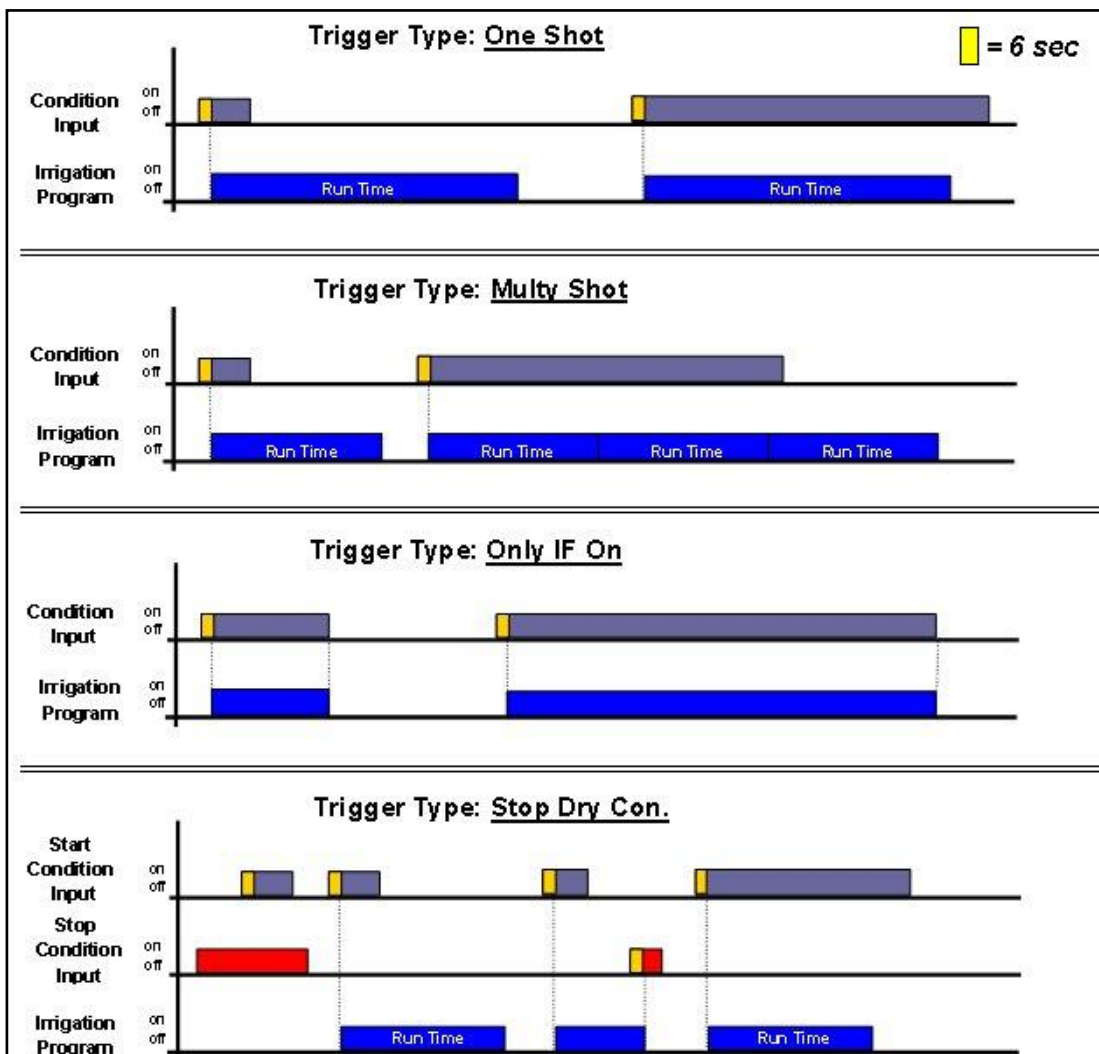

### 5.5.1 DEFINING ANALOG SENSORS

1. Go to *Installation > Analog Input 1 (8.4)*.
2. Set Sensors 1 and 2 to the same channels to which the sensors were connected.

ANALOG INPUT No. 1			
	Channel 1	Input Function	No.
Local	1	< None >	--
Local	2	< None >	--
Local	3	< None >	--
Local	4	< None >	--
Local	5	< None >	--
Local	6	< None >	--
Local	7	< None >	--
Local	8	Analog Sensor	1
Local	9	Analog Sensor	2

3. Go to *Setup > Analog Conversion Table*.
4. Define the sensor type (ECh2o 5).

ANALOG CONVERSION TABLE			
Num.	Sensor Type	Min Value	Max Value
1	ECh20	0.0	60.0
2			

5. Go to *Test > Analog Sensor*.
6. Test the sensor values.

ANALOG SENSOR		
No.	Type	Value
1	<NONE>	0.000
2	ECh20	19.355
3	<NONE>	0.000
4	<NONE>	0.000

### 5.6 Agitator

The agitator is used to mix the fertilizers and acid in the storage tanks in order to prevent the occurrence of sediment.

AGITATOR		
	On mm:ss	Off mm:ss
Dosing Active	01:00	10:00
Dosing Not Active	02:00	30:00

- **Dosing Active:** Definition of the On and Off times of the agitator when dosing is taking place:
  - **On:** Define the required mixing time.
  - **Off:** Define the required time between mixing.
- **Dosing Not Active:** definition of the On and Off times of the agitator when dosing is not taking place:
  - **On:** Define the required mixing time.
  - **Off:** Define the required time between mixing.

## 5.7 Selector

This screen enables the use of various fertilizer stock tanks. Every dosing program can be connected to one (or more) selectors. Using the selector outputs you can choose which fertilizer stock will be connected to each dosing program.

SELECTOR					
Dosing Prog.	S1	S2	S3	S4	S5
1	✓	•	•	•	•
2	•	•	✓	•	•
3	•	•	•	✓	•
4	•	•	•	•	✓
5	✓	•	•	•	•
6	•	✓	•	•	•
7	•	•	✓	•	•
8	•	•	•	✓	•
9	•	•	•	•	✓
10	•	•	•	•	✓

Use the '+/-' keys to assign a selector to a dosing program.

## 5.8 Filter Flushing

Configuring the required process for filter flushing is allowed. Define the following before configuring this screen:

- [Stop Irrigation During Filter Flushing:](#) Yes/No
- [Stop Dosing During Filter Flushing:](#) Yes/No

FILTER FLUSHING PROGRAM	
Time Between Flushing (hh:mm)	06:00
Flushing Time (mm:ss)	01:00
Delay Between Filters (mm:ss)	00:30
Delta Pressure (Digital)	YES
Delta Pressure Value (bar)	0.5
Delay Delta Pressure (mm:ss)	00:06
Delta Pressure Reiteration	3
Dwell Time Main (mm:ss)	01:00

- **Time Between Flushing (hh:mm):** Time interval between two consecutive Flushing cycles. The time is only counted during irrigation.  
Example: If the time between flushing is set to 01:00 it means that a flushing cycle will be activated after 1 hour of irrigation (regardless of DP status).  
If set to zero (---:--), flushing will only take place if triggered by a DP.
- **Flushing Time (mm:ss):** Flushing time of each Filter (output).
- **Delay Between Filters (mm:ss):** The delay time between flushing of one filter to the next. This time is usually used to allow pressure buildup.
- **Delta Pressure (Digital):** Define whether filter flushing can be triggered due to digital Delta Pressure (Yes / No).
- **Delta Pressure Value (bar):** Define the Delta Pressure of the inlet pressure sensor (Pin) and outlet pressure sensor (Pout), at which filter flushing will be triggered (Only relevant when the application consists of analog Pin and Pout sensors).
- **Delay Delta Pressure (mm:ss):** Define the time that the Delta Pressure (digital or value) must be active before a filter flushing cycle will be triggered. This time is usually used to prevent unnecessary flushes from taking place.
- **Delta Pressure Reiteration:** Number of consecutive filter flushing cycles triggered by the Delta Pressure that can take place without any breaks, before the GreenField will generate an alarm indicating that the Delta pressure sensor is defective. The GreenField will then ignore the Delta Pressure and will continue flushing according to the set Time Between Flushing only, until the alarm is reset.
- **Dwell Time Main Filter Valve (mm:ss):** Define for how much time the main filter valve must be on before the filter flushing cycle is started. This output is typically used to control a pressure-sustaining valve or to start a booster pump.

## 5.9 Cooling

The Cooling/Humidification program is used to keep the temperature below a set value and/or the humidity above a set value. Each program can be set to maintain temperature or humidity as its first priority.

Five Cooling programs are available with two periods in each program. The periods can be defined to overlap, thus creating "dynamic" cooling or humidification.

Different temperature and humidity sensors can be connected to each program.

The *Status* can be defined as *Cooling* or *Humidification*, the aim of the status field is to help the user to understand the process that should take place by placing the related set

point first (i.e. above  $t^\circ$  when the status is cooling OR below RH when the status is Humidification)

*NOTE* There are a few steps that should be defined prior to this screen: see Cooling Configuration.



- **Program:** Choose the required program 1 to 8, press ENTER to confirm.
- **Status:** define whether the program's first priority is maintaining temperature or humidity.
- **Cooling:** the program's priority is temperature. If the two periods are overlapping and there are different settings in each period, dynamic cooling will take place.

**Example:**

- **Settings:**
  - Period 1 is set between 08:00 to 16:00, The cooling process should work above temperature of 30°C and Below RH of 80%.
  - Period 2 is set between 08:00 to 16:00, The cooling process should work above temperature of 40°C and Below RH of 80%
  - On time is fixed to 30 sec in both periods.
  - Off time is 3:00 minutes which relates to the lowest temperature setting (30°C)
  - Off time is 1:00 minute which relates to the highest temperature setting (40°C)

**Scenarios:**

- Time is 10:00, the measured temperature is 35°C and the measured relative humidity is 65%, the cooling valve will be open for 30 seconds and close for 2:00 minutes in a continuous cycle.
- Time is 12:00, the measured temperature is 30°C and the measured relative humidity is 65%, the cooling valve will be open for 30 seconds and close for 3:00 minutes in a continuous cycle.
- Time is 14:00, the measured temperature is 40°C and the measured relative humidity is 50%, the cooling valve will be open for 30 seconds and close for 1:00 minutes in a continuous cycle.
- Time is 15:00, the measured temperature is 35°C and the measured relative humidity is 85%, the cooling valve will not be open since the measured relative humidity is above the maximum allowed (80%).

*NOTE* If more than one cooling valve is defined, the off time will take place after the last valve in the sequence (Cooling valve #2, in the above screen). Between the cooling valves there is no delay and they are working in sequence, from the first valve on the left side to the last one.

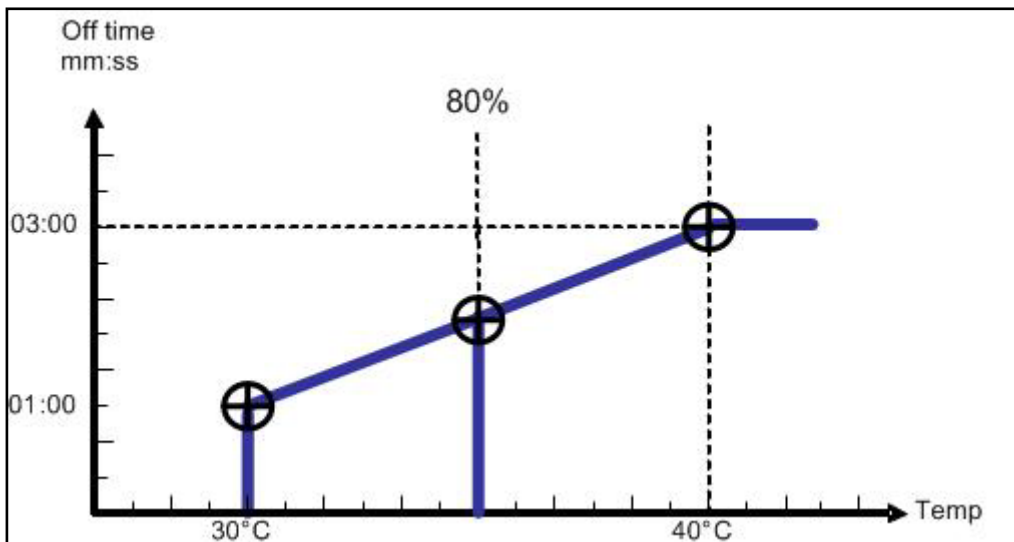

**NOTE** If the time is relevant only for a certain period, only its settings will define operation. If humidity is above the lowest value of the two periods, cooling will not take place.

- From (hh:mm): Set the start time of the Cooling / Humidification program.
- To (hh:mm): Set the end time of the Cooling / Humidification program

**NOTE** The program will only be operational in the defined time window (between start "From" to end "To" times). Each program can be operational on different hours.

- Above t° / Below RH
  - Above t° (when status is cooling): Start cooling above this temperature. Cooling will stop if the temperature drops below the internal dead-band of 0.5°C. For example if set to 30°C cooling will start when the temperature is above 30°C and will stop when it drops below 29.5°C. °
  - Below RH (when status is humidification): Start humidification below this humidity. Humidification will stop if the humidity goes above the internal dead-band of 1%. For example, if set to 80% humidification will start when the humidity is below 80% and will stop when it is above 81%.
- Below RH / Above t°
  - Below RH (when status is cooling): Stop cooling above this humidity. Cooling will be resumed when the humidity drops below the internal dead-band of 2%. For example, if set to 80% cooling will stop when the humidity is above 82% and will be resumed when the humidity drops below 80%.
  - Above t° (when status is humidification): Stop humidification when the temperature is below this temperature. Humidification will be resumed when the temperature goes above the internal dead-band of 0.5°C. For example, if set to 25°C humidification will stop when the temperature drops below 24.5°C and will be resumed when it goes above 25°C.
- On (hh:mm:ss): Define the On time of the Cooling valve. If On time is set to zero the Cooling valve will not be opened.
- Off (hh:mm:ss): Define the Off time of the Cooling valve. If Off time is set to zero the Cooling valve will be constantly On.
- Cool #: Assign cooling valves to this program. The assigned cooling valves will be operated sequentially in groups. The number of groups (different cooling

programs) which can be operated simultaneously (maximum cooling parallel) is defined in screen [6.2 SYSTEM SETUP](#).

- Temp. Sens.: Assign Up to two temperature sensors for this program.
- Hum. Sens.: Assign up to two humidity sensor to this program.

If there is a malfunction in one of the temperature sensors, a message will be displayed, and that sensor will be taken out of the average temperature calculation. If all the temperature sensors are out of order, the controller will operate according to the first active line. If you would like to operate the program by time only, set as follows:

Set Status to cooling or humidification (not important). Set the Above t°. and Below RH to '0'. Define the required On and Off times and the program will work accordingly within the set time frame.

## 5.10 Misting

The misting program is a time scheduler used to open/close a misting valve or any other device that is operated sequentially. Up to 40 misting programs can be preset. Note that there are a few steps that should be defined prior to this screen, see the Misting Configuration Table on page 135.

#	No.	Start hh:mm	End hh:mm	On hh:mm:ss	Off hh:mm:ss
1	1	08:00	18:00	00:00:30	00:10:00
	2	10:00	19:00	00:00:50	00:13:00
	3	11:00	18:00	00:01:00	00:16:00
	4	08:00	13:00	00:00:55	00:20:00
	5	09:00	20:00	00:00:18	00:30:00
	6	10:00	00:00	00:01:02	00:15:00
	7	--:--	--:--	--:--:--	--:--:--
	8	--:--	--:--	--:--:--	--:--:--
	9	--:--	--:--	--:--:--	--:--:--
	10	--:--	--:--	--:--:--	--:--:--

- Mist No.: Assign a mist valve to the program. It is possible to associate the same misting valve to several programs.
- Start (hh:mm): Set the start time of the Misting program. If start time is set to 00:00, it will automatically be changed to --:--, meaning the program is not operational.
- End (hh:mm): Set the end time of the Misting program. The Misting program will only be operational in the defined time window (between Start to End times). Each Misting program can be operational on different hours.
- On: Define the On time of the misting valve. If On time is set to zero the MISTING valve will not be opened.
- Off: Define the Off time of the MISTING valve. If Off time is set to zero the MISTING valve will be constantly On.

The table is sorted according to mist number as the first priority, and start time as the second priority. The Mist No. will always appear in groups in an increasing order so that the orientation is quick and easy.

Each mist group has an inside start time sorting, so that a later start is moved to the end of the group. If you delete a row (by zeroing the Mist .No.) it will be moved to the end of the

table and the rest of the rows will move one step up. Pressing the menu key does this sorting.

*NOTE When misting is on all related devices (e.g. misting valve, main valve and pump) are operational. When misting is off, only the pump continues to operate*

## 5.11 Water Heating

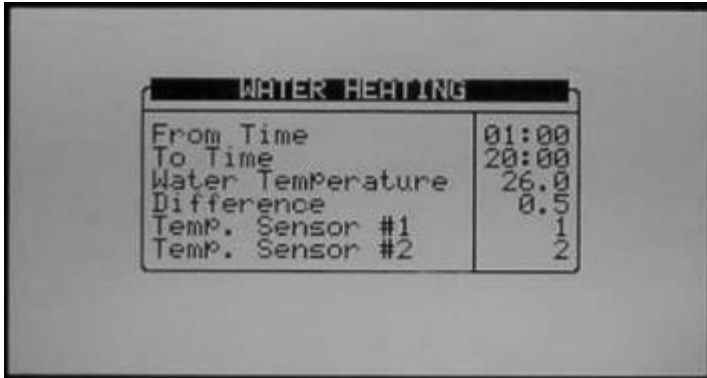

WATER HEATING	
From Time	01:00
To Time	20:00
Water Temperature	26.0
Difference	0.5
Temp. Sensor #1	1
Temp. Sensor #2	2

Water Heating operates according to temperature within a set time frame (between start “From Time” to end “To Time”) and can be used to increase irrigation water temperature or prevent frost.

- **From Time (hh:mm):** Set the start time of the water-heating program.
- **To Time (hh:mm):** Set the end time of the water-heating program.
- **Water Temperature:** Water heating will be activated when the temperature drops below this value.
- **Difference:** Dead-band for stopping water heating. When the water temperature reaches the set Water Temperature + Difference, water heating will be stopped.

For Example: Water temperature is 25°C and the difference is 2°C. Water heating will start when the temperature drops below 25°C and will stop when it is 27° or above.

The Minimum difference is 0.3°C and the default is 0.5°C.

- **Temp. Sensor 1/2:** Assign up to 2 temperature sensors. If you assign 2 sensors, the GreenField will operate according to their average.



# 6 Manual Operation Menu



- Irrigation Pause, page 83
- Start/Stop Program, page 84
- Start/Stop Valve, page 84

## 6.1 Irrigation Pause

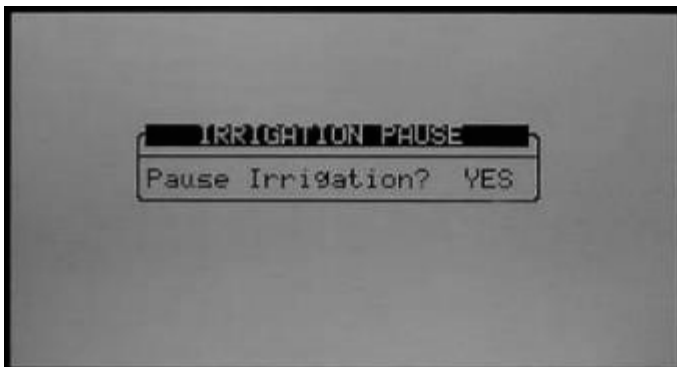

- **Pause Irrigation (Yes/No):** Set Yes and press Enter to confirm; all irrigations will be paused until the value will be set back to No. When the system is released from Pause mode it will complete all irrigations that should have taken place when it was paused.

## 6.2 Start/Stop Program



1. Enter a program number to start and press ENTER.

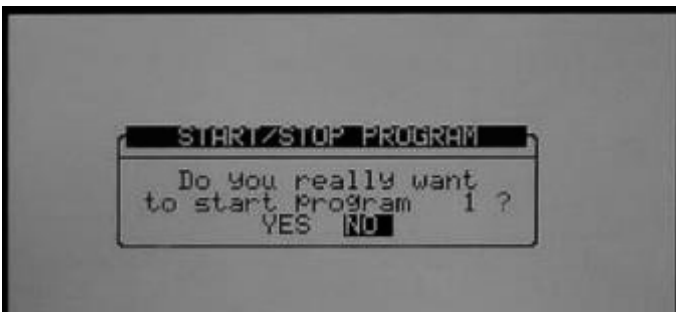

2. Select 'Yes' to confirm your choice and start the relevant program.
3. When you enter the Start/Stop screen during irrigation you will be asked whether you wish to stop the active program. Choose Yes to stop the program.

### 6.2.1 START/STOP VALVE

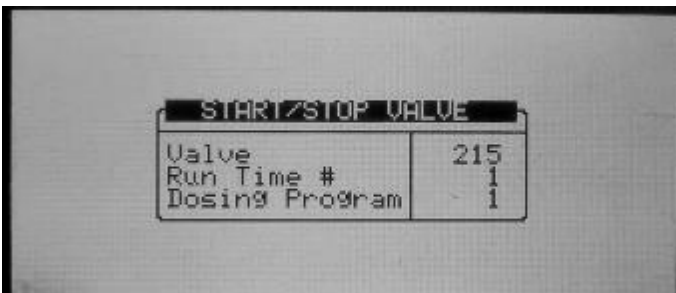

1. Enter a valve number, Run Time program and (optional) dosing program, press Enter to confirm and then press the menu button to open the confirmation screen.

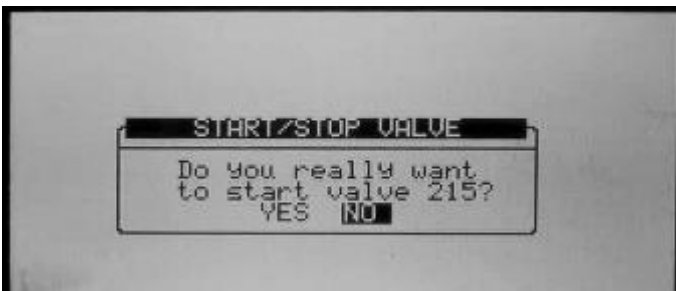

2. Select 'Yes' if you wish to start the relevant valve.
3. When you enter the Start/Stop screen and a valve is active you will be asked whether you wish to stop the relevant valve. Choose Yes to stop the valve.

## 6.3 Filter Flushing

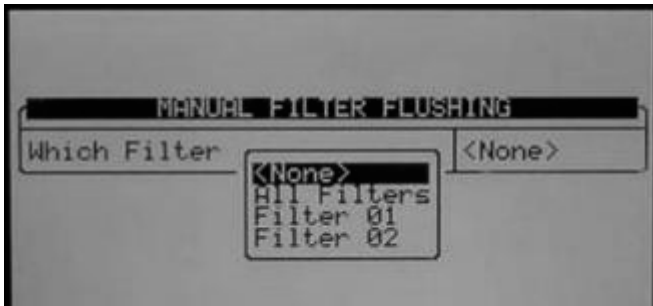

To flush filters manually, follow the prompts, select which filters to flush with the arrow keys and press ENTER to confirm. You can flush all filters or individual filters (without Pump or Main valve operation)

# 7 Alarm Menu

The Alarm Menu allows configuration of alarms, alarm actions and reset active alarms. It also provides history of previous alarms. The alarm menu is divided into EC/pH related alarms and none EC/pH related alarms.



- Alarm Reset, page 86
- History, page 87
- Alarm Definition, page 87
- Alarm Setting, page 89
- EC/pH Alarm Definition, page 91
- EC/pH Alarm Setting, page 91
- Radio Sys. Alarm Definition, page 92
- Radio Sys. Alarm View, page 92

## 7.1 Alarm Reset

This table shows active alarms and failures. The upper section allows you to cancel failures and reset alarms.

Period of Automatic Reset allows you to set a time in which the GreenField will try to reset the alarms automatically and complete the uncompleted processes.

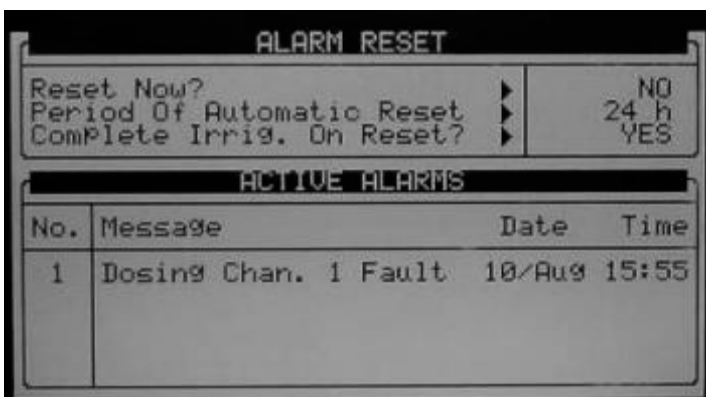

## 7.2 History

Every alarm from the last reset will have a record in this table (Up to 250 alarms).

ALARM HISTORY					
No.	Message		Date	Time	
1	Ext. Box #1	Comm fail	24/Dec	21:41	
2	Ext. Box #2	Comm fail	24/Dec	21:41	
3	Ext. Box #3	Comm fail	24/Dec	21:41	
4	Water 2	Leak	24/Dec	23:55	
5	Low Flow	Valve #215	26/Dec	13:07	

## 7.3 Alarm Definition

ALARM DEFINITION	
Water Fill Up (min)	2
Water Leak (m3)	1.000
Water Leak Period (hh:mm)	00:30
Identify Leak-Subtr. Meter?	NO
Dosing Channel Leak Delay(s)	3
Dosing Channel Leak (Pulse)	10
Dosing Flow Difference (%)	25
Missing Pulses For No Flow	10
Stop System Cons.Flow Alarm	2.500
# of Irrig. Without Drainage	3
Low Pressure Alarm (bar)	2.500
No. Of Short Circ. To Pause	3

ALARM DEFINITION	
Dosing Channel Leak Delay(s)	3
Dosing Channel Leak (Pulse)	10
Dosing Flow Difference (%)	25
Missing Pulses For No Flow	10
Stop System Cons.Flow Alarms	2.500
# of Irrig. Without Drainage	3
Low Pressure Alarm (bar)	2.500
No. Of Short Circ. To Pause	3
Short Output Level (60-350)	300
Short O. Level EXT1 (60-350)	300
Short O. Level EXT2 (60-350)	300
Short O. Level EXT3 (60-350)	300

- **Water Fill Up (min):** Time for line fill up. The system will ignore high flow and will not generate a High Flow alarm during this period.
- **Water Leak (m3 or Gal):** Quantity of water to trigger a water leak alarm. The quantity is either in m3 or gallon depending on the choice of volume units.
- **Water Leak Period (hh:mm):** Time frame to measure the water-leak quantity. If it takes the system more time than indicated here to measure the water-leak quantity, the system will not generate an alarm.
- **Identify Leak-Subtr. Meter?:** Choose whether to identify (Yes / No) when a water leak occurs in a subtracting water meter (relevant only when operating by water source).

- **Dosing Channel Leak Delay (s):** Delay after dosing channel is stopped before the system starts measuring dosing channel Leak. This feature is usually used to cope with problems regarding hydraulic pumps that work with dosing meters.
- **Dosing Channel Leak (Pulse):** Number of pulses generated by the dosing meter during which the dosing channel should be idle before the system will generate a dosing leak alarm.
- **Dosing Flow Difference (%):** Difference between calculated and measured dosing channel flow above or below which an alarm will be generated. For example, if the calculated dosing channel flow is 100 l/h, and the actual flow is less than 70 l/h or above 130 l/h an alarm will be generated (depending on this parameter's value. This example refers to a parameter set to 30).
- **Missing Pulses For No Flow:** Number of missing pulses before the system will generate a No Flow alarm. The system calculates the expected time between pulses according to the calculated flow rate and the volume per pulse of the water meter; if more time has passed than expected for the set number of missing pulses the system will generate a No flow alarm.
- **Stop System Consecutive Flow Alarms:** Number of consecutive flow alarms of the same type (high flow, low flow etc.) but different valves before the system is stopped. This setting is used to pause the system when there is a general malfunction that occurs in a few valves (or valve groups). The number on the right side of the table indicates the number of consecutive flow alarms. Reaching set point activates a Stop System Consecutive flow alarm.

**CAUTION** *Warning: When the water meter does not generate pulses and “missing pulses for NO FLOW” or “Max consecutive flow alarms” are in ignore mode, irrigations by quantity will be “stuck” until stopped manually.*

- **# of Irrigations Without Drainage:** Number of irrigations given without measuring drainage, above which an alarm will be generated. This alarm usually indicates that the irrigation quantity is too small or that there is a malfunction in the drainage measurement.
- **Low Pressure Alarm (bar/psi):** Define the minimum allowed pressure, under which an alarm will be generated.
- **Num. Of Short Circ. To Pause:** Number of short circuit alarms measured before the system is paused. This setting is used to pause the system when a general malfunction occurs causing several outputs to short circuit.
- **Short Output Level (60-350):** Define the A/D threshold value to be considered as a short circuit (for further instructions see GreenField – Part 2 > Appendix 1 – General > Short Circuit Control).<sup>1</sup>

The following parameters will be visible only if an Extension box is defined;

- **Short O. Level EXT1 (60 – 350):** Define the A/D threshold value to be considered as a short circuit for Extension box no. 1 (for further instructions see GreenField – Part 2 > Troubleshooting > Short Circuit Control).<sup>1</sup>
- **Short O. Level EXT2 (60 – 350):** Define the A/D threshold value to be considered as a short circuit for Extension box no. 2 (for further instructions see GreenField – Part 2 > Troubleshooting > Short Circuit Control).<sup>1</sup>
- **Short O. Level EXT3 (60 – 350):** Define the A/D threshold value to be considered as a short circuit for Extension box no. 3 (for further instructions see GreenField – Part 2 > Troubleshooting > Short Circuit Control).<sup>1</sup>

---

<sup>1</sup> This value is set according to the table 5.1 parameter 'Load output level' parameter.

---

## 7.4 Alarm Setting

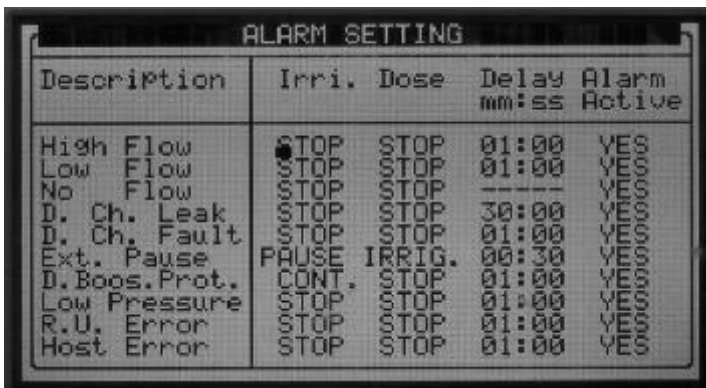

Description	Irri.	Dose	Delay mm:ss	Alarm Active
High Flow	STOP	STOP	01:00	YES
Low Flow	STOP	STOP	01:00	YES
No Flow	STOP	STOP	-----	YES
D. Ch. Leak	STOP	STOP	30:00	YES
D. Ch. Fault	STOP	STOP	01:00	YES
Ext. Pause	PAUSE	IRRIG.	00:30	YES
D. Boos.Prot.	CONT.	STOP	01:00	YES
Low Pressure	STOP	STOP	01:00	YES
R.U. Error	STOP	STOP	01:00	YES
Host Error	STOP	STOP	01:00	YES

The Alarm Setting table allows you to define the required response for failures recognized by the GreenField:

- **STOP:** Stop irrigation and/or dosing for current valve (or valve group) and continue to the next valve (or valve group).
- **CONT:** Continue irrigation and/or dosing for the valve (or valve group) that caused the alarm. This option actually means that the system will generate an alarm but will not take action.
- **Delay (mm:ss):** Define the period the failure must be active before the GreenField will generate an alarm and will take action.
- **Alarm Active:** Define whether the alarm output should be triggered by the appropriate alarm.

*NOTE* An alarm will be generated on the GreenField screen even if the controller has been set to continue (ignore) or the alarm output has been set as not active (or not defined at all).

*NOTE* The GreenField will not reset a "R.U. Error" alarm once the error has been corrected in the remote unit; the alarm will only be reset upon Period of automatic reset or when reset manually by the user (Reset now function).

*NOTE* Refer to Analog Output Test, page 50 for information on the Analog Output Test.

### 7.4.1 ANALOG OUTPUT ALARM GENERATION

GreenField generates Alarm Output Alarms if:

- GreenField uses the Dosing Program

DATE : 1-Mar-18 TIME : 15:32:45

**IRRIGATION PROGRAM**

Program: 1	Priority: --	Const. 0%
Start Time	15:06	
Clock Start	10	
Min. Time	00:05	
Valve #	008 009 010	
Run Time #	1 1 1	
Dosing Prog	1 2 3	
Day: 01/01	<input checked="" type="checkbox"/>	
Dose/Water	D	

- Dosing Program Quantity is defined

**DOSING PROGRAM**

Program: 2

**INJECTION PER DOSING CHANNEL**

1	2	3	4
EC	EC	ACID	PASSIV
100.00	125.00	160.00	0.00

Passive Dosing Method	QTY.
EC Dosing Method	QTY.
PH Dosing Method	QTY.

- No analog valve is physically connected

If these three conditions are present:

- GreenField ceases the Irrigation-Fertigation
- An alarm appears on the Main Screen

**ACTIVE IRRIGATION**

	SET	ACTUAL	LEFT
CYCLE	10	2	8
WATER	00:15:00	00:00:00	00:15:00
FLOW	25.000	25.000	
EC	not set	---	
PH	not set	---	

**STATUS**

PROGRAM: 1 15:25:15  
 VALVE: 10 1-Mar-18

**ACTIVE**

IRRIGATION  
 DOSING

**1 MESSAGE**

Dosing Chan. 3 Fault

**ALARM**

ALARM



## 7.5 EC/pH Alarm Definition

EC/pH ALARM DEFINITION	
Delta EC Low	0.0
Delta EC High	0.0
Delta pH Low	0.0
Delta pH High	0.0
Delta EC-Pre Control Low	0.0
Delta EC-Pre Control High	0.0
Emergency EC High(1 Min.Dly)	4.0
Emergency pH Low (1 Min.Dly)	4.0

- **Delta EC Low:** If the measured EC value is lower than the target value minus Delta EC Low, the system will generate a Low EC Alarm.
- **Delta EC High:** If the measured EC value is higher than the target value plus Delta EC High, the system will generate a High EC Alarm.
- **Delta pH Low:** If the measured pH value is lower than the target value minus Delta pH Low, the system will generate a Low pH Alarm.
- **Delta pH High:** If the measured pH value is higher than the target value plus Delta pH High, the system will generate a High pH Alarm.
- **Delta EC Pre-Control Low:** If the measured EC Pre-Control value is lower than the target value minus Delta EC Pre-Control Low, the system will generate a Low EC Pre-Control Alarm.
- **Delta EC Pre-Control High:** If the measured EC Pre-Control value is higher than the target value plus Delta EC Pre-Control High, the system will generate a High EC Pre-Control Alarm.
- **Emergency EC High (1 minute delay):** If the measured EC is higher than the value set here for more than 1 minute, the system will be stopped. This setting should be used to protect the plants/system and should generally be higher than the EC High Alarm based on the dosing-program target value plus the Delta EC High.
- **Emergency pH Low (1 minute delay):** If the measured pH is lower than the value set here for more than 1 minute, the system will be stopped. This setting should be used to protect the plants/system and should generally be lower than the pH Low Alarm based on the dosing-program target value minus the Delta pH Low.

## 7.6 EC/pH Alarm Setting

EC/pH ALARM SETTING				
Description	Irri. Dose	Delay	Alarm	Active
EC High/Fail	STOP	STOP	01:00	YES
EC Low	STOP	STOP	01:00	YES
pH High	STOP	STOP	01:00	YES
pH Low/Fail	STOP	STOP	01:00	YES
EC-P.Hi/Fail	STOP	STOP	01:00	YES
EC-Pre. Low	STOP	STOP	01:00	YES
E.Tank Fresh	STOP	STOP	01:00	YES
E.Tank Drain	STOP	STOP	01:00	YES
EC Sen. Dif.	STOP	STOP	01:00	YES
pH Sen. Dif.	STOP	STOP	01:00	YES

The EC/pH alarm setting table allows you to define the desired response for EC/pH related failures recognized by the GreenField:

- **STOP:** Stop irrigation and/or dosing for current valve (or valve group) and continue to the next valve (or valve group).
- **CONT:** Continue irrigation and/or dosing for the valve (or valve group) that caused the alarm. This option actually means that the system will generate an alarm but will not take action.
- **Delay (mm:ss):** Define the period the failure must be active before the GreenField will generate an alarm and will take action.
- **Alarm Active:** Define whether the alarm output should be triggered by the appropriate alarm.

## 7.7 Radio Sys. Alarm Definition

RADIO SYS. ALARM DEFINITION			
Alarm Type	Delay mm:ss	Active	Inform
RTU			
Vbatt failure	00:00	YES	YES
Vbatt low	00:00	NO	YES
Vbatt warn	00:00	NO	YES
Cap failure	00:00	NO	YES
Card failure	00:00	NO	YES
I/O Open	00:00	NO	YES
I/O Shor	00:00	NO	YES
HOST			
Over current	00:00	NO	YES

**CAUTION** *IMPORTANT: For Radio System to work properly, MUST define in the 6.2 SYSTEM SETUP menu – Remote Unit type parameter SN/RF Net.*

In this screen, define Radio Systems alarm activity and notification.

- **ACTIVE:** Defines if alarm is used in making decisions regarding irrigation program (YES / NO)
- **INFORM:** Defines if the system will notify the user of the alarm occurrence (YES / NO)

## 7.8 Radio Sys. Alarm View

RADIO SYS. Alarm view				
Unit	S/N	Comm	Vin state	Card
HOST	0128	OK	-	-
BASE	0117	FAIL	-	-
RTU	0236	OK	-	3.1
RTU	0115.3.4	-	OK	
RTU	0513.4.1	-	FAIL	
RTU	0198	-	WARN	
RTU	0555.3.1	-	LOW	
RTU	----	-	-	
RTU	----	-	-	
RTU	----	-	-	

In this screen, view the current alarm status of the Radio System.

The S/N column is the number of the unit. When an *Open Circuit or Short Circuit* alarm is detected, the system in addition will also present the card number and the input/output number that is problematic.

For Example: RTU - 0555.3.1

The diagram shows three input fields: UNIT #, CARD #, and INPUT/OUTPUT #. A bracket above the first two fields (UNIT # and CARD #) points to the first three digits '0555' of the RTU address. An arrow points from the third digit '3' to the CARD # field. Another arrow points from the last digit '1' to the INPUT/OUTPUT # field.

Exiting and re-entering refreshes the alarm status screen.

# 8 History Menu

The History Menu provides extensive information regarding measurements and processes performed by the GreenField.

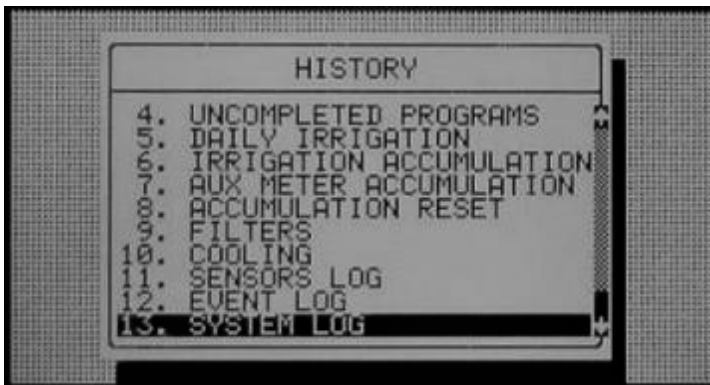
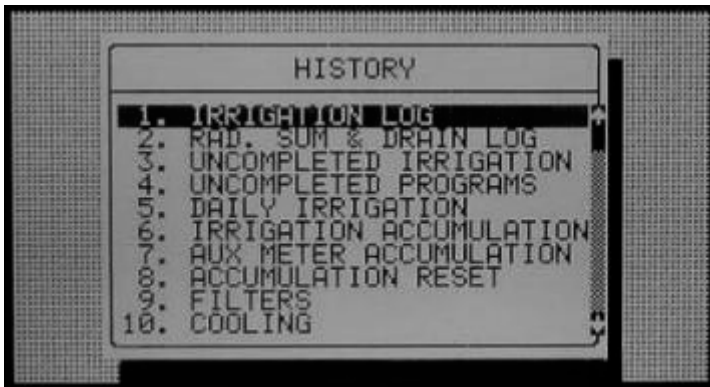

- Irrigation Log, page 95
- RAD. / VPD Sum & Drain Log , page 95
- Uncompleted Irrigation, page 96
- Uncompleted Programs, page 97
- Daily Irrigation, page 97
- Irrigation Accumulation, page 98
- AUX Meter Accumulation, page 98
- Accumulation Reset, page 99
- Filters, page 99
- Cooling, page 100
- Sensors Log, page 100
- Event Log, page 101
- System Log, page 101

## 8.1 Irrigation Log

The Irrigation Log table includes up to 200 rows of the last irrigations data. Each row includes information regarding a specific irrigation.

- To view additional information, use the left/right arrow keys.
- To switch between dosing quantities or time simply press the '+/-' key.

The first screenshot shows the Irrigation Log table with columns: Date, Time, UI, Reason, and Water. The second screenshot shows the same table with columns: Date, Time, UI, Duration, and Flow. The third screenshot shows the table with columns: Date, Time, UI, Chan. 1, and Chan. 2.

- **Date:** Date in which the irrigation started.
- **Time:** Time in which the irrigation started.
- **Valve:** Leading valve; the first valve set for the group of valves
- **Reason:** Specification of the irrigation triggers; time, condition, Rad Sum, etc.
- **Water:** Irrigation quantity (m3 or gallon) or irrigation time.
- **Duration:** Irrigation duration (hh:mm:ss).
- **Flow:** Average flow throughout the irrigation cycle.
- **Chan. #:** Dosing quantities per channel (liter or gallon) or dosing time.
- **EC Low:** Lowest EC value recorded during irrigation.
- **EC Avg.:** Average EC value recorded during irrigation.
- **EC High:** Highest EC value recorded during irrigation.
- **pH Low:** Lowest pH value recorded during irrigation.
- **pH Avg.:** Average pH value recorded during irrigation.
- **pH High:** Highest pH value recorded during irrigation.

**NOTE** Water quantity is measured in m3 or gallons, duration is measured by time, flow is measured in m3/h or gallon/m, dosing quantity is measured in liters or gallons.

## 8.2 RAD. / VPD Sum & Drain Log

The first screenshot shows the RAD. / VPD Sum & Drain Log table with columns: Date, Time, UI, Reason, and Water. The second screenshot shows the same table with columns: Date, Time, UI, Drain %, and Drain. The third screenshot shows the table with columns: Date, Time, UI, Rad Sum, and Interval.

- **Time:** Time irrigation started.

- **Valve:** Leading valve.
- **Reason:** Specification of the irrigation triggers; time, condition, rad sum, etc.
- **Water:** Irrigation quantity (m3 or gallon) or irrigation time.
- **Drain %:** Percentage of drain for relevant irrigation cycle.
- **Drain:** Drain quantity related to relevant irrigation.
- **Rad Sum:** Accumulated radiation sum level when irrigation started.
- **VPD Sum:** Accumulated VPD sum level when irrigation started.
- **Interval:** Time (in minutes) since last irrigation cycle. Refers to the last irrigation of a specific valve.

### 8.3 Uncompleted Irrigation

The Uncompleted Irrigation table provides information of irrigations that were started but could not be completed due to a failure. To understand why an irrigation was not completed it is advisable to cross-reference between this table and the Alarm History table, page 87. The Uncompleted Irrigation table consists of up to 200 lines. Note that if the letter 'C' appears, it refers to a program that was triggered by condition program.

UNCOMPLETED IRRIGATION						
No.	Date	Time hh:mm	Prog No.	Vl. No.	Run No.	Dose Prog
1	20-Dec-06	09:05	1	51+	1	1
2	20-Dec-06	09:25	2	1	1	--

Each line includes information regarding when the irrigation was stopped and added to the uncompleted irrigations table.

- **Date:** Date in which the current line was added to the uncompleted irrigation table.
- **Time:** Time in which the current line was added to the uncompleted irrigation table.
- **Prog. No.:** Program number.
  - **92:** The program that was added to the table was started manually.
  - **93:** The relevant irrigation was added to the uncompleted irrigations table for the second time (or more) consecutively.
- **Vl. No.:** Indicates the associated valve. If a group of valves that is configured to irrigate together is stopped, only the first valve is written but a '+' sign is added next to it to indicate that more valves are associated. The GreenField will attempt to complete the irrigations from the current day (until end day time) upon manual or automatic alarm reset.
  - The valve column of irrigations that are to be completed will be highlighted.
  - The valve column of irrigations that are currently being completed will blink.
- **Run No.:** Indicates the associated run time program.
- **Dose Prog.:** Indicates the associated dosing program.

- Prog. Qty.: Planned quantity according to the run time program.
- Left Qty.: Uncompleted quantity.

To manually stop an uncompleted irrigation, go to the Start/Stop Valve table, page 84 because the activation is according to single valves.

## 8.4 Uncompleted Programs

The Uncompleted Programs table provides information on programs that could not be completed. It is important to understand the difference between this table and the Uncompleted Irrigations table; this table consists only of irrigation cycles that haven't been started and could not be completed during the current day. This can happen due to wrong system setup (more tasks than could be completed), or because the system was not active for a long period of time, for example due to a power failure, and could not complete its tasks.

UNCOMPLETED PROGRAMS						
No.	Date	Time hh:mm	Prog No.	Start Time	Prog Cyc.	Left Cyc.
4	9/Aug	20:00	10	19:00	1	1
5	9/Aug	21:00	10	20:00	1	1
6	10/Aug	04:00	1	13:00	2	2
7	10/Aug	05:00	1	04:00	2	2
8	10/Aug	06:00	10	21:00	1	1
9	10/Aug	07:00	1	05:00	2	2
10	10/Aug	09:00	1	07:00	2	2
11	10/Aug	11:00	1	09:00	2	2
12	10/Aug	13:00	1	11:00	2	2
13	10/Aug	14:00	10	06:00	1	1

The uncompleted program table consists of 200 lines.

## 8.5 Daily Irrigation

This table allows you to view history of irrigation quantities or time per valve.

DAILY IRRIGATION

---

How Many Days Ago?   ▶   1 Day Ago

Press *ENTER* to open the selection list, move with the arrow keys to the relevant day and confirm your choice by pressing *ENTER*.

For example, 1 day ago means you would like to view yesterday's history, and Today means you would like to view the accumulated history since the last End Day.

DATE : 20-Dec-06

DAILY IRRIGATION

Valve	Water	Drain %	Dra. Q.
213	0.0000	100	0.0000
214	0.0000	100	0.0000
215	70.8000	11	0.0000
216	1.4000	3.0	0.0000
217	10.1000	3.4	0.0000
218	19.2000	4.5	0.0000
219	0.0000	100	0.0000
220	0.0000	100	0.0000
221	0.0000	100	0.0000

Press +/- to Toggle Quantity/Time

DATE : 20-Dec-06

DAILY IRRIGATION

Valve	Chan. 1	Chan. 2	Chan. 3
213	0.00	0.00	0.00
214	0.00	0.00	0.00
215	211.36	211.37	211.37
216	3.94	3.94	3.94
217	30.82	30.82	30.82
218	19.97	19.97	19.97
219	26.01	26.01	26.01
220	0.00	0.00	0.00
221	0.00	0.00	0.00

Press +/- to Toggle Quantity/Time

The relevant date you are currently viewing will be displayed at the top of the screen.

The Daily Irrigation table contains all water (m3 or gallon) and dosing (liter or gallon). To toggle the view between quantities and time, press the '+/-' key.

## 8.6 Irrigation Accumulation

The Irrigation Accumulation table allows you to accumulate water and dosing quantities for the required periods. The accumulation of each valve can be reset separately in the Accumulation Reset table.

DATE : 21-Dec-06

IRRIGATION ACCUMULATION

Valve	Date	Water	Chan. 1
214	20-Dec-06	0.000	0.00
215	20-Dec-06	70.800	211.36
216	20-Dec-06	1.400	3.94
217	20-Dec-06	10.100	30.82
218	20-Dec-06	19.200	19.97
219	20-Dec-06	16.800	26.01
220	20-Dec-06	0.000	0.00
221	20-Dec-06	0.000	0.00
222	20-Dec-06	0.000	0.00

Press +/- to Toggle Quantity/Time

DATE : 21-Dec-06

IRRIGATION ACCUMULATION

Valve	Chan. 1	Chan. 2	Chan. 3
214	0.00	0.00	0.00
215	211.36	211.37	211.37
216	3.94	3.94	3.94
217	30.82	30.82	30.82
218	19.97	19.97	19.97
219	26.01	26.01	26.01
220	0.00	0.00	0.00
221	0.00	0.00	0.00
222	0.00	0.00	0.00

Press +/- to Toggle Quantity/Time

To toggle the view between quantities and time, press the '+/-' key. Water quantity is measured in cubic meter or gallons; dosing quantity is measured in liters or gallons.

## 8.7 AUX Meter Accumulation

The Auxiliary Meter Accumulation table allows you to accumulate quantities from meters that do not have designated software, for example, in order to measure the drain water quantity or to measure the cooling system's consumption.

*NOTE These water meters are accumulators only and are not a part of the irrigation control.*

AUX METER ACCUMULATION

Meter	Quantity	Date
0-10-04-04-1	4.600	20-Dec-06
0-10-04-04-2	4.500	20-Dec-06
0-10-04-04-3	2.200	20-Dec-06
0-10-04-04-4	2.500	20-Dec-06
0-10-04-04-5	4.450	20-Dec-06
0-10-04-04-6	6.600	20-Dec-06
0-10-04-04-7	4.700	20-Dec-06
0-10-04-04-8	4.200	20-Dec-06



The quantities displayed are in liters (gallons) up to 9999.999. To reset an auxiliary meter refer to the Accumulation Reset table below.

## 8.8 Accumulation Reset

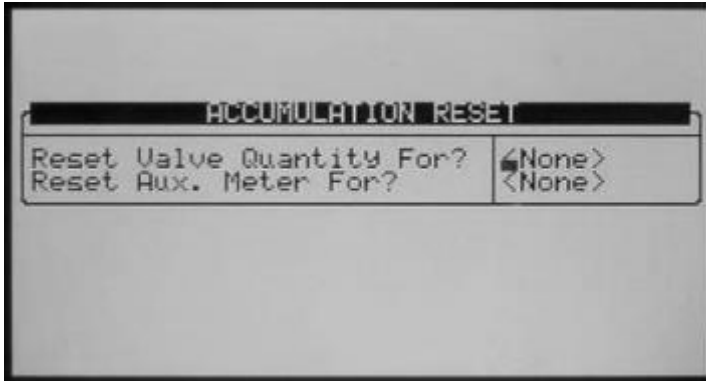

To reset accumulation of an individual valve or of all valves press the *ENTER* key, choose the relevant option using the arrow keys and confirm by pressing the *ENTER* key.

*NOTE* When resetting a valve (or all valves) its history will be erased from the following tables:

- Daily Irrigation
- Irrigation Accumulation

To reset an individual auxiliary meter or all auxiliary meters press *ENTER*, choose the relevant option using the arrow keys, and confirm by pressing *ENTER*.

*NOTE* When resetting an Aux meter (or all Aux meters) its history will be erased from the Aux Meter Accumulation table.

## 8.9 Filters

The Filters History Table provides daily information of the number and cause of flushing.

The screenshot shows a terminal window with the title "FILTERS". Below the title, there is a table with four columns: "Date", "Delta P.", "Time", and "Manual". The table contains three rows of data.

Date	Delta P.	Time	Manual
10/Aug	0	44	0
9/Aug	0	0	0
8/Aug	0	0	0

## 8.10 Cooling

Use this screen to view cooling history or time per valve.

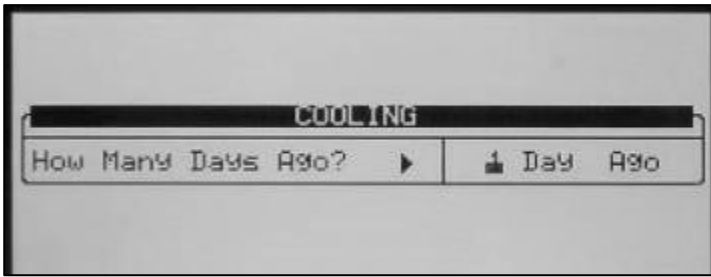

Press **ENTER** to open the selection list, move with the arrow keys to the relevant day and confirm your selection by pressing **ENTER**.

For example, 1 day ago means you would like to view yesterday's history, and Today means you would like to view the accumulated history since the last End Day.

The screenshot shows a terminal window with the title "COOLING" and a date "DATE : 26-Dec-06". Below the title is a table with the following columns: "Prog. No.", "From hh:mm", "To hh:mm", and "Cycles".

Prog. No.	From hh:mm	To hh:mm	Cycles
1	13:10	18:14	60
	13:13	18:14	9
	---:--	---:--	-----
	---:--	---:--	-----
	---:--	---:--	-----
	---:--	---:--	-----
	---:--	---:--	-----
	---:--	---:--	-----

## 8.11 Sensors Log

The Sensors Log Table includes history of average measurements of logged sensors. To define which sensors should be logged and the averaging interval refer to table 6.2.

The screenshot shows a terminal window with the title "SENSORS LOG". Below the title is a table with the following columns: "Date", "Time", "Avg. Temp", "Temp-1", and "Temp-2".

Date	Time	Avg. Temp	Temp-1	Temp-2
10/Aug	16:28	22.7	22.7	-----
10/Aug	16:27	22.7	22.7	-----
10/Aug	16:26	22.7	22.7	-----
10/Aug	16:25	22.7	22.7	-----
10/Aug	16:24	22.7	22.7	-----
10/Aug	16:23	22.7	22.7	-----
10/Aug	16:22	22.7	22.7	-----
10/Aug	16:21	22.7	22.7	-----
10/Aug	16:20	22.7	22.7	-----
10/Aug	16:19	22.7	22.7	-----

The Sensors Log Table contains up to 10,000 data fields. Date and time are two fields per line and every sensor is an additional field. For example: logging of two sensors uses four data fields; two for time and date and one for each sensor. In this case, the table will consist of a maximum of 2,500 lines.

## 8.12 Event Log

The table provides information of all the processes performed by the GreenField including their time and date.

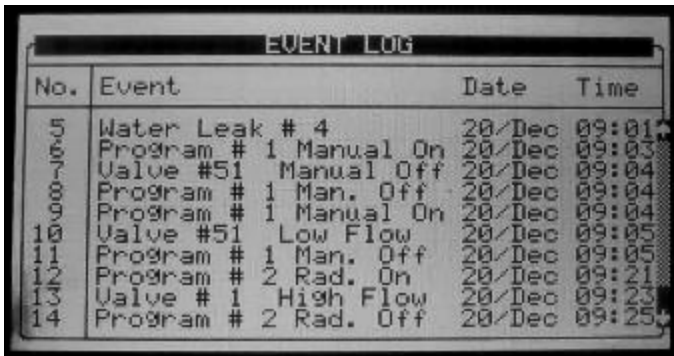

No.	Event	Date	Time
5	Water Leak # 4	20/Dec	09:01
6	Program # 1 Manual On	20/Dec	09:03
7	Valve #51 Manual Off	20/Dec	09:04
8	Program # 1 Man. Off	20/Dec	09:04
9	Program # 1 Manual On	20/Dec	09:04
10	Valve #51 Low Flow	20/Dec	09:05
11	Program # 1 Man. Off	20/Dec	09:05
12	Program # 2 Rad. On	20/Dec	09:21
13	Valve # 1 High Flow	20/Dec	09:23
14	Program # 2 Rad. Off	20/Dec	09:25

The table consists of the last 999 events.

## 8.13 System Log

This table provides information of all the system changes. Examples of system changes are changes of triggered by the controller, the PC communication, a power off, etc.

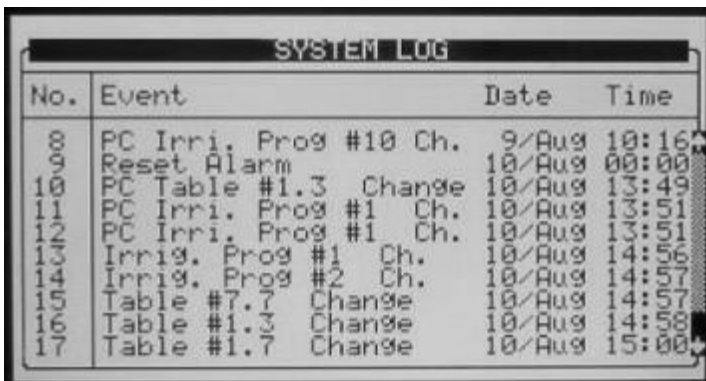

No.	Event	Date	Time
8	PC Irrig. Prog #10 Ch.	9/Aug	10:16
9	Reset Alarm	10/Aug	00:00
10	PC Table #1.3 Change	10/Aug	13:49
11	PC Irrig. Prog #1 Ch.	10/Aug	13:51
12	PC Irrig. Prog #1 Ch.	10/Aug	13:51
13	Irrig. Prog #1 Ch.	10/Aug	14:56
14	Irrig. Prog #2 Ch.	10/Aug	14:57
15	Table #7.7 Change	10/Aug	14:57
16	Table #1.3 Change	10/Aug	14:58
17	Table #1.7 Change	10/Aug	15:00

The table displays of the last 999 events.

# 9 Test Menu

TEST	
1.	RELAYS
2.	DIGITAL INPUT
3.	ANALOG INPUT
4.	TEMPERATURE
5.	HUMIDITY
6.	ANALOG SENSOR
7.	HARDWARE CHECKLIST
8.	ANALOG OUTPUT

The Test menu provides a quick way of verifying functionality.

- Relays, page 102
- Digital Input, page 103
- Analog Input, page 104
- Temperature, page 105
- Humidity, page 105
- Hardware Check List, page 105
- Analog Output Test, page 106

## 9.1 Relays

The Relays Test screen allows you to check the current output status and verify proper operation.

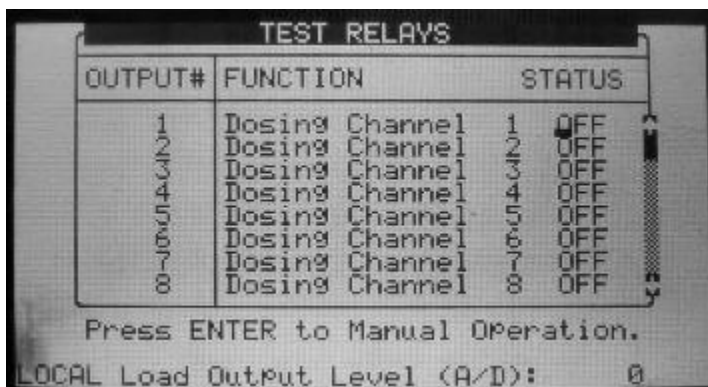

The screenshot shows a terminal window titled "TEST RELAYS". It contains a table with three columns: "OUTPUT#", "FUNCTION", and "STATUS". The table lists 8 dosing channels, all of which are currently "OFF". Below the table, there is a prompt "Press ENTER to Manual Operation." and a line for "LOCAL Load Output Level (A/D):" with the value "0".

OUTPUT#	FUNCTION	STATUS
1	Dosing Channel 1	OFF
2	Dosing Channel 2	OFF
3	Dosing Channel 3	OFF
4	Dosing Channel 4	OFF
5	Dosing Channel 5	OFF
6	Dosing Channel 6	OFF
7	Dosing Channel 7	OFF
8	Dosing Channel 8	OFF

Press ENTER to Manual Operation.

LOCAL Load Output Level (A/D): 0

TEST RELAYS			
OUTPUT#	FUNCTION		STATUS
126	None	0	OFF
127	Same As Relay	11	OFF
128	Valve	54	OFF
129	Valve	115	OFF
130	Valve	116	OFF
131	Valve	117	OFF
132	None	0	OFF
133	None	0	OFF

Press ENTER to Manual Operation.

EXT1 Load Output Level (A/D): 0

TEST RELAYS			
OUTPUT#	FUNCTION		STATUS
249	None	0	OFF
250	None	0	OFF
251	None	0	OFF
252	None	0	OFF
253	None	0	OFF
254	None	0	OFF
255	Same As Relay	13	OFF
256	Valve	255	OFF

Press ENTER to Manual Operation.

EXT3 Load Output Level (A/D): 0

The setting switches automatically between ON and Off depending on device actual status.

To manually test relay functionality, move the cursor to required device using the arrow keys and press ENTER; the device is turned on and the setting will show Man.

Press ENTER again to return to automatic operation.

- OFF: The output is not active.
- ON: The output is automatically turned on by the relevant program.
- Man: Manual operation of the output. The manual operation resets after 30 minutes of being idle, to prevent you from forgetting to set it back to automatic operation.
- Load Output Level: Output level in A/D values. The value is constantly updated in accordance to relay operation and output level change. This value is used to calculate the A/D threshold value to be considered as a short circuit.

## 9.2 Digital Input

The Digital Input test screen allows you to verify the proper operation of digital inputs and sensors. Digital inputs are defined as meters (water meters, dosing meters, etc.) that count the number of closed contacts from 0 to 255 and automatically restart back from 0. Other digital inputs (Dry contact, Ext. Pause, etc.) show either 0 when the contact is open or 1 when the contact is closed.

Note that the card number is set according to its jumpers regardless to its location (local or extension box).

DIGITAL INPUT				
Channel	Card No.1	Card No.2	Card No.3	Card No.4
1	59	28	37	39
2	00	00	00	00
3	00	00	00	00
4	00	00	00	00
5	00	00	00	00
6	00	00	00	00
7	00	00	00	00
8	00	00	00	00
9	00	00	00	00
10	00	00	00	00
11	00	00	00	00
12	00	00	00	00
13	00	00	00	00
14	00	00	00	00
15	00	00	00	00
16	00	00	00	00
17	00	00	00	00
18	00	00	00	00
19	00	00	00	00
20	00	00	00	00
21	00	00	00	00
22	00	00	00	00
23	00	00	00	00
24	00	00	00	00
25	00	00	00	00
26	00	00	00	00
27	00	00	00	00
28	00	00	00	00
29	00	00	00	00
30	00	00	00	00
31	00	00	00	00
32	00	00	00	00
33	00	00	00	00
34	00	00	00	00
35	00	00	00	00
36	00	00	00	00
37	00	00	00	00
38	00	00	00	00
39	00	00	00	00
40	00	00	00	00
41	00	00	00	00
42	00	00	00	00
43	00	00	00	00
44	00	00	00	00
45	00	00	00	00
46	00	00	00	00
47	00	00	00	00
48	00	00	00	00
49	00	00	00	00
50	00	00	00	00
51	00	00	00	00
52	00	00	00	00
53	00	00	00	00
54	00	00	00	00
55	00	00	00	00
56	00	00	00	00
57	00	00	00	00
58	00	00	00	00
59	00	00	00	00
60	00	00	00	00
61	00	00	00	00
62	00	00	00	00
63	00	00	00	00
64	00	00	00	00
65	00	00	00	00
66	00	00	00	00
67	00	00	00	00
68	00	00	00	00
69	00	00	00	00
70	00	00	00	00
71	00	00	00	00
72	00	00	00	00
73	00	00	00	00
74	00	00	00	00
75	00	00	00	00
76	00	00	00	00
77	00	00	00	00
78	00	00	00	00
79	00	00	00	00
80	00	00	00	00
81	00	00	00	00
82	00	00	00	00
83	00	00	00	00
84	00	00	00	00
85	00	00	00	00
86	00	00	00	00
87	00	00	00	00
88	00	00	00	00
89	00	00	00	00
90	00	00	00	00
91	00	00	00	00
92	00	00	00	00
93	00	00	00	00
94	00	00	00	00
95	00	00	00	00
96	00	00	00	00
97	00	00	00	00
98	00	00	00	00
99	00	00	00	00
100	00	00	00	00
101	00	00	00	00
102	00	00	00	00
103	00	00	00	00
104	00	00	00	00
105	00	00	00	00
106	00	00	00	00
107	00	00	00	00
108	00	00	00	00
109	00	00	00	00
110	00	00	00	00
111	00	00	00	00
112	00	00	00	00
113	00	00	00	00
114	00	00	00	00
115	00	00	00	00
116	00	00	00	00
117	00	00	00	00
118	00	00	00	00
119	00	00	00	00
120	00	00	00	00
121	00	00	00	00
122	00	00	00	00
123	00	00	00	00

### 9.3 Analog Input

Analog inputs will show values from 0 to 1023.

ANALOG INPUT		
Channel	Card No.1	Card No.2
1	439	791
2	216	846
3	208	200
4	208	200
5	208	200
6	208	200
7	208	200
8	208	200
9	208	200
10	208	200
11	208	200
12	208	200
13	208	200
14	208	200
15	208	200
16	208	200
17	208	200
18	208	200
19	208	200
20	208	200
21	208	200
22	208	200
23	208	200
24	208	200
25	208	200
26	208	200
27	208	200
28	208	200
29	208	200
30	208	200
31	208	200
32	208	200
33	208	200
34	208	200
35	208	200
36	208	200
37	208	200
38	208	200
39	208	200
40	208	200
41	208	200
42	208	200
43	208	200
44	208	200
45	208	200
46	208	200
47	208	200
48	208	200
49	208	200
50	208	200
51	208	200
52	208	200
53	208	200
54	208	200
55	208	200
56	208	200
57	208	200
58	208	200
59	208	200
60	208	200
61	208	200
62	208	200
63	208	200
64	208	200
65	208	200
66	208	200
67	208	200
68	208	200
69	208	200
70	208	200
71	208	200
72	208	200
73	208	200
74	208	200
75	208	200
76	208	200
77	208	200
78	208	200
79	208	200
80	208	200
81	208	200
82	208	200
83	208	200
84	208	200
85	208	200
86	208	200
87	208	200
88	208	200
89	208	200
90	208	200
91	208	200
92	208	200
93	208	200
94	208	200
95	208	200
96	208	200
97	208	200
98	208	200
99	208	200
100	208	200
101	208	200
102	208	200
103	208	200
104	208	200
105	208	200
106	208	200
107	208	200
108	208	200
109	208	200
110	208	200
111	208	200
112	208	200
113	208	200
114	208	200
115	208	200
116	208	200
117	208	200
118	208	200
119	208	200
120	208	200
121	208	200
122	208	200
123	208	200

Sensor type	Description
pH sensor	pH = 0 - A/D = 205
	pH = 7.0 - A/D = 615
	pH = 14.0 - A/D = 1023
EC sensor	EC = 0 - A/D = 205
	EC = 2.0 - A/D = 370
	EC = 10.0 - A/D = 1024
Humidity sensor	RH% = 0 - A/D = 0
	RH% = 50 - A/D = 308
	RH% = 100 - A/D = 620
Temp sensor	T°C = 0 - A/D = 768
	T°C = 25 - A/D = 489
	T°C = 50 - A/D = 250

## 9.4 Temperature

This table shows the current temperature sensor readings in degrees (Celsius or Fahrenheit depending on the setup in the screen).

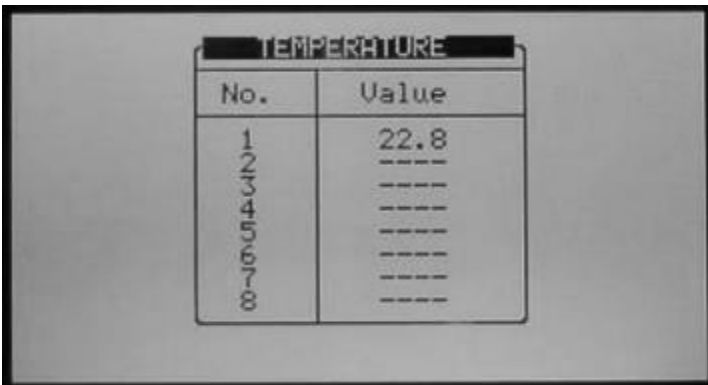

TEMPERATURE	
No.	Value
1	22.8
---	---
---	---
---	---
---	---
---	---
---	---

## 9.5 Humidity

This table shows the current humidity sensor readings in percentage relative humidity.



HUMIDITY	
No.	Value
1	55.3
---	---
---	---
---	---
---	---
---	---
---	---

## 9.6 Hardware Check List

The Hardware Checklist displays which and how many output and input cards are connected and where they are connected; local, or in one of the extension boxes. Position of cards connected locally will appear on the bottom table.

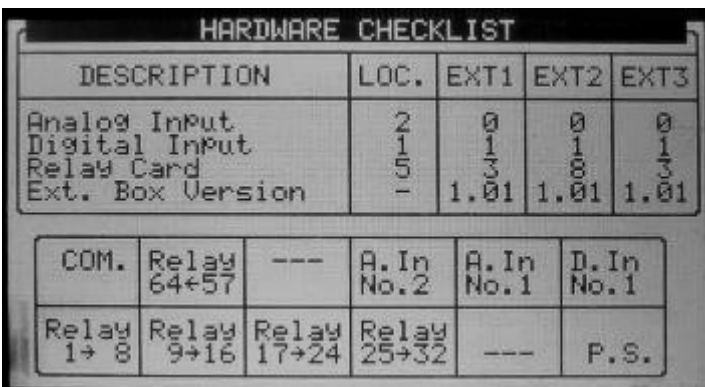

HARDWARE CHECKLIST				
DESCRIPTION	LOC.	EXT1	EXT2	EXT3
Analog Input	2	0	0	0
Digital Input	1	1	1	1
Relay Card	5	3	8	3
Ext. Box Version	-	1.01	1.01	1.01

COM.	Relay 64+57	---	A. In No.2	A. In No.1	D. In No.1
Relay 1+8	Relay 9+16	Relay 17+24	Relay 25+32	---	P.S.

To update the Hardware Checklist, disconnect the GreenField from the power supply or perform a cold start procedure.

The bottom row shows 24 VAC output cards, dry contact output cards and power supply. The upper row shows dry contact output cards, analog and digital input cards, and communication card.

*NOTE Notice that in the large boxes this table should be turned left to see actual cards position. For example the communication card (COM.) will actually be on the bottom left side of the box.*

## 9.7 Analog Output Test

The Analog Output test screen enables testing the valves' opening, both while in operation or off-line. The test shows:

- The amount of current going to the valve
- Test results

From these data points, the user can troubleshoot a faulty valve.

ANALOG OUTPUT				
N#	Status	Open%	Meas	Fail
1	AUTO	70	54.00	ON
2	AUTO	70	4.00	ON
3	MAN	50	10.50	OFF
4	MAN	70	14.00	OFF
5	AUTO	60	12.00	OFF
6	AUTO	60	12.00	OFF
7	AUTO	60	12.00	OFF
8	AUTO	60	12.00	OFF

- Define and map the analog output card(s) in Analog Output, page 142.
- Configure dosing in Dosing Configuration, page 131.

To test the analog output valves:

- Under Status, select one of the following:
  - **AUTO:** GreenField tests the valve opening percentage. Use this option while the controller is operating.
  - **MAN:** The user defines the valves' opening percentage.
- The screen displays the test results:
  - **Meas:** This field displays the amperage used to open the valve, from 4 - 20 mA. 4 corresponds to closed completely (0%) and 20 corresponds to open completely (100%).
  - **Fail:**
    - **ON:** The valve is not operating properly
    - **OFF:** The valve is operating properly
- Troubleshooting:
  - If the test fails and there is high amperage, the card is installed improperly (Number 1 in the above figure).
  - If the test fails and there is no amperage (4.00), there is a short circuit (Number 2 in the above figure).



# 10 Setup

The Setup Menu provides clock, calibration; plug storage/retrieval and language settings.



- Time & Date, page 108
- System Setup, page 108
- Temperature Calibration, page 111
- Humidity Calibration, page 112
- EC/pH Calibration, page 112
- Pressure Calibration, page 115
- Weather Station Calibration, page 115
- Sensors Logging, page 115
- Write to Data Plug, page 116
- Read from Data Plug, page 117

## 10.1 Time & Date

The Time & Date screen allows you to set the current time and date as well as the end of the crop daytime.

To adjust the time and date, place the cursor on the setting you wish to modify, change the numbers using the keypad and press ENTER to save your changes.

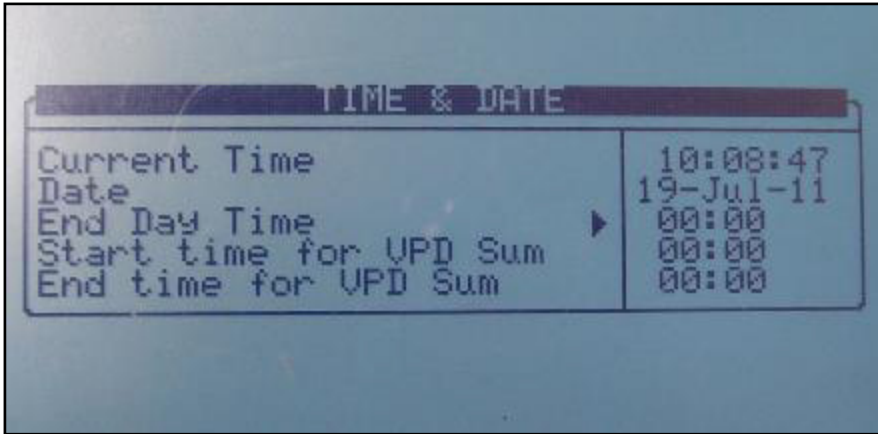

- **End Day Time:** Select the start time of a new day 00:00 to 23:00. At End Day time:
  - All the alarms are reset.
  - All the uncompleted irrigations are reset. Irrigation cycles that haven't been completed will move to the Uncompleted Programs table, page 97.
  - All the valves that are registered in the uncompleted programs table and did not complete the irrigation are switched from Wait position to Do Not Continue (Move to history).
  - Cycle days in the PROGRAM table are moved one day ahead.
  - The daily % change is zeroed (the constant % change stays the same).
  - ◆ Currently active cycle will continue with its current settings until completed.
- **Start/End time for VPD Sum** – Set the time frame for the VPD Sum counter.
  - Only during this time frame will the VPD be summed
  - At End time for VPD Sum, the counter is reset

## 10.2 System Setup

The System Setup screen includes all general system settings.

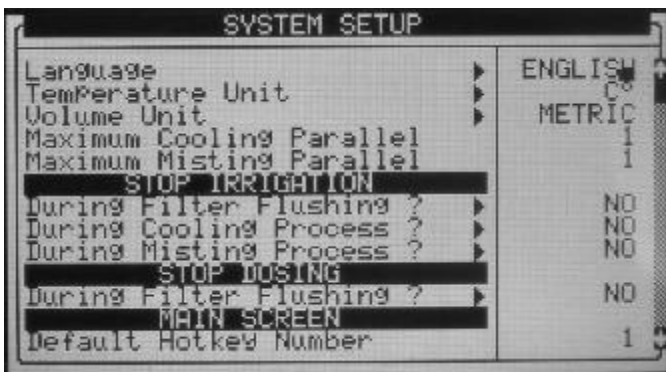

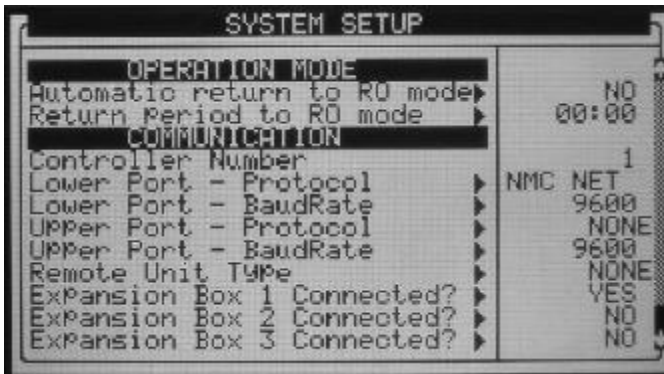

- Language: Choose controller language.
- Temperature Unit: Celsius or Fahrenheit.
- Volume Unit: Metric (m3 & Liter) or Gallon. These units also influence the pressure measurement units; when choosing metric pressure, measurement will be in bar, when choosing gallon pressure, measurement will be in PSI.
- Maximum Cooling Parallel: Define the maximum number of cooling programs to be operated simultaneously. The maximal possible number is 8.

*NOTE This number refers to the number of cooling programs that will be operated in parallel; valves from the same cooling program will always be operated sequentially.*

- Maximum Misting Parallel: Define the maximum number of misting valves to be operated simultaneously. The maximal possible number is 40.

### STOP IRRIGATION

- During Filter Flushing: Define whether irrigation should be stopped during filter flushing.
- During Cooling Process: Define whether irrigation should be stopped during cooling.
- During Misting Process: Define whether irrigation should be stopped during misting.

### STOP DOSING

- During Filter Flushing: Define whether dosing should be stopped during filter flushing.

### MAIN SCREEN

- Default Hot Key Number: Define the required default hot key number. When the system is idle for a few minutes the controller will automatically switch to the default hot key (hot-screen)

## HISTORY

- **History Resolution:** Set the history collection rate of the sensors. For example if set to 15 minutes, the controller will collect data from the defined sensors every 15 minutes (see 10.8 Sensors Logging for configuring which sensors / data is collected).

## WEATHER STATION

- **Controller function:** Define whether this controller is connected to a weather station directly or through the network.
  - **Local:** A weather station is connected to this controller; its data is used locally only and should not be passed or received through the network.
  - **Slave:** This controller receives weather station data through the network; the data is collected by another GreenField, which is connected directly to a weather station defined as Master. Sensors connected directly to a slave controller will be used by it and will have a higher priority than those transmitted by the master.
  - **Master:** A weather station is connected to this controller and its data should be transmitted through the network to other controllers. There can be only one master controller of any type in each network.

## OPERATION MODE

- **Automatic return to RO mode:** Define if the controller will return automatically back to the Read Only mode after a certain period of time.
- **Return Period to Read Only mode:** Set the amount of time for the controller to return automatically to the Read Only mode (mm:ss).  
*This parameter is only relevant if the Automatic return to RO mode parameter is defined as YES*

## COMMUNICATION

- **Controller Number:** Select the controller number for communication. The controller number in the controller and in the PC should match in order for the communication to work. Each controller in the network must have a unique number.
- **Lower Port – Protocol – Communicate with:**
  - Green Net: Local Network
  - GSM RCLP – GSM Modem
- **Lower Port – Baudrate (PC Communication Network):** Select the lower port's baud rate for communication. The baud rate in the controller and in the PC must match; otherwise, the communication cannot operate properly.

*NOTE See GreenField Part 2 > Appendix 4 – Network connection & PC software for additional information regarding controller number and baud rate.*

- **Upper Port – Protocol – SN/RF Net.** Square One Single Net protocol should be selected in order to define the Remote Unit Type.
- **Upper Port – Baudrate (Extension Box Network):** Select the upper port's baud rate for communication. The baud rate in the controller and in the extension boxes must match; otherwise, the communication cannot operate properly.

*NOTE GreenField Part 2 > Table 2 – Baud rate values. This table provides explanations regarding how to set the Baud rates in the extension boxes.*

- **Remote unit type:** Select the type of remote units connected to the GreenField:
  - **NONE:** No remote units are connected to the GreenField.
  - **SN/RF Net:** SingleNet or RadioNet remote units are connected to the GreenField.
  - **SA RADIO:** Radio remote units are connected to the GreenField.

*NOTE When choosing SingleNet or Radio relevant parameters will appear in the controller.*

*NOTE Only one type on remote units (SingleNet or Radio) can be connected to a specific controller.*

- **Extension Box # Connected:** Specify whether the relevant extension box is connected or not. The GreenField will “search” for the relevant extension box and will update the Hardware Check List and all other relevant settings accordingly. If the GreenField doesn’t recognize the extension box an alarm “Ext. Box # Com fail” will be generated, in case communication is reestablished the alarm will be automatically reset.

## WATER SOURCE

- **Flow Rate – Start From:** Select whether the flow rate calculation in an irrigation will begin either with the value Zero (which means that the flow rate will increase according to pulses received), or a Nominal value calculated using all the active valves in the irrigation. The calculation method is important primarily for dosing and EC/pH control. When using a controller which operates with relatively slow pulses, it is recommended to choose the Nominal flow rate option due to inaccurate flow calculation in the first stage of the irrigation. When operating with slow pulses and starting with a Zero value, it will take a long time for the controller to reach its' actual flow rate value. When operating by fast pulses, choose either Zero or Nominal.
- **Calculated Flow Delay:** This parameter is relevant only when Nominal is being selected in the previous parameter. This parameter defines the time the controller uses its' nominal flow rate value before switching to the calculated one. In this period LOW FLOW and HIGH FLOW alarms will not be detected.

### 10.3 Temperature Calibration

This menu enables calibrating temperature sensors. Use the Left/right arrow keys to increase/decrease the values. Munters recommends calibrating the temperature sensors using a reference sensor.

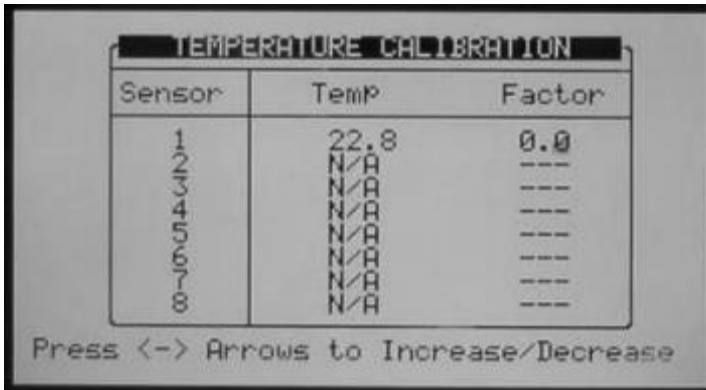

## 10.4 Humidity Calibration

This menu enables calibrating humidity sensors. Use the Left/right arrow keys to increase/decrease the values Munters recommends calibrating the humidity sensors using a reference sensor.

## 10.5 EC/pH Calibration

Calibration of EC & PH is comprised of two steps:

- Calibration of the EC/pH Monitor Transmitter, page 112
- EC/pH Transmitter Monitor & GreenField Correlation, page 114

### 10.5.1 CALIBRATION OF THE EC/PH MONITOR TRANSMITTER

Use the following instructions when using Munters EC/pH transmitters. When using other types of transmitters use calibration guidelines supplied by the manufacturer and jump to EC/pH Transmitter Monitor & GreenField Correlation.



EC & PH main screen

#### 10.5.1.1 EC Calibration

- Auto Set EC (EC factory set)
- EC Soft Calibration

#### 10.5.1.1.1 Auto Set EC (EC factory set)

The Auto set procedure initializes all the previous corrections and sets the calibration according to the factory settings. Perform Auto set on the first run and when you replace an EC Electrode with a new one.

1. Press the MENU button and wait for the Service prompt to appear.
2. Press SELECT button several times until *AUTOSET EC* prompt is displayed and then press ENTER. The message OK is displayed for a while and then the display reverts back to normal.

*NOTE Always perform EC Soft Calibration after the Auto set EC (EC factor set)*

#### 10.5.1.1.2 EC Soft Calibration

1. Press the MENU button and wait for the Service prompt to appear.
2. Press SELECT button several times until the *CALIB(rate) EC* prompt is displayed and then press ENTER.
3. Use the SELECT button to choose *EC 1.4* or *EC 5*, according to your water value and the buffers you have, press ENTER to confirm.
4. Insert the probe into the appropriate buffer, wait for approximately 10 seconds, and press ENTER. You will be asked to wait for a few seconds, while the unit performs the value correction.
5. The Gain point is now set and *EC 0.0* will be displayed. Hold the EC probe out in the open air and wipe it gently with a napkin or a tissue, then press ENTER.
6. If the calibration process is completed successfully, *EC Calibration OK* is displayed. If it fails, *EC CALIBRATION FAIL* is displayed.

### 10.5.1.2 pH Calibration

- Auto Set pH (pH Factory set)
- pH Soft Calibration

#### 10.5.1.2.1 Auto Set pH (pH Factory set)

The Auto set procedure initializes all the previous corrections and sets the calibration according to the factory settings.

Perform Auto set on the first run and when you replace a pH electrode with a new one.

1. Press MENU and wait for the Service prompt to appear.
2. Press SELECT several times until *AUTOSET pH* is displayed and press ENTER. The message OK is displayed for a while and then the display reverts back to normal.

*NOTE Always perform pH Soft Calibration after the Auto set pH (pH factory set)*

#### 10.5.1.2.2 pH Soft Calibration

1. Remove the pH probe and clean it by directing a stream of water towards its membrane. Do not wipe or dry the membrane.
2. Press the MENU button and wait for the Service prompt to appear.
3. Press SELECT button several times until the *CALIB(rate) pH* prompt is displayed and then press ENTER.

4. When *pH 7.0* is displayed, immerse the probe in the pH 7.0 buffer, wait for approximately 10 seconds and press *ENTER*. You will be asked to wait for a few seconds, while the unit performs the value correction. The Gain point is now set.
5. When *pH 4.0* is displayed, immerse the probe in the pH 4.0 buffer, wait for approximately 30 seconds and press *ENTER*. You will be asked to wait for a few seconds, while the unit performs the value correction. The Offset point is now set.
6. If the calibration process is completed successfully, *pH Calibration OK* will be displayed. If it fails, *LOQUID IS POOR* is displayed.

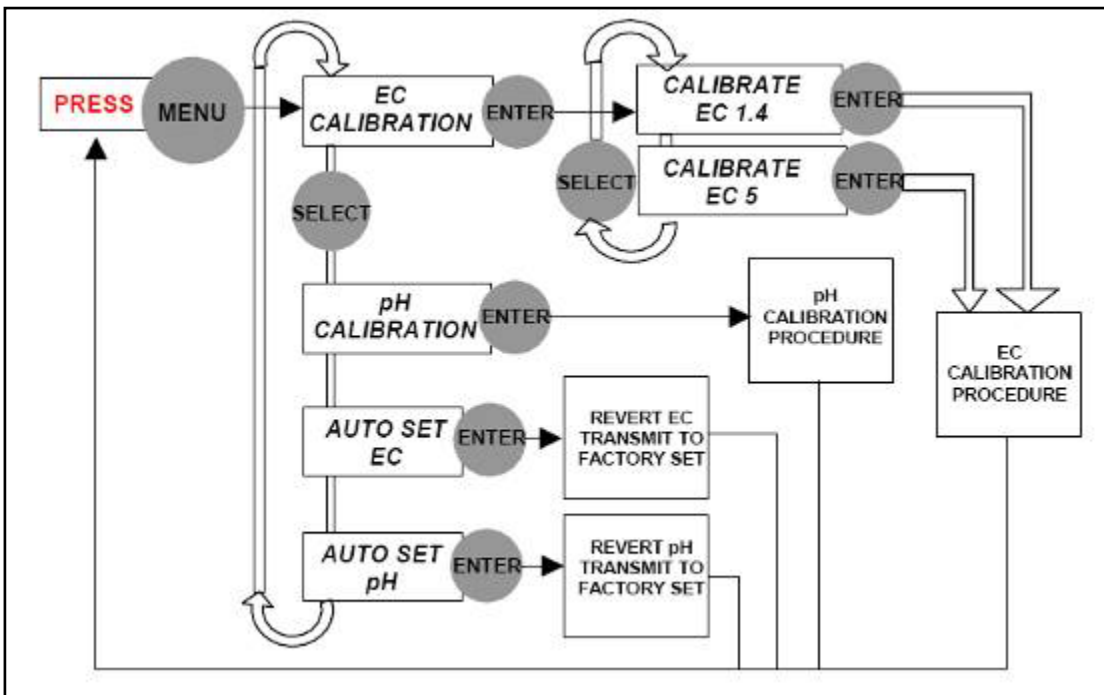

Menu Navigation Schema

## 10.5.2 EC/PH TRANSMITTER MONITOR & GREENFIELD CORRELATION

EC/PH CALIBRATION		
Sensor	Value	Factor
EC 1	1.71	0.06
PH 1	2.36	0.07
EC 2	<NONE>	---
PH 2	<NONE>	---
EC P	<NONE>	---

Press <-> Arrows to Increase/Decrease

Place the cursor on the relevant factor and use the left/right arrow keys to increase/decrease the factor until the values displayed by the GreenField are equal to the values indicated on the EC/pH transmitter screen.

To ensure the measured values are stable it is recommended to immerse the sensor in calibration fluid when doing this process.

Under normal operation conditions the correlation process should be done only when there are system changes, for example when changing EC/pH sensors, nevertheless it is



recommended to verify that the readings of the EC/pH transmitter and of the GreenField are equal every time EC/pH calibration is performed, and adjust if required.

## 10.6 Pressure Calibration

This screen is used to calibrate inlet and outlet pressure sensors. Calibration of the pressure sensors is usually done using reference pressure sensors connected in the vicinity of the electronic pressure sensors.

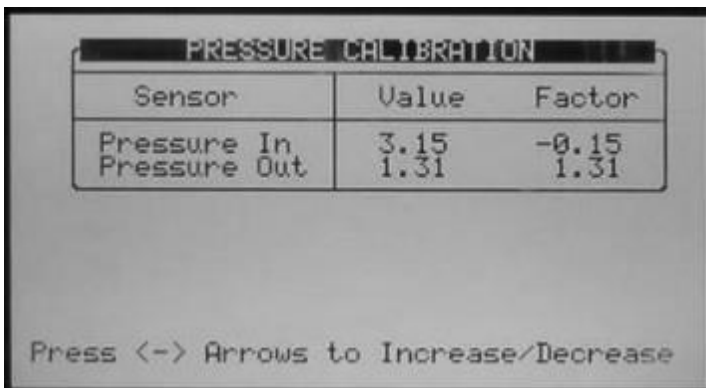

Use the left/right arrow keys to increase/decrease values until the values displayed by the GreenField are equal to the values indicated on the reference pressure sensor.

## 10.7 Weather Station Calibration

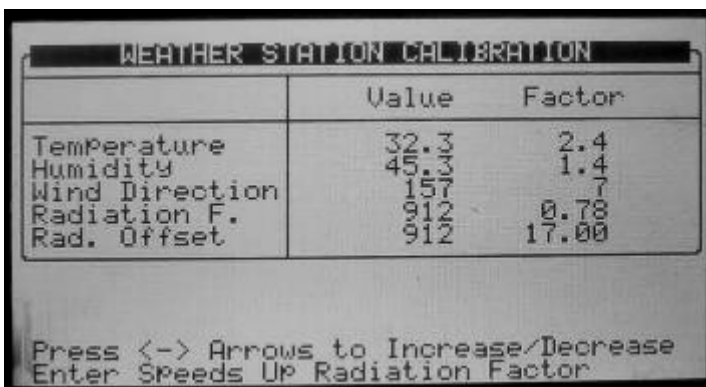

Use the left/right arrow keys to increase/decrease values.

- For temperature and humidity sensors calibration can be done using reference temperature and humidity sensors.
- Wind direction sensor should be calibrated so that the value indicated by the GreenField fits the actual direction pointed by the wind direction sensor.
- The radiation sensor factor should be set as indicated in the calibration sticker supplied with the sensor. The radiation offset should be set to 17 unless specified otherwise.  
See GreenField Irrigation – Part 2 > Sensor specifications > Weather sensor specifications for additional information.

## 10.8 Sensors Logging

The Sensors Logging screen allows you to define which sensors should be logged.

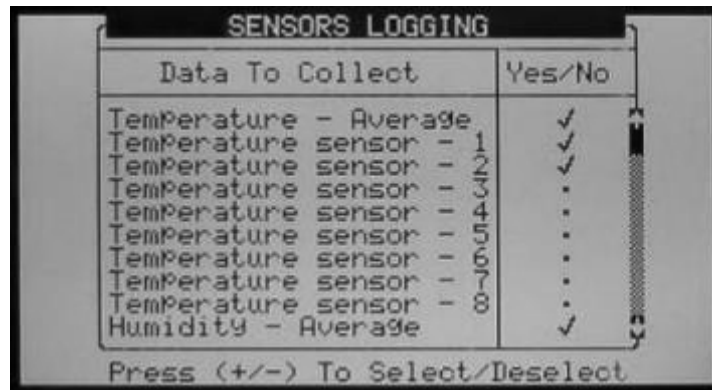

To select an item move the cursor using the arrow keys and mark it using the '+/-' key. Selected items are marked with ✓.

*NOTE* When you change the sensors logging setup, the sensors history table resets and starts over; all sensors data accumulated on the controller is lost.

### 10.9 Write to Data Plug

Use a data-plug to save controller settings and restore them when needed. Plug the data-plug into the GreenField data-plug socket (see Figure 98). The data-plug is symmetric so it can be plugged in both directions.

Enter the WRITE TO DATA PLUG screen and confirm your choice.



*NOTE* When writing to a data-plug, old data on the data-plug will be overwritten.

## 10.10 Read from Data Plug

Use a data-plug to upload and restore controller settings when needed. Plug the data-plug into the GREENFIELD data-plug socket (see the figure below).

*Data-plug*

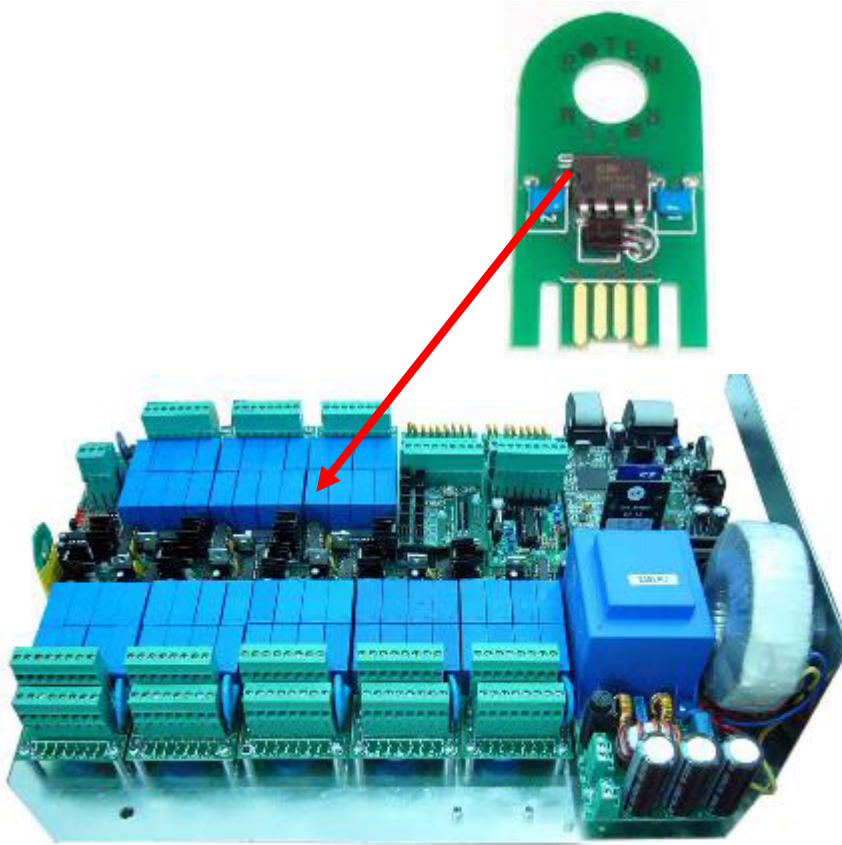

*NOTE* The Data plug should be used when the system is idle; otherwise, some of the running programs might be interrupted and moved to halt.

Enter the READ FROM DATA PLUG screen and confirm your choice.



*NOTE* When reading from the data-plug, the current settings data on the controller will be overwritten.

# 11 Configuration Menu

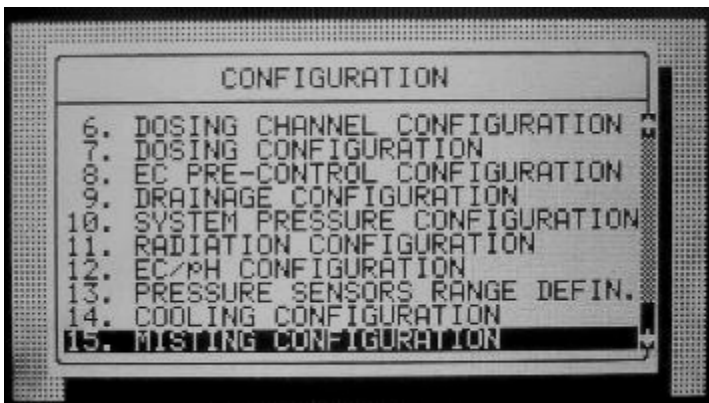
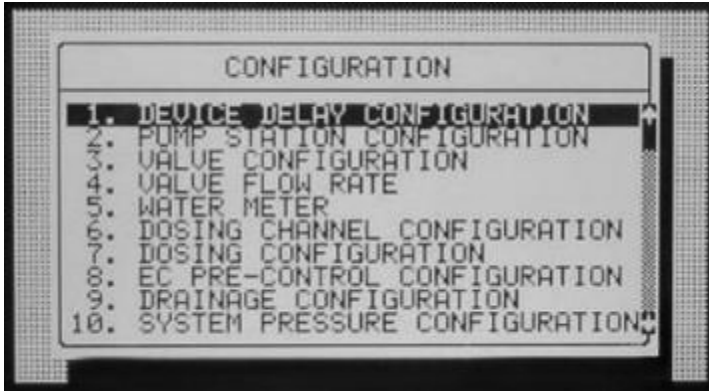

- Device Delay Configuration 119
- Valve Configuration, page 123
- Valve Flow Rate, page 124
- Water Meter, page 125
- Dosing Channel Configuration, page 126
- Dosing Configuration, page 131
- EC Pre-Control Configuration, page 132
- Drainage Configuration, page 133
- System Pressure Configuration, page 133
- EC/pH Range Definition, page 134
- Pressure Sensor Range Definition, page 134
- Cooling Configuration, page 134
- Misting Configuration, page 135

## 11.1 Device Delay Configuration

The Device Delay Configuration screen enables defining the startup and shutdown order of the irrigation process.

DEVICE DELAY CONFIGURATION		
	On mm:ss	Off mm:ss
Pump	--:--	00:35
Main Valve	01:00	00:15
Valve	01:30	--:--
IN-PROGRAM DELAYS		
Shift delay (sec)		-30
Stagger delay (sec)		20

- **On (mm:ss):** On is the definition of the startup order. The set times are taken from procedure startup. The device with the shortest time will be started first and shifted to procedure startup. Therefore it is recommended that the device that is to be started first be set as 00:00 (automatically changes to --:--).
- **Off (mm:ss):** Off is the definition of the shutdown order of the irrigation process. The set times are taken from procedure shutdown. The device with the shortest time will be stopped first and shifted to procedure shutdown. Therefore it is recommended that the device that is to be stopped first be set as 00:00 (automatically changes to --:--).

### 11.1.1 EXAMPLE OF DEVICE STARTUP & SHUTDOWN ORDER

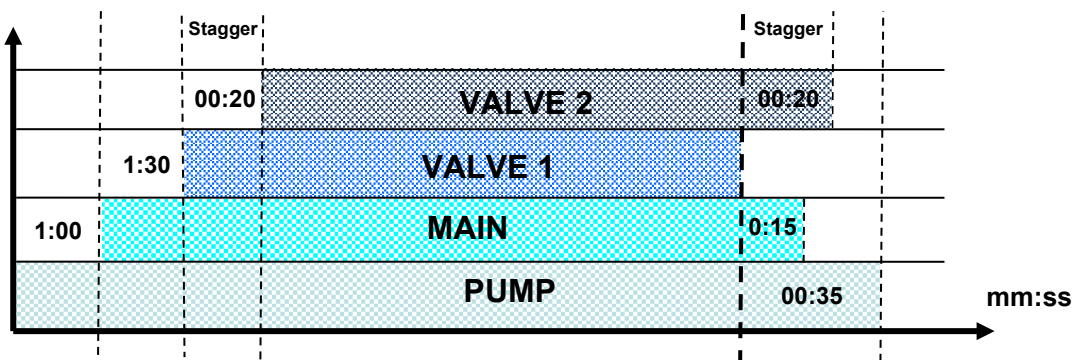

- **Startup:** According to the settings above, the pump will be turned on first (on procedure startup). The main valve will be opened after 1 minute and 30 seconds later (1:30 minutes from procedure startup) the valve.
- **Shutdown:** According to the settings above the valve will be turned off first (on procedure shutdown). The main valve will be closed after 15 seconds and the pump will be closed 20 seconds later (35 seconds from procedure shutdown).

**NOTE** It is recommended that the device that should be started (stopped) first be defined as zero (will appear as --:--).

#### IN-PROGRAM DELAYS

- **Shift delay (sec):** Define the time (in seconds) between each valve change. The shift delay can also be a shift advance by inserting a negative value. This means that the next valve will start before the previous one.

- **Stagger delay (sec):** Define the time (in seconds) for the first shift and the last shift delay between valves (inside of group).

## 11.1.2 EXAMPLE OF STAGGER VALVE DELAY – MULTIPLE SHIFTS

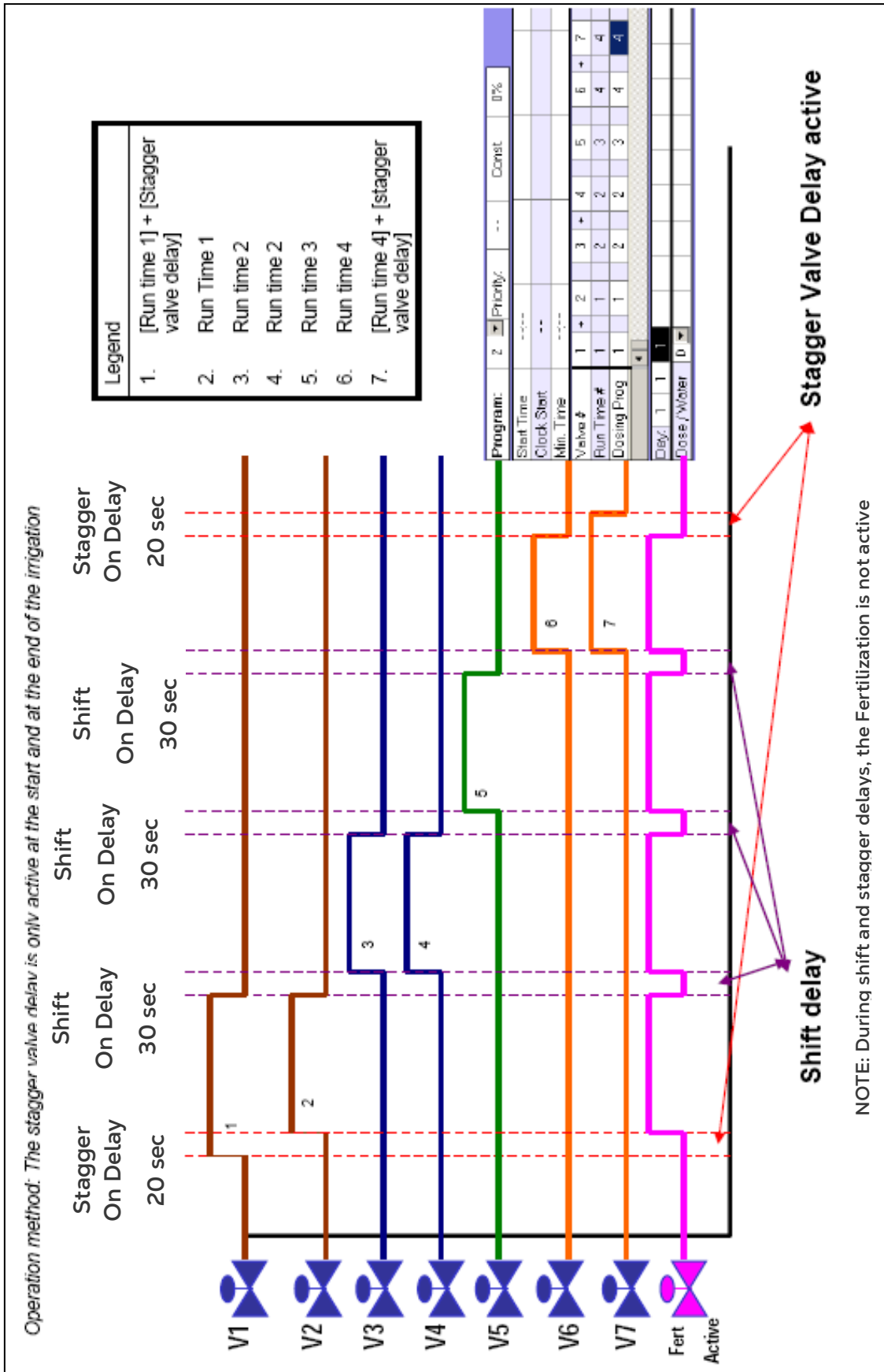

## 11.2 Pump Station Configuration

The GreenField can include up to six pumps. Each valve (irrigation, cooling or misting) can be connected to one of the pumps or to the pump station. The pump station is a group of pumps (out of the six possible pumps) that will be started in accordance with the required flow.

The Pump Station configuration screen allows you to define which pumps are part of the station, the capacity of the various pumps and their startup and shutdown delays.

Pump No.	Capacity m3/h	Stability mm:ss	Off Delay mm:ss
1	5.000	00:20	00:10
2	7.000	00:20	00:10
3	10.000	00:20	00:10
4	---	---	---
5	---	---	---
6	---	---	---

Pump No.	Stability mm:ss	Off Delay mm:ss	Station
1	00:20	00:10	YES
2	00:20	00:10	YES
3	00:20	00:10	YES
4	---	---	NO
5	---	---	NO
6	---	---	NO

The GreenField automatically calculates the expected flow and determines which pump (or pumps) should be started (see [Valve Configuration](#) for additional information regarding flow calculation). The GreenField will start the minimal number of pumps required to supply the calculated flow rate.

If several pumps should be started, the GreenField starts from the largest to the smallest and will turn them off from the smallest to the largest.

- **Pump No.:** Pump number.
- **Capacity:** Define pump capacity in m3 or gallon. This will be the maximum pump capacity, above which the GreenField will turn on another pump (if available).
- **Stability (mm:ss):** Define stability time. Stability time is the startup time required for current pump before next pump can be started up. Stability time is usually used to prevent voltage drop down and water hammer (see [Pump Startup Order](#) schema).
- **Off Delay (mm:ss) :** Define off delay. Off delay will be the delay time for current pump to stop after last pump has stopped. This delay is usually used to prevent water hammer (see [Pump Shutdown Order](#) schema).
- **Station (Yes/No):** Define whether the pump is part of the pump station.

The following is a startup and shutdown order schema according to the settings above and a calculated flow rate of 60 m<sup>3</sup>/h:



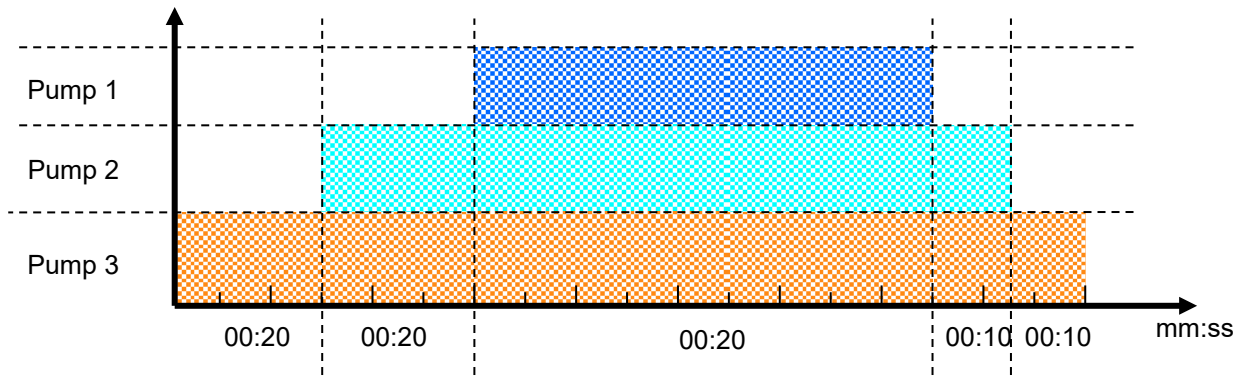

Pump startup & shutdown order

### 11.3 Valve Configuration

Valve configuration allows you to configure devices such as pumps, main valves and drainage measurement of valves.

VALVE CONFIGURATION				
Valve No.	Pump	Main Valve	Water Meter	Drain Meter
115	Pump 2	1	2	2
116	Station	1	1	3
117	Pump 3	1	3	3
118	Station	1	1	4
119	Pump 4	1	4	4
120	Station	1	1	1
121	Pump 2	1	1	1
122	Station	1	1	1
123	Pump 4	1	1	1
124				

VALVE CONFIGURATION				
Valve No.	Main Valve	Water Meter	Drain Meter	Drain Type
115	1	2	2	Sample
116	1	1	3	Total
117	1	3	3	Sample
118	1	1	4	Total
119	1	4	4	Sample
120	1	1	1	Total
121	1	1	1	Total
122	1	1	1	Total
123	1	1	1	Total
124				Total

VALVE CONFIGURATION				
Valve No.	Water Meter	Drain Meter	Drain Type	Sample %
115	2	2	Sample	50.0000%
116	1	1	Total	-----
117	3	3	Sample	80.0000%
118	1	1	Total	-----
119	4	4	Sample	100.0000%
120	1	1	Total	-----
121	1	1	Total	-----
122	1	1	Total	-----
123	1	1	Total	-----
124	1	1	Total	-----

- **Valve No.:** Indication of the valve number.
- **Pump:** Define which pump or pump station should be started when irrigating this valve. When choosing Station, the GreenField will choose which and how many pumps should be started to supply the required (calculated) flow. See Pump Station Configuration on page 122 for more information).
- **Main Valve:** Define which main valve should be opened when starting each valve.
- **Water Meter:** Configure a water meter to each valve. This option is only possible when the flow calculation (water meter type) is Standard.

*NOTE Make sure that you define an operative water meter. There is no protection against defining a water meter that isn't properly defined in the system.*

Note that when operating using Water Source (unlike Standard, in table 7.5) a valve is not configured to a specific water meter. In this case, all water meters set in the system are relevant for each irrigation and their pulses are calculated for the flow rate, hence, water meter column will be ignored in valve configuration table.

*NOTE Make sure that you define an operative water meter. There is no protection against defining a water meter that isn't properly defined in the system.*

*NOTE When using more than one water meter it is recommended not to start to valves that are not configured to the same water meter simultaneously; the GreenField uses only the water meter connected to the leading valve and does not sum the flow from the rest of the water meters, this might create unexpected alarms and malfunctions!*

- **Drain Meter:** Define which drain meter this valve is connected to.
- **Drain Type:** Define drainage type:

- **Total:** Drainage is collected from the complete valve area.
- **Sample:** Drainage is collected from a representing part of the valve area.

Note that it is possible to set several valves to the same drain meter when working by 'Total'. The system does not allow operating several valves on the same meter when operating by 'Sample'.

- **Sample %:** When using sample drainage measurement it is required to define the ratio of the sample area to the complete valve area.

## 11.4 Valve Flow Rate

VALVE FLOW RATE			
Valve No.	Nominal m3/h	Minimum m3/h	Maximum m3/h
51	5.000	3.750	6.250
52	19.000	14.250	23.750
53	20.000	15.000	25.000
54	22.000	16.500	27.500
55	13.000	9.750	16.250
56	15.000	11.250	18.750
57	22.000	16.500	27.500
58	30.000	22.500	37.500
59	11.000	8.250	13.750
60	14.000	10.500	17.500

VALVE FLOW RATE			
Valve No.	Nominal m3/h	Minimum m3/h	Maximum m3/h
246	5.000	3.750	6.250
247	13.000	9.750	16.250
248	16.000	12.000	20.000
249	19.000	14.250	23.750
250	4.000	3.000	5.000
251	23.000	17.250	28.750
252	18.000	13.500	22.500
253	25.000	18.750	31.250
254	5.000	3.750	6.250
255	22.000	16.500	27.500

- **Nominal:** Define nominal valve flow rate (m3/h or gallon/min). The GreenField uses the set nominal flow rate for calculating the ratio between valves when starting a few valves together, the boundaries for alarms, the total flow rate for calculating how many pumps to start, etc. Therefore it is recommended to try and set the nominal flow rate as close as possible to the actual flow rate.
- **Minimum:** Minimum valve flow rate, under which the system will generate a low flow alarm. When changing the Nominal flow rate this setting is automatically set to 25% under the nominal flow, and can be manually changed.
- **Maximum:** Maximum valve flow rate, above which the system will generate a high flow alarm. When changing the nominal flow rate this setting is automatically set to 25% above the nominal flow, and can be manually changed.

*NOTE* When starting several valves simultaneously the system will sum their nominal, minimal and maximal flow rates. An alarm will be generated only if the measured flow rate is lower than the total minimum, or higher than the total maximum.

*NOTE* When starting several valves simultaneously, the quantities between them will be divided based on the ratio of their nominal flow.

## 11.5 Water Meter

- **Ratio:** Set volume per pulse of each water meter or auxiliary meter.
- **Type:** Define type of flow calculation:
  - **Standard:** In this function valves which are operated in a group should be connected to the same water meter.

*NOTE If a few valves configured to different water meters will be started simultaneously, the GreenField uses the flow measured by the water meter connected to the leading valve.*

- ♦ **Water source:** The GreenField will sum or deduct flow measured simultaneously from a few water meters. When choosing this function an additional column called "SUM" will appear, this column enables to define which water meters should be summed and which deducted from the total measured flow.

*NOTE Flow calculation type is a general definition for all water meters, therefore when changing type of water meter for one of the water meters the type will be changed for all water meters.*

*NOTE When setting flow calculation (water meter type) to Water source it is not possible to configure valves to water meters.*

- **Sum:** Define whether flow measured by each water meter should be added to the total measured flow or deducted:
  - "+" Flow measured by this water meter will be added to the total measured flow.
  - "-" Flow measured by this water meter will be deducted from the total measured flow.

*NOTE Since flow cannot be negative, if the controller measures negative flow it will show zero.*

*NOTE If all valves are set to "-" the system will ignore the measured flow and will use the calculated flow (based on the nominal flow).*

WATER METER		
Description	Ratio	Type
Water Meter 1(L/P)	10.000	W.SOURCE
Water Meter 2(L/P)	20.000	W.SOURCE
Water Meter 3(L/P)	50.000	W.SOURCE
Water Meter 4(L/P)	100.000	W.SOURCE
Water Meter 5(L/P)	10.000	W.SOURCE
Water Meter 6(L/P)	-----	W.SOURCE
AUX Meter 1(L/P)	-----	-----
AUX Meter 2(L/P)	-----	-----
AUX Meter 3(L/P)	-----	-----
AUX Meter 4(L/P)	-----	-----
AUX Meter 5(L/P)	-----	-----

WATER METER		
Description	Type	Sum
Water Meter 1(L/P)	W.SOURCE	+
Water Meter 2(L/P)	W.SOURCE	+
Water Meter 3(L/P)	W.SOURCE	+
Water Meter 4(L/P)	W.SOURCE	+
Water Meter 5(L/P)	STANDARD	-
Water Meter 6(L/P)	W.SOURCE	+
AUX Meter 1(L/P)	-----	-----
AUX Meter 2(L/P)	-----	-----
AUX Meter 3(L/P)	-----	-----
AUX Meter 4(L/P)	-----	-----
AUX Meter 5(L/P)	-----	-----

WATER METER		
Description	Ratio	Type
Water Meter 1(L/P)	10.000	STANDARD
Water Meter 2(L/P)	20.000	STANDARD
Water Meter 3(L/P)	50.000	STANDARD
Water Meter 4(L/P)	100.000	STANDARD
Water Meter 5(L/P)	10.000	STANDARD
Water Meter 6(L/P)	-----	STANDARD
AUX Meter 1(L/P)	-----	-----
AUX Meter 2(L/P)	-----	-----
AUX Meter 3(L/P)	-----	-----
AUX Meter 4(L/P)	-----	-----
AUX Meter 5(L/P)	-----	-----

*NOTE It is very important to choose the correct flow meter for the application. Choosing a wrong flow meter might result in measurement errors or an inaccurate control. For instructions regarding how to choose the correct water meter see GreenField Irrigation > General > Flow meter determination.*

## 11.6 Dosing Channel Configuration

DOSING CHANNEL CONFIGURATION			
No.	Pump	Method	Ratio
1	Analog	Time (Lit/h)	300.000
2	Analog	Time (Lit/h)	300.000
3	Venturi	Time (Lit/h)	150.000
4	Venturi	Time (Lit/h)	200.000
5	Analog	Time (Lit/h)	150.000
6	Venturi	Time (Lit/h)	150.000
7	Venturi	Time (Lit/h)	150.000
8	Venturi	Time (Lit/h)	150.000

DOSING CHANNEL CONFIGURATION			
No.	Ratio	React	High (%)
1	300.000	EC	50
2	300.000	EC	50
3	150.000	pH	50
4	200.000	pH	50
5	150.000	EC	50
6	150.000	EC	50
7	150.000	pH	50
8	150.000	pH	50

DOSING CHANNEL CONFIGURATION			
No.	High (%)	Low(%)	V/P(L)
1	50	20	0.100
2	50	20	0.100
3	50	20	0.100
4	50	20	0.100
5	50	20	-----
6	50	20	-----
7	50	20	-----
8	50	20	-----

- **Pump:** Select the type of dosing pump:
  - **Venturi:** The dosing unit consists of Venturi driven injectors. The dosing booster will be turned on when fertigation is active (refer to the following section).
  - **Hydraulic:** The dosing unit consists of hydraulic fertilizer pumps. The dosing booster is not needed and will not be turned on when Fertigation is active. When working with hydraulic pump, the method can only be Liter/Pulse and EC & pH control is not possible.
  - **Electric:** The dosing unit consists of electrical fertilizer pumps. The dosing booster is not needed and will not be turned on when Fertigation is active.
  - **Analog:** This dosing unit consists of pumps controlled by 4 – 20 mA analog output. Define the analog outputs in Analog Output Definition, page 47.

**NOTE** *Calibrate the analog and Venturi dosing pumps. Refer to the following sections.*

- **Method:** Select the operating method:
  - **Liter/Pulse:** Define whether a dosing meter is connected to this channel and used for control purposes. Set the volume per pulse on the Ratio column.
  - **Time (cc/sec):** Define whether the calculated flow rate of the dosing channel is in CC (gallons) of fertilizer per second.
  - **Time (Liter/min):** Define whether the calculated flow rate of the dosing channel is in liters (gallons) per minute.
  - **Time (Liter/Hour):** Define whether the calculated flow rate of the dosing channel is in liters (gallons) per Hour (default option).
- **Ratio**
  - **Method is Time:** Define calculated flow rate, this will be the flow rate of the channel when completely open.
  - **Method is Liter/Pulse:** Define the volume per pulse.
- **React:** Set the required use of the channel:
  - **EC:** The channel is used to increase measured EC, meaning it will be opened more when the measured EC is lower than the set EC.
  - **pH:** The channel is used to decrease measured pH, meaning it will be opened more when the measured pH is higher than the set pH.
  - **Passive:** The channel does not respond to changes in measured EC/pH, meaning it will be opened as set in the dosing program regardless of the EC/pH values.
  - **Alkali:** The channel is used to increase measured pH, meaning it will be opened more when the measured pH is lower than the set pH.

**NOTE** *If EC/pH control is off, or the channel is used for proportional injection only (for example in order to inject chemicals) set reaction to passive.*

- **High %:** set an injection percentage limit. This percentage will limit the deviation from set dosing recipe when GreenField is injecting more than specified in order to try and reach the target EC/pH values.
- **Low %:** set an injection percentage limit. This percentage will limit the deviation from set dosing recipe when GreenField is injecting less than defined in order to try and reach the target EC/pH values.
- **V/P(L/G):** This parameter will be disabled when operating by Liter/Pulse. Define the volume per pulse of the dosing meter (liters or gallons). Only required when using a dosing meter for measurement and alarm purposes. When using a dosing meter for control purposes the volume per pulse of the dosing meter should be defined on the Ratio column. The letter between the brackets indicates whether the volume units are in Liter or Gallon.

### 11.6.1 CALIBRATING THE ANALOG DOSING VALVES

Analog dosing valves must be calibrated before using them. A 4 – 20 mA signal controls the valves; however, there can be differences between the current flow and the actual fertilizer flow provided. Therefore, analog-driven injectors must be calibrated.

- Before beginning, turn off all EC pH alarms. During calibration, fertilizers are distributed at levels that can (unnecessarily) trigger alarms.
- During calibration, the irrigation system must operate in manner that is representative of how the system operates in actuality. Doing so enables accurate calibration. Operate the irrigation system manually at a level that it is typically used.
- Calibrate each analog channel separately!

How to calibrate:

1. Manually open the analog dosing channel to 100%. The Visual Flow Meter displays the dosing channel flow rate.
2. In *Configuration > Dosing Channel Configuration (7.6)*, insert this value in the Ratio field.
3. Close the analog dosing channel to 10%.
4. In *Configuration > Dosing Channel Configuration*, click the  icon. A drop down list appears.

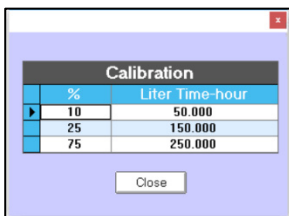

5. Record the dosing channel flow in the field labeled "10%".
6. Repeat this step for 25% and 75% and record the values in the respective fields. The following figure shows an example calibration.

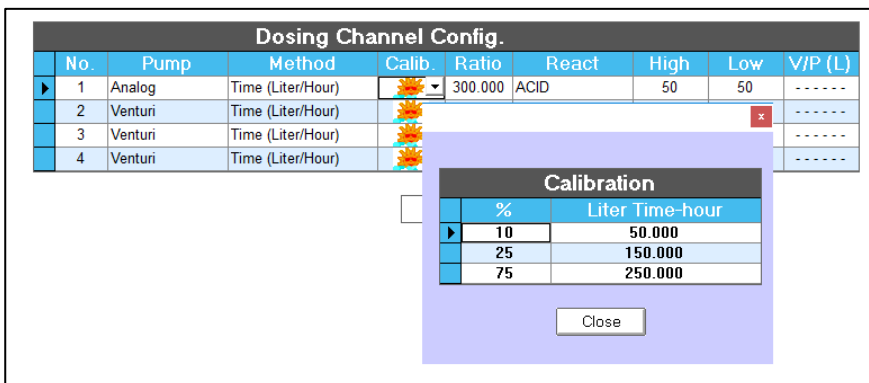

7. Repeat this procedure for each analog dosing channel.
8. After completing the calibration, reactivate the EC pH alarms.

The following graphs is an example of how fertilizer is distributed after calibration. The green line represents linear (digital) control; the red line represents the actual amount of fertilizer to be distributed after calibration with the analog dosing valve.

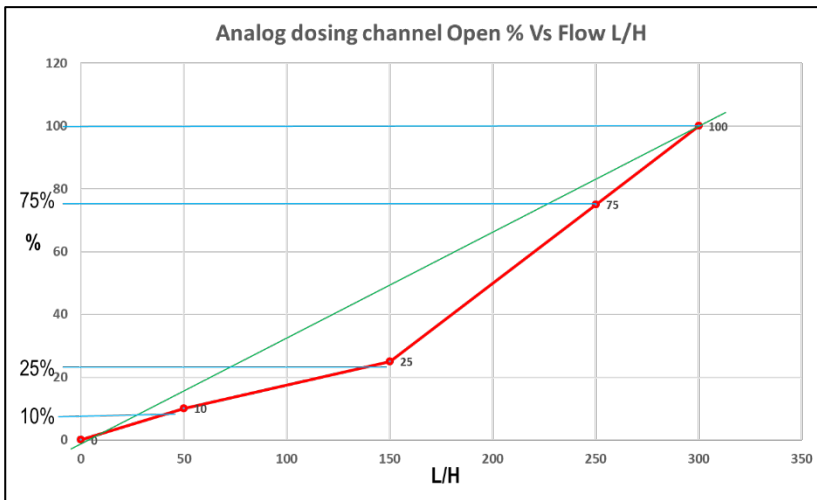

### 11.6.2 CALIBRATING THE VENTURI PUMPS

The following section details how to calibrate the dosing valve when using Venturi Pumps.

1. Ensure that all dosing channels are physically connected to the fertilizer tanks.

*NOTE For purposes of calibrating the dosing, the tanks can be filled with water.*

2. Verify that the needle valve is completely open (100%).
3. Go to Testing > Relays.
4. Manually operate the Irrigation Program and Dosing Booster.
5. Go to Test > Analog Output.
  - a. Set the status as Manual.
  - b. Define all openings as 25%.
  - c. Check the injection rate/fertilizing rate on the Rotameter.



Example: If the observed rate is 100 liters per hour when set at 25%, the maximum rate should be 400 liters per hour (formula:  $100 / 0.25 = 400$ ).

*NOTE Even when the Venturi capacities are the same, and the opening percentage is the same for each valve, there can be small variations in the actual flow rate.*

*NOTE Be aware that when you use water to calibrate the Rotameter valves, there can be different reading when fertilizer is actually used.*

6. Go to Configuration > Dosing Channel Configuration.

7. Under Ratio, enter the calculated injection rate/fertilizing rate. In the following screen, these numbers would be changed to 400 (the result of the equation shown in step 5c).

No.	Pump	Method	Ratio
1	Analog	Time(Lit/h)	460.000
2	Analog	Time(Lit/h)	480.000
3	Analog	Time(Lit/h)	456.000
4	Analog	Time(Lit/h)	420.000

8. To fine tune the ratio:

- Prepare an Irrigation Program using the most common dosing capacity program.
- Run the program.
- Check the actual flow on the Rotameter.
- Adjust all Rotameters to the same flow by adjusting the Ratio settings as needed.

*NOTE Decreasing the flow in the controller settings increases the actual flow seen in the Rotameter.*

*NOTE The goal of this process is to equate (to the greatest extent possible) the Rotameter's actual flow rate to the flow rate shown in Hot Key 4.*

Chan.	Open %	Min %	Prg %	Max %	Flow
1	64	31	62	93	258
2	64	31	62	93	258
3	64	31	62	93	258
4	18	9	18	27	74
5	---	---	---	---	---



## 11.7 Dosing Configuration

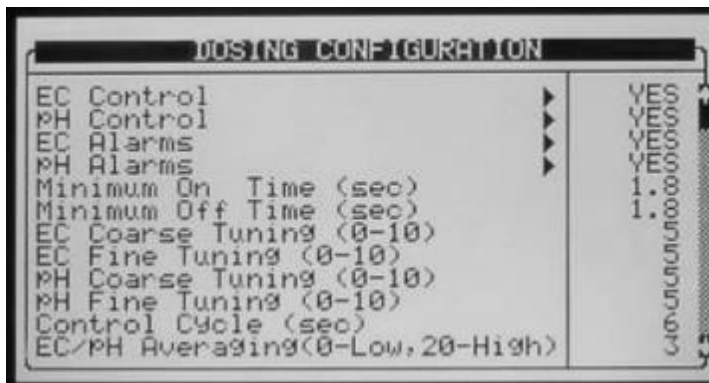

- **EC Control:** Define whether EC control should be operative.
- **pH Control:** Define whether pH control should be operative.
- **EC Alarms:** Define whether EC related alarms are operative. When EC control is set to 'Yes', EC Alarms are automatically set to 'Yes' and cannot be changed.
- **pH Alarms:** Define whether pH related alarms are operative. When pH control is set to 'Yes' pH Alarms are automatically set to 'Yes' and cannot be changed.
- **Minimum On Time (sec):** Define the minimum time the dosing regulator may be opened for. This feature is used to protect the regulator from being excessively turned on and off. The minimum allowed on time is 0.4 seconds.
- **Minimum Off Time:** Define the minimum time the dosing regulator may be turned off. This feature is used to protect the regulator from being excessively turned on and off. The minimum On time allowed is 0.4 seconds.
- **EC Coarse Tuning (0-10):** EC Coarse Tuning is used to adjust the speed and strength of the EC control. A higher value will result in faster correction but might lead to over shooting (see Appendix 1 – General > EC/pH correction adjustment for further information).
- **EC Fine Tuning (0-10):** EC Fine Tuning is used to fine tune the EC control shooting (see GreenField Irrigation > Part 2 > General > EC/pH correction adjustment for further information).
- **pH Coarse Tuning (0-10):** pH Coarse Tuning is used to adjust the speed and strength of pH control. A higher value will result in faster correction but might lead to over shooting (see GreenField Irrigation > Part 2 > General > EC/pH correction adjustment for further information).
- **pH Fine Tuning (0-10):** pH Fine Tuning is used to fine tune pH control shooting (see GreenField Irrigation > Part 2 > General > EC/pH correction adjustment for further information).
- **EC Control Cycle (sec):** Define the control cycle for EC control. This should be the time it takes the system since it injected fertilizer/acid until the change in recognized by the system.
- **pH Control Cycle (sec):** Define the control cycle for pH control. This should be the time it takes the system since it injected fertilizer/acid until the change in recognized by the system.
- **EC/pH Averaging (0-Low, 20-High):** Averaging factor for EC/pH measurement. EC/pH averaging should be used to enable correction when injection is not homogenous.

- **Dosing Booster Off Delay (mm:ss):** Define the time that the dosing booster should be left on after dosing has ended. This time is usually used to circulate the acid and nutrients in order to prevent high concentrations in the area of the ventureries and dosing booster when the system is idle.
- **Dosing by QTY. Method:**
  - **Bulk:** All channels set to QTY (quantity) dosing method will inject the set quantity in one bulk, starting after water before quantity/time has elapsed.
  - **Spread Out:** The set dosing quantity of all channels set to QTY (quantity) dosing method will be spread throughout the irrigation.

## 11.8 EC Pre-Control Configuration

EC Pre-Control Configuration	
EC Pre-Control Runtime	01:50
EC Pre-Control Control Cycle	00:06
Coarse Tuning	5
Fine Tuning	5
EC Pre-Control Pump	
Start With First/Last Device	First
Off Delay	00:15

- **EC Pre-Control Configuration:**
  - **EC Pre-Control Runtime:** Set the time it takes the EC Pre-Control valve to shift from fully closed to fully open. This parameter is very important and must be exact as the controller uses this parameter to calculate the opening percentage of the EC Pre-Control valve.
  - **EC Pre-Control Control Cycle:** Set the time it takes since the EC Pre-Control valve changes position until the change is measured by the EC Pre-Control sensor.
  - **Coarse Tuning:** Coarse Tuning is used to adjust control speed and strength. A higher value will result in faster correction but might lead to over-closing, a lower value might result in slow reaction.
  - **Fine Tuning:** Fine Tuning is used to fine tune EC Pre-Control behavior.
- **EC Pre-Control Pump:**
  - **Start With First/Last Device:** Define whether the EC Pre-Control Pump should open with the first or the last device of the irrigation (refer to table 1.3 to see device startup order).
  - **Off Delay:** Define Off delay (if required) for the EC Pre-Control pump.

## 11.9 Drainage Configuration

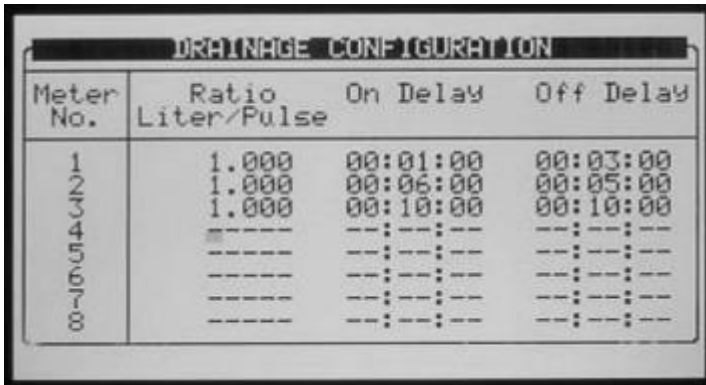

Meter No.	Ratio Liter/Pulse	On Delay	Off Delay
1	1.000	00:01:00	00:03:00
2	1.000	00:06:00	00:05:00
3	1.000	00:10:00	00:10:00
4	----	--:--:--	--:--:--
5	----	--:--:--	--:--:--
6	----	--:--:--	--:--:--
7	----	--:--:--	--:--:--
8	----	--:--:--	--:--:--

- **Ratio:** Define volume per pulse of the drainage meters (liter/pulse or gallon/pulse).
- **On Delay:** Define how long a valve, which is configured to this drainage measurement, should be open before the measured drainage is related to this valve. All drainage measured before this time has elapsed (although the valve is open) will still be related to the previous opened valve that was configured to this drainage sump.
- **Off Delay:** Define how long after irrigation has finished, the measured drainage should still be related to the previous irrigation. This value is used to “tell” the controller when to stop relating drainage to the previous irrigation and write it to all relevant history tables.

## 11.10 System Pressure Configuration

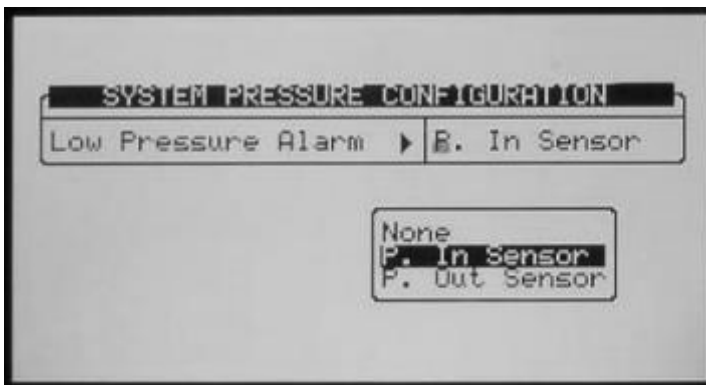

Define which pressure sensor (inlet or outlet) should be used as the system’s pressure. This sensor can later be defined to stop the system in case of low pressure (see table 1.7).

## 11.11 EC/pH Range Definition

EC/pH CONFIGURATION			
Sensor	4 mA	20 mA	Sensor Dif.
EC 1	0	10	
PH 1	0	14	
EC 2	0	10	----
PH 2	0	14	----
EC P	0	20	
EC Control Sensor	▶		EC 1+EC 2
PH Control Sensor	▶		PH 1+PH 2

Define the range of the EC/pH transmitters.

- Default settings for Munters EC/pH transmitters is:
  - EC: zero to 10 mS
  - PH: zero to 14 ppm
- EC Control Sensor: Define which EC sensor should be used for control. When setting EC 1 + EC 2, EC1 will be used for control, and EC2 will be used for verification.
- pH Control Sensor: Define which pH sensor should be used for control. When setting pH 1 + pH 2, pH1 will be used for control, and pH2 will be used for verification.

## 11.12 Pressure Sensor Range Definition

PRESSURE SENSORS RANGE DEFINITION		
Sensor ▶	0 Volt	5 Volt
Pin (bar)	0.00	10.00
Pout (bar)	0.00	10.00

- 0 – 5 Volt or 4 – 20 mA: Use the arrow keys to move the cursor to the 0 Volt (4 mA), press ENTER to switch between 0 – 5 Volt and 4 – 20 mA.
- 0 Volt (4 mA): Define the pressure (bar or PSI) that should be presented when 0 volts (4 mA) is read by the GreenField.
- 5 Volt (20 mA): Define the pressure (bar or PSI) that should be presented when 5 Volts (20 mA) is read by the GreenField.

The GreenField will create a linear graph between the 0 Volt (4 mA) to the 5 Volt (20 mA).

## 11.13 Cooling Configuration

The cooling configuration screen will only be visible after one (or more) cooling valves have been defined in the [DEVICE LAYOUT](#) table.

COOLING CONFIGURATION		
Cool No.	Pump	Main Valve
1	2	1
2	3	1

- **Pump:** Configure a pump to each cooling valve. This setting is not necessary if the cooling pump is not controlled by the GreenField.
- **Main Valve:** Configure a main valve to each cooling valve. This setting is not necessary if the cooling doesn't have a main valve.

### 11.14 Misting Configuration

MISTING CONFIGURATION		
Mist. No.	Pump	Main Valve
1	1	1

- **Pump:** Configure a pump for each misting valve. This setting is not necessary if the misting pump is not controlled by the GreenField.
- **Main Valve:** Configure a main valve to each misting valve. This setting is not necessary if the misting doesn't have a main valve.

# 12 Installation Menu

INSTALLATION	
1	DEVICE LAYOUT
2	DEVICE LIST
3	DIGITAL INPUT
4	ANALOG INPUT 1
5	ANALOG INPUT 2
6	ANALOG OUTPUT
7	HARDWARE CHECKLIST

- Device Layout, page 136
- Device List, page 138
- Digital Input, page 138
- Analog Input 1-2, page 139
- Analog Output, page 142
- Hardware Checklist, page 142

## 12.1 Device Layout

The device layout screen allows you to assign functions to each output (relay).

1. Place the cursor on the Function column, use the arrow keys to reach the relevant line, and press **ENTER**. A selection list including all available devices will appear.
  2. Choose the required device and confirm by pressing **ENTER**. The cursor will move to the No. column.
  3. Specify the number of the device in the controller and press **ENTER** to confirm.
  4. If you wish to define several devices of the same type, for example valves 1 to 10, configure the first one and press **ENTER** a few times until you reach the required amount. The GreenField automatically continues with the same device until instructed otherwise, or until reaching the system limitation for that device.
- **Relay:** This column is divided to two sub-columns indicating relay number and the location of the relay card;
    - **Local:** Numbers 1 to 64 and the card exists.
    - **EXT 1:** Numbers 65 to 128 and the card exists.
    - **EXT 2:** Numbers 129 to 196 and the card exists.
    - **EXT 3:** Numbers 197 to 256 and the card exists.

*NOTE* If the card does not exist, the column can show either 'N/A' (see Screen 4 on next page) or 'R.U.' (see Screen 5 on next page), according to parameter "Remote Unit Type" in table 6.2.

NOTE If a selected value is different than 'None' in table 6.2, 'R.U.' is displayed in this table (see Screen 5 on next page).

NOTE If 'SingleNet' is chosen in table 6.2, the screen consists of 256 outputs.

NOTE If 'Radio' is selected in table 6.2, the screen contains at least 64 outputs.

Screen 1

DEVICE LAYOUT		
Relay	Function	No.
LOCAL	1	Dosing Channel
LOCAL	2	Dosing Channel
LOCAL	3	Dosing Channel
LOCAL	4	Dosing Channel
LOCAL	5	Dosing Channel
LOCAL	6	Dosing Channel
LOCAL	7	Dosing Channel
LOCAL	8	Dosing Channel
LOCAL	9	Dosing Channel
LOCAL	10	Dosing Booster
LOCAL	11	Pump

Screen 2

DEVICE LAYOUT		
Relay	Function	No.
LOCAL	62	Same As Relay
LOCAL	63	Same As Relay
LOCAL	64	Same As Relay
EXT1	65	Valve
EXT1	66	Valve
EXT1	67	Valve
EXT1	68	None
EXT1	69	None
EXT1	70	None
EXT1	71	None

Screen 3

DEVICE LAYOUT		
Relay	Function	No.
EXT1	125	None
EXT1	126	None
EXT1	127	Same As Relay
EXT1	128	Valve
EXT1	129	Valve
EXT2	130	Valve
EXT2	131	Valve
EXT2	132	None
EXT2	133	None
EXT2	134	None

Screen 4

DEVICE LAYOUT		
Relay	Function	No.
N/A	247	None
N/A	248	None
EXT3	249	None
EXT3	250	None
EXT3	251	None
EXT3	252	None
EXT3	253	None
EXT3	254	None
EXT3	255	Same As Relay
EXT3	256	Valve

Screen 5

DEVICE LAYOUT		
Relay	Function	No.
EXT1	76	None
EXT1	77	None
EXT1	78	None
EXT1	79	None
EXT1	80	None
EXT1	81	None
EXT1	82	None
EXT1	83	None
EXT1	84	None
EXT1	85	None
EXT1	86	None

*NOTE After making changes, be sure to exit and return again to check for errors. The GreenField will delete and replace conflicting assignments with '---'.*

## 12.2 Device List

The Device List screen allows you to view what type, and how many devices are currently defined. This screen automatically updates depending on the devices set in the 7.1 screen.

DEVICE LIST	
Type	Qty.
Valves	3
Main Valves	1
Pumps	2
Filters	2
Main Filter Valve	---
Dosing Channels	4
Dosing Boosters	---
Selectors	---
Agitators	---
Cooling	2

## 12.3 Digital Input

Place the cursor on the relevant line and press ENTER. A selection list will open. Choose the required sensor and press ENTER to confirm.

Inputs 1-32 are according to the following:

- Card no. 1: inputs 1 – 8
- Card no. 2: inputs 9 – 16
- Card no. 3: inputs 17 – 24
- Card no. 4: inputs 25 – 32

DIGITAL INPUT		
In	Input Function	
LOCAL	1	Water Meter 1
LOCAL	2	Dosing Meter 1
LOCAL	3	Dosing Meter 2
LOCAL	4	< None >
LOCAL	5	< None >
LOCAL	6	< None >
LOCAL	7	< None >
LOCAL	8	< None >
EXT3	9	Water Meter 2
EXT3	10	< None >

DIGITAL INPUT		
In	Input Function	
EXT1	17	Water Meter 3
EXT1	18	External Pause
EXT1	19	< None >
EXT1	20	< None >
EXT1	21	< None >
EXT1	22	< None >
EXT1	23	< None >
EXT1	24	< None >
EXT2	25	Water Meter 4
EXT2	26	Delta Pressure



NOTE If the cards do not exist, either 'N/A' or 'R.U' will be displayed, according to parameter "Remote Unit Type" in table 6.2.

NOTE This table refers to both local and extension boxes.

NOTE The card number is set according to its jumpers regardless to its location (local or extension box).

## 12.4 Analog Input 1-2

1. In *Installation > Analog Input 1*, define input function(s) as Analog Sensors.

ANALOG INPUT No. 1			
Channel		Input Function	No.
LOCAL	1	<None>	-
LOCAL	2	<None>	-
LOCAL	3	<None>	-
LOCAL	4	<None>	-
LOCAL	5	<None>	-
LOCAL	6	<None>	-
LOCAL	7	<None>	-
LOCAL	8	<None>	-
LOCAL	9	<None>	-

ANALOG INPUT No. 1			
Channel		Input Function	No.
LOCAL	1	<Non	
LOCAL	2	<Non	
LOCAL	3	<Non	08. Out Temp.
LOCAL	4	<Non	09. Out Humidity
LOCAL	5	<Non	10. Radiation
LOCAL	6	<Non	11. Wind Direction
LOCAL	7	<Non	12. Pressure In
LOCAL	8	<Non	13. Pressure Out
LOCAL	9	<Non	14. Rain Sensor
LOCAL	10	<Non	15. EC Drain Sensor
LOCAL		<Non	16. Analog Sensor

2. If required, in *Installation > Analog Input 1*, define the Expansion Channels.

ANALOG INPUT No. 1			
Channel		Input Function	No.
EXP1	12	EC Sensor	1
EXP1	13	pH Sensor	1
EXP1	14	Temp. Sensor	2
EXP1	15	Radiation	3
EXP1	16	<None>	-
EXP1	17	<None>	-
EXP1	18	<None>	-
EXP1	19	<None>	-
EXP1	20	<None>	-

3. In *Installation > Analog Input 2*, define input function(s) as Analog Sensors.

ANALOG INPUT No. 2			
Channel		Input Function	No.
LOCAL	1	<None>	-
LOCAL	2	<None>	-
LOCAL	3	<None>	-
LOCAL	4	<None>	-
LOCAL	5	<None>	-
LOCAL	6	<None>	-
LOCAL	7	<None>	-
LOCAL	8	<None>	-
LOCAL	9	<None>	-

ANALOG INPUT No. 2			
Channel		Input Function	No.
LOCAL	1	<Non	
LOCAL	2	<Non	
LOCAL	3	<Non	08. Out Temp.
LOCAL	4	<Non	09. Out Humidity
LOCAL	5	<Non	10. Radiation
LOCAL	6	<Non	11. Wind Direction
LOCAL	7	<Non	12. Pressure In
LOCAL	8	<Non	13. Pressure Out
LOCAL	9	<Non	14. Rain Sensor
LOCAL	10	<Non	15. EC Drain Sensor
LOCAL		<Non	16. Analog Sensor

4. If required, in *Installation > Analog Input 2*, define the Expansion Channels.

NOTE Define up to 88 sensors.

ANALOG INPUT No. 2			
Channel		Input Function	No.
EXP1	12	EC Sensor	1
EXP1	13	pH Sensor	1
EXP1	14	Temp. Sensor	2
EXP1	15	Radiation	3
EXP1	16	<None>	-
EXP1	17	<None>	-
EXP1	18	<None>	-
EXP1	19	<None>	-
EXP1	20	<None>	-

5. In *Setup > Analog Conversion Table*:

- Select the sensor type.
- Enter the required value in the minimum value column.
- Enter 100 in the maximum value column.

ANALOG CONVERSION TABLE			
Num.	Sensor Type	Min Value	Max Value
1	<->	<->	<->
2	<->	<->	<->
3	<->	<->	<->
4	<->	<->	<->

ANALOG CONVERSION TABLE			
Num.	Sensor Type	Min Value	Max Value
1		5	100
2	<NONE>	5	100
3	ECh20	10	100
4		6	100
	Gen. Sensor Temperature		

6. In *Test > Analog Sensor*, view the actual sensor values.

ANALOG SENSOR		
No.	Type	Value
1	Gen. Sensor	24
2	Gen. Sensor	24
3	ECh20	7
4	ECh20	7
5	ECh20	7
6	Temperature	21
7	Temperature	21
8	<None>	
9	<None>	
10	<None>	

7. In *Program > Ext Condition*, configure the External Condition Program for the analog sensors.

- Enter the beginning and ending time for each program.
- Under Start An. Dry Cont., define the input type.

EXTERNAL CONDITION PROGRAM			
#	From hh:mm	To hh:mm	Start An. Dry Cont.
1	10:00	12:00	Ana. Sen 1
2	11:00	12:00	Dry Con 1
3	12:00	13:00	Dry Con 1
4	--:--	--:--	<NONE>
5	--:--	--:--	<NONE>
6	--:--	--:--	<NONE>
7	--:--	--:--	<NONE>
8	--:--	--:--	<NONE>

c. Define The Trigger Type

EXTERNAL CONDITION PROGRAM			
#	From hh:mm	To hh:mm	Start An. Dry Cont.
1		12:00	Ana. Sen 1
2	Ana. Sen 1	12:00	Dry Con 1
3	Ana. Sen 2	13:00	Dry Con 1
4	Ana. Sen 3	--:--	<NONE>
5	Ana. Sen 4	--:--	<NONE>
6	Ana. Sen 5	--:--	<NONE>
7	Ana. Sen 6	--:--	<NONE>
8		--:--	<NONE>

d. Under Stop An. Dry Con.,  
define the input type.

EXTERNAL CONDITION PROGRAM			
#	Trigger Type	Stop An Dry Cont.	Oper. to Start
1	Multi Shot	Ana. Sen 2	---
2	Multi Shot	Dry Con 2	One Shot
3	One Shot	Dry Con 14	Multi Shot
4	One Shot	<NONE>	Only If On
5	One Shot	<NONE>	---
6	One Shot	<NONE>	---
7	One Shot	<NONE>	---
8	One Shot	<NONE>	---

e. Under Oper. to Start, choose  
the required symbol.

EXTERNAL CONDITION PROGRAM			
#	Trigger Type	Stop An Dry Cont.	Oper. to Start
1		Ana. Sen 2	---
2	Ana. Sen 1	Dry Con 2	---
3	Ana. Sen 2	Dry Con 14	---
4	Ana. Sen 3	<NONE>	---
5	Ana. Sen 4	<NONE>	---
6	Ana. Sen 5	<NONE>	---
7	Ana. Sen 6	<NONE>	---
8		<NONE>	---

f. Under Oper. To Stop, choose  
the required symbol.

EXTERNAL CONDITION PROGRAM			
#	Stop An Dry Cont.	Oper. to Start	Start Value
1	Ana. Sen 2	>	
2	Dry Con 2	---	---
3	Dry Con 14	---	<
4	<NONE>	---	<=
5	<NONE>	---	=
6	<NONE>	---	>
7	<NONE>	---	>=
8	<NONE>	---	

EXTERNAL CONDITION PROGRAM			
#	Oper. to Start	Start Value	Oper. to Stop
1		25	=
2	---	---	---
3	<	---	---
4	<=	---	---
5	=	---	---
6	>	---	---
7	>=	---	---
8	---	---	---

g. Under Start Value, enter the required value to start the analog sensor.  
Under Stop Value, entered the required value to stop the analog sensor.

EXTERNAL CONDITION PROGRAM			
#	Start Value	Oper. to Stop	Stop Value
1	25	=	20
2	---	---	---
3	---	---	---
4	---	---	---
5	---	---	---
6	---	---	---
7	---	---	---
8	---	---	---

In the examples given above, irrigation has been set to start when the analog input is greater than 25 and irrigation stops when the input is 20. Oper. to Start and Oper. to Stop require a logical operation. The following table defines these symbols:

Symbol	Definition
---	No operation
<, <=	The analog sensor function value is less than/less than or equal to the start/stop value.
=	The analog sensor function value is equal to the start/stop value. There is a $\pm 1\%$ allowable deviation.
>, >=	The analog sensor function value is greater than/greater than or equal to the start/stop value.

## 12.5 Analog Output

*NOTE* The information here replicates the information found in Section 4.5.6, Analog Output Definition, page 47.

*NOTE* Install analog output cards.

ANALOG OUTPUT			
Channel		Dosing Channel	No.
Local	1	Dosing Channel	1
Local	2	Dosing Channel	2
Local	3	Dosing Channel	3
Local	4	<None>	--
Local	5	<None>	--
Local	6	<None>	--
Local	7	<None>	--
Local	8	<None>	--

This screen enables controlling the dosing channels valves using a 4 - 20 mA current.

- Channel: Read only data listing the analog output channel numbers.
- Dosing Channel: Select dosing channel to enable analog-controlled pumping. When set to None, [Venturi](#) driven injectors control the dosing.
- No.: Map the channel number to the dosing channel.

*NOTE* After defining and mapping the channels, go to [Configuration > Dosing Channel Configuration](#) (page 126).

## 12.6 Hardware Checklist

Same as Hardware Check List screen from TEST section (Menu 6.6).

# 13 Controller Advanced Settings

- Pump Station Configuration, page 143
- Multiple Water Meters, page 143
- Drain Meter Measurement, page 145
- Various Dosing Channel Configurations, page 146
- Dosing Configuration, page 148
- Dual EC/pH Sensors, page 148
- Hot Keys and Status Screens page 150
- Operation Mode, page 151

## 13.1 Pump Station Configuration

**1** Program Manual Alarm History  
Test Setup **Config** Installation

**2** CONFIGURATION  
1. DEVICE DELAY CONFIGURATION  
2. **PUMP STATION CONFIGURATION**  
3. VALVE CONFIGURATION  
4. VALVE FLOW RATE  
5. WATER METER  
6. DOSING CHANNEL CONFIGURATION  
7. DOSING CONFIGURATION  
8. EC PRE-CONTROL CONFIGURATION  
9. DRAINAGE CONFIGURATION  
10. SYSTEM PRESSURE CONFIGURATION

**3** PUMP STATION CONFIGURATION

No.	Capacity m <sup>3</sup> /h	Stability mm:ss	Off Delay mm:ss
1	50.000	--:--	--:--
2	70.000	00:10	00:10
3	80.000	00:15	00:15
4	100.000	--:--	--:--

**4** PUMP STATION CONFIGURATION

No.	Stability mm:ss	Off Delay mm:ss	Station
1	--:--	--:--	YES
2	00:10	00:10	YES
3	00:15	00:15	YES
4	--:--	--:--	NO

**5** CONFIGURATION  
1. DEVICE DELAY CONFIGURATION  
2. PUMP STATION CONFIGURATION  
3. **VALVE CONFIGURATION**  
4. VALVE FLOW RATE  
5. WATER METER  
6. DOSING CHANNEL CONFIGURATION  
7. DOSING CONFIGURATION  
8. EC PRE-CONTROL CONFIGURATION  
9. DRAINAGE CONFIGURATION  
10. SYSTEM PRESSURE CONFIGURATION

**6** VALVE CONFIGURATION

Valve No.	Pump	Main Valve	Water Meter	Drain Meter
1	Pump 4	1	1	--
2	Pump 4	1	--	--
3	Station	2	2	--
4	Station	2	2	--

**3D Diagram:** Pump 1-Capacity 50.000, Pump 2-Capacity 70.000, Pump 3-Capacity 80.000, Pump 4-Capacity 100.000. Valves 1-5 are shown connected to the pumps.

**Graph:** First pump to start will be the biggest, first pump to stop will be the smallest.

Time	Pump 1	Pump 2	Pump 3
00:15	Start	Start	Start
00:10	Stop	Stop	Stop
00:10	Start	Start	Start
00:15	Stop	Stop	Stop

**Valve Allocation:**  
Valves 1 & 2 allocated to Pump 4  
Valves 3, 4 & 5 allocated to station of pumps 1, 2 & 3

## 13.2 Multiple Water Meters

- Option A - Standard Use/Measurement
- Option B - Multiple Water Sources

### 13.2.1 OPTION A - STANDARD USE/MEASUREMENT

**1** Program Manual Alarm History  
Test Setup Conf Installation

**2** CONFIGURATION  
1. DEVICE DELAY CONFIGURATION  
2. PUMP STATION CONFIGURATION  
3. VALVE CONFIGURATION  
4. VALUE FLOW RATE  
5. WATER METER  
6. DOSING CHANNEL CONFIGURATION  
7. DOSING CONFIGURATION  
8. EC PRE-CONTROL CONFIGURATION  
9. DRAINAGE CONFIGURATION  
10. SYSTEM PRESSURE CONFIGURATION

**3** WATER METER

Description	Ratio	Type
Water Meter 1 (L/P)	100.000	STANDARD
Water Meter 2 (L/P)	100.000	STANDARD
Water Meter 3 (L/P)	10.000	STANDARD
Water Meter 4 (L/P)	10.000	STANDARD
Water Meter 5 (L/P)	---	STANDARD
AUX Meter 1 (L/P)	---	---
AUX Meter 2 (L/P)	---	---
AUX Meter 3 (L/P)	---	---
AUX Meter 4 (L/P)	---	---

Enter capacity and type for additional water meters

**4** CONFIGURATION  
1. DEVICE DELAY CONFIGURATION  
2. PUMP STATION CONFIGURATION  
3. VALVE CONFIGURATION  
4. VALUE FLOW RATE  
5. WATER METER  
6. DOSING CHANNEL CONFIGURATION  
7. DOSING CONFIGURATION  
8. EC PRE-CONTROL CONFIGURATION  
9. DRAINAGE CONFIGURATION  
10. SYSTEM PRESSURE CONFIGURATION

**5** VALVE CONFIGURATION

Valve No.	Pump	Main Valve	Water Meter	Drain Meter
1	Pump	1	1	---
2	Pump	1	2	---
3	Pump	1	3	---
4	Pump	1	4	---

Configure meters to valves  
Ex: Valves 3, 4 & 5 are allocated to water meters 2, 3 & 4 consecutively

Only one water meter can be measured at a time.

### 13.2.2 OPTION B - MULTIPLE WATER SOURCES

This option is used for water management, meters are located before the irrigation system.

*NOTE* Cannot allocate a water meter to a valve.

The controller will simulate a virtual water meter with a calculated flow of WM1+WM2+WM3-WM4.

**1** WATER METER

Description	Ratio	Type
Water Meter 1 (L/P)	100.000	STANDARD
Water Meter 2 (L/P)	100.000	STANDARD
Water Meter 3 (L/P)	10.000	STANDARD
Water Meter 4 (L/P)	10.000	STANDARD
Water Meter 5 (L/P)	---	STANDARD
AUX Meter 1 (L/P)	---	---
AUX Meter 2 (L/P)	---	---
AUX Meter 3 (L/P)	---	---
AUX Meter 4 (L/P)	---	---

**2** WATER METER

Description	Type	Sup
Water Meter 1 (L/P)	STANDARD	---
Water Meter 2 (L/P)	STANDARD	---
Water Meter 3 (L/P)	STANDARD	---
Water Meter 4 (L/P)	STANDARD	---
Water Meter 5 (L/P)	STANDARD	---
AUX Meter 1 (L/P)	---	---
AUX Meter 2 (L/P)	---	---
AUX Meter 3 (L/P)	---	---
AUX Meter 4 (L/P)	---	---

Tank 1  
Tank 2  
Water Meter 1  
Water Meter 2  
Water Meter 3  
Water Meter 4  
Water  
Drain Meter

Warning!

### 13.3 Drain Meter Measurement

Use this option for greenhouses drain applications.

**Option A- Total Measurement**

Valve No.	Pump	Main Valve	Water Meter	Drain Meter
1	Pump 1	1	1	1
1	Pump 1	1	1	1
1	Pump 1	1	1	1
1	Pump 1	1	1	1

→

Valve No.	Water Meter	Drain Meter	Drain Type	Sample %
1	1	1	Total	0.0000
1	1	1	Sample	0.0000
1	1	1	Sample	0.0000
1	1	1	Sample	0.0000

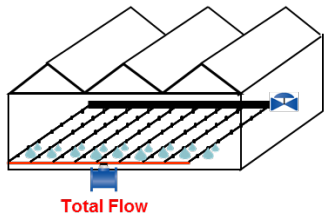

**Option B- Sample Measurement**

Valve No.	Main Valve	Water Meter	Drain Meter	Drain Type
1	1	1	1	Sample
1	1	1	1	Sample
1	1	1	1	Sample
1	1	1	1	Sample

→

Valve No.	Water Meter	Drain Meter	Drain Type	Sample %
1	1	1	Sample	11.1111%
1	1	1	Sample	0.0000
1	1	1	Sample	0.0000
1	1	1	Sample	0.0000

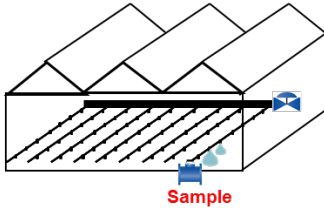

Collect sample from drain of 1 lateral=simulate the total amount of drain water per valve/shift

Meter No.	Ratio Liter/Pulse	On Delay	Off Delay
1	1.000	00:05:00	00:10:00

→

Meter No.	Ratio Liter/Pulse	On Delay	Off Delay
1	1.000	00:05:00	00:10:00

Measure delay:  
On delay= time it takes for water to get through the system.  
Off Delay= time after irrigation it takes for water to fully drain and stop drain measurement.

#### 13.3.1 DRAINAGE TIMING OPTION A

Use this option when irrigating one valve is which allocated to a drain meter.

Meter No.	Ratio Liter/Pulse	On Delay	Off Delay
1	1.000	00:05:00	00:10:00

→

Valve No.	Main Valve	Water Meter	Drain Meter	Drain Type
1	1	1	1	Total
1	1	1	1	Sample
1	1	1	1	Sample

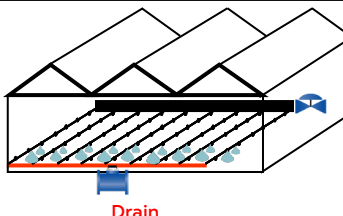
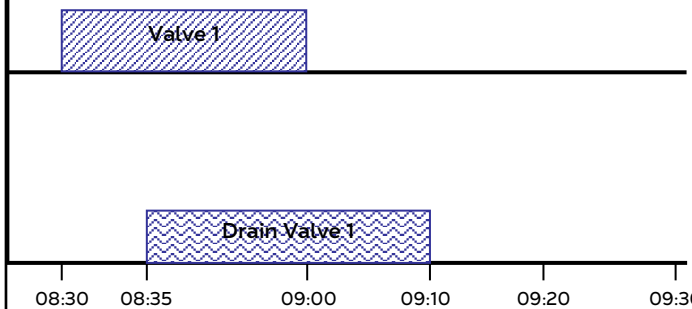



### 13.3.2 DRAINAGE TIMING OPTION B

Use this option when irrigating two consecutive valves which allocated to the same drain meter.

Meter No.	Ratio Liter/Pulse	On Delay	Off Delay
1	1.800	00:05:00	00:10:00

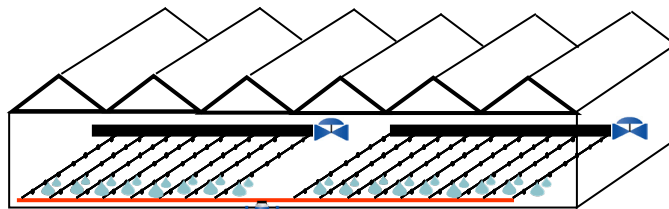
Valve No.	Main Valve	Water Meter	Drain Meter	Drain Type
1	-	-	-	Total
2	-	-	-	Sample



Drain meter 1

NOTE : Valve 2 "On Delay" is taking control of valve 1 "Off Delay". Means that valve 1 drain measurement finished while valve 2 drain measurement just

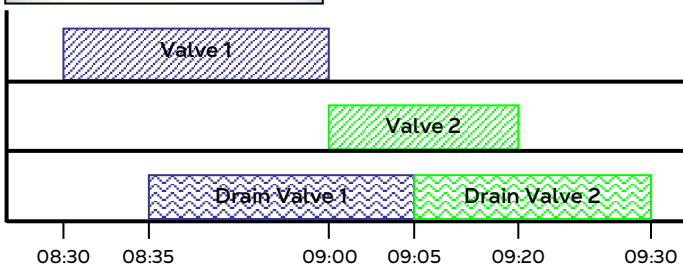

### DRAIN LOG



History Menu



Date	Time	U1	Drain %	Drain
08:30:00	08:30:00	100.00	100.00	180.00
08:35:00	08:35:00	100.00	100.00	180.00
08:40:00	08:40:00	100.00	100.00	180.00
08:45:00	08:45:00	100.00	100.00	180.00
08:50:00	08:50:00	100.00	100.00	180.00
08:55:00	08:55:00	100.00	100.00	180.00
09:00:00	09:00:00	100.00	100.00	180.00
09:05:00	09:05:00	100.00	100.00	180.00
09:10:00	09:10:00	100.00	100.00	180.00
09:15:00	09:15:00	100.00	100.00	180.00
09:20:00	09:20:00	100.00	100.00	180.00
09:25:00	09:25:00	100.00	100.00	180.00
09:30:00	09:30:00	100.00	100.00	180.00

View drainage history log:

1st column - drain percentages of total  
2nd column - real drain amount (liter or

### 13.4 Various Dosing Channel Configurations

- Method 1
- Method 2
- Method 3

#### 13.4.1 METHOD 1

- Dosing Pump control = Calculated according to Nominal Flow Rate
- Dosing pump measurement = Calculated according to Fert. Meter
- Dosing pump type = Venturi or Electric



Inject fertilizer according to nominal capacity of pump/measure from fertilizer meter for verification purposes

Set nominal pump capacity

Set dosing meter ratio W/P of dosing meter, = volume per pulse in liter (L) or gallon (G)

Set alarm when the difference between the nominal dosing flow and the measured dosing flow is ±xx% (default set at recommended 25%)

Alarm Menu

### 13.4.2 METHOD 2

- Dosing Pump control = Calculated according to Nominal Flow Rate
- Dosing pump measurement = Calculated according to dosing pump flow rate
- Dosing pump type = Venturi or Electric

### 13.4.3 METHOD 3

- Dosing Pump control = According Fert. meter pulses (For quantitative injection only)
- Dosing pump measurement = Fert. Meter
- Dosing pump type = Hydraulic

### 13.5 Dosing Configuration



Type of each channel configured by technician during installation

- EC- channel influenced by EC levels
- ACID- channel to inject acid to reduce pH levels
- PASSIVE- no EC/pH influence
- ALKALI- channel to increase pH levels

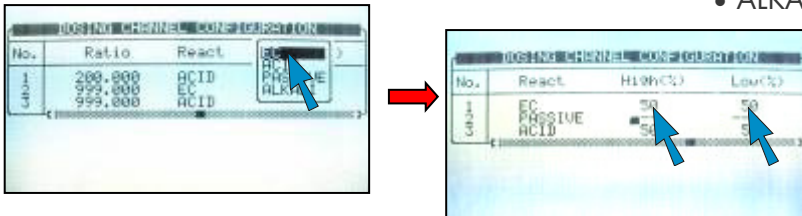

DOSING CONFIGURATION	
EC Coarse Tuning	5
EC Fine Tuning	5
pH Coarse Tuning	5
pH Fine Tuning	5
Control Cycle EC	4
Control Cycle pH	4
EC/pH Averaging (0-Low, 20-High)	3
Dosing Boost Off Delay (mm:ss)	00:02
Dosing by QTY. Method	SPREAD

- EC/pH coarse tuning- when way off target, faster/stronger correction
- EC/pH fine tuning- off target is low, slow/light correction
- EC/pH Control cycle- Delay time from fertilizer/Acid injection point to EC/pH sensors reading
- EC/pH averaging- balanced reading from EC/pH sensors

### 13.6 Dual EC/pH Sensors

Additional sensors as fail-safe and to verify if difference occurs; alarms signal.

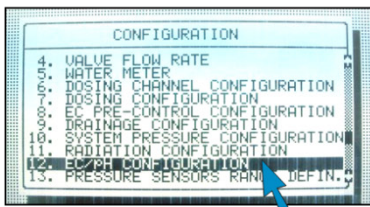
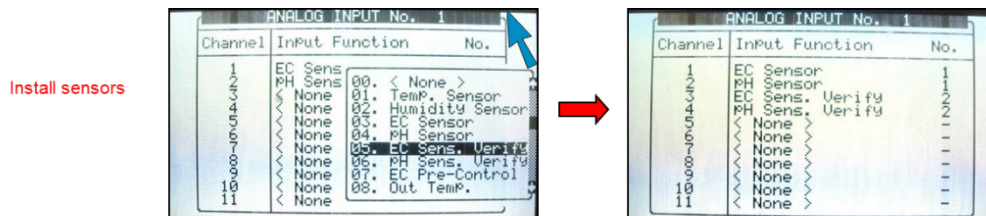

Sensor	4 mA	20 mA	Sensor Dif.
EC 1	0	10	
EC 2	0	14	
pH 1	0	14	
pH 2	0	20	

EC Control Sensor      EC 1+EC 2  
 pH Control Sensor      pH 1+pH 2

Enter sensor difference to set alarm

Sensor	4 mA	20 mA	Sensor Dif.
EC 1	0	10	
EC 2	0	14	0.50
pH 1	0	14	
pH 2	0	20	0.50

EC Control Sensor      EC 1+EC 2  
 pH Control Sensor      pH 1+pH 2

Select action and delay- if 1 sensor fails, sensor 2 activated

At end, if one sensor fails, the technician can set the system to be controlled by the 2<sup>nd</sup> sensor



Description	Irri. Dose	Delay mm:ss	Alarm Active
EC High/Fail	STOP	STOP	01:00 VE
EC Low	STOP	STOP	01:00 VNS
pH High	STOP	STOP	01:00 VNS
pH Low/Fail	STOP	STOP	01:00 VNS
EC-Hi/Fail	STOP	STOP	01:00 VNS
EC-Pre. Low	STOP	STOP	01:00 VNS
Tank Fresh	STOP	STOP	01:00 VNS
Tank Drain	STOP	STOP	01:00 VNS
EC Sen. Dif.	STOP	STOP	01:00 VNS
pH Sen. Dif.	STOP	STOP	01:00 VNS

Sensor	4 mA	20 mA	Sensor Dif.
EC 1	0	10	
pH 1	0	14	
EC 2	0	14	
pH 2	0	20	

EC Control Sensor      EC 2  
 pH Control Sensor      pH 1+pH 2

- DUAL EC/pH SENSORS- Additional sensors as fail-safe and to verify if difference occurs, alarm will signal.

**End day time**

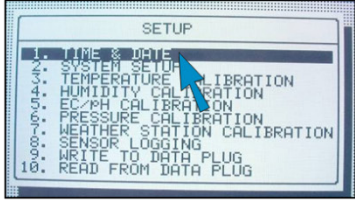
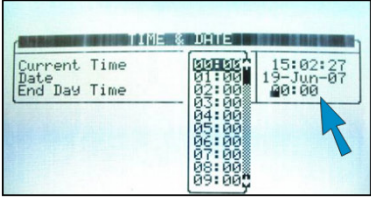

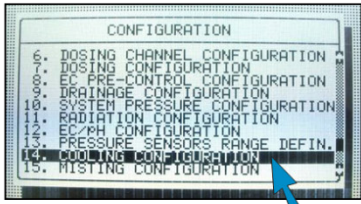

Stop time for measuring water and dosing accumulating information from irrigation valves and dosing channels

**Max. cooling parallel**



**Max. misting parallel**



Define cooling/misting valve/pump

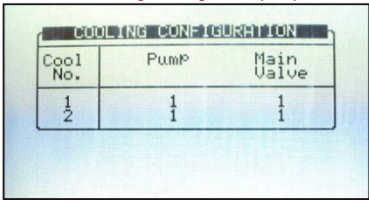

Cool No.	Pump	Main Valve
1	1	1
2	1	1

**SYSTEM SETUP**

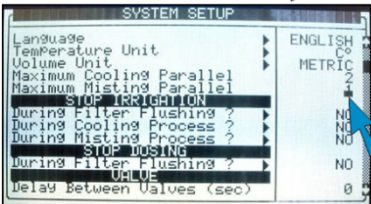

Set max. cooling/misting programs working together

**NOTE:** Operate max # cooling/misting programs according to system water pressure limit.

**Stop irrigation?**

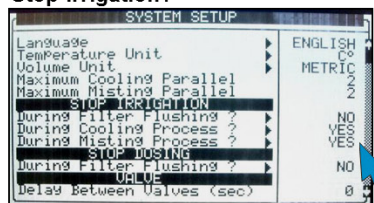

Set to pause irrigation during cooling/misting process, then resume irrigation

**Stop Dosing?**

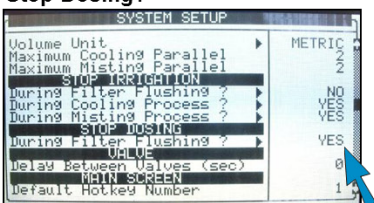

Set to pause dosing during filter flushing process, then resume irrigation

**Valve transition**

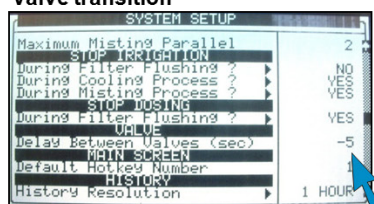

5 second overlap

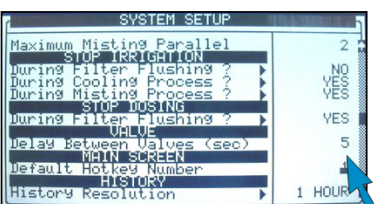

5 second delay

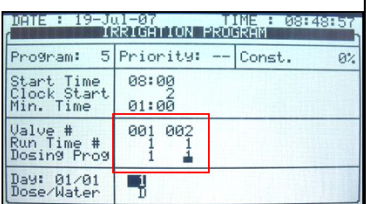

Set delay between valves or set to overlap valves in order to create pressure before opening them by pressing +/- key

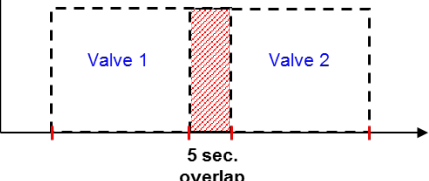
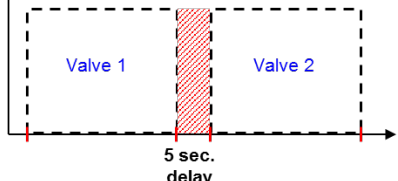

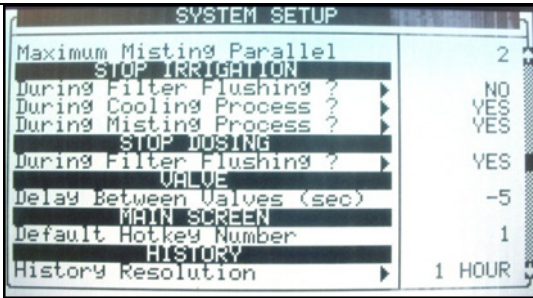

### Default hot key/ History resolution

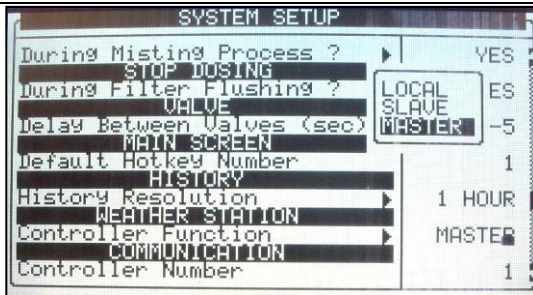

- Change setting of default hot key that will be present for the grower as a default.
- Set history resolution-how often system saves information

### Weather station



- Local - Only one controller network
- Master - connected to station, transfers data to slave controller
- Slave - more than 1 controller network, not connected to station but receive data by communication to the Master

### Baud rate

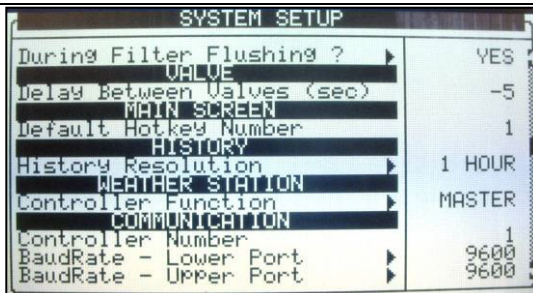

- Select baud rate of communication:
- Lower Port - Controllers and PC
- Upper Port - Controller and its expansion boxes/Remote unit (SingleNet)

## 13.7 Hot Keys and Status Screens

In the Active Irrigation screen, view the status of the system by pressing number keys corresponding to each hot key.

### Hot Screen 1- Active Irrigation

ACTIVE IRRIGATION			
	SET	ACTUAL	LEFT
CYCLE	1	1	0
WATER	00:10:00	00:00:09	00:09:52
FLOW	100.000	100.000	
EC	not set	1.5	
PH	not set	5.3	
PROGRAM: MANUAL		14:12:02	ACTIVE
VALVE: 1		14-Mar-07	IRRIGATION
MESSAGE			DOSING
			ALARM

### Hot Screen 2- Irrigation Process Status

IRRIGATION PROCESS				
Prog:Un. irr Valve: 1 Time: 16:43:49				
	Set	Actual	Flow	Valve
Water	00:10	00:00	0.000	ON
Chan. 1	5.00	0.00	----	OFF
Chan. 2	5.00	0.00	999.000	OFF
Chan. 3	3.00	0.00	999.000	OFF

Hot Screen 3- Program Status

PROGRAM STATUS	
Program: 1	18-Oct-07 16:43:58
Status	End 20:00
Time - Minimum	---
Time - Maximum	---
Rad Sum - Measured/Limit	---/---
Clock Starts - Given/Set	0/0
Starts Due To Rad Sum	---
Starts Due To Max Time	---
Total Cycles Given	0
Last Start	---
Elapsed Time	00:03:12
Next Start	---

Hot Screen 4- Water Flow & EC/pH Status

WATER FLOW		EC/pH		
Status Irrig.	EC	pH	EC.Pre	
Nom. 100.000	Trg. 1.5	5.5		
Act. 0.000	Act. ---	---		
	Open(%)	Min(%)	Prg(%)	Max(%)
Chan. 1	---	---	---	---
Chan. 2	---	---	---	---
Chan. 3	---	---	---	---

Hot Screen 5- Filter Flushing Status

FILTER FLUSHING STATUS	
Item	
Flush Status	OFF
Time To Next Flush	01:02:52
Delta Pressure (Digital)	OFF
Flushing Filter No.	---
Remaining Filters Qty.	0
Delay	00:05
Current Delta Pressure	---
Main Filter Delay	00:00:10

Hot Screen 6- Temp. & Hum. Status

TEMP & HUMIDITY		
No.	Temp.	Humidity
1	23.1	58.0
2	<NONE>	<NONE>
3	<NONE>	<NONE>
4	<NONE>	<NONE>
5	<NONE>	<NONE>
6	<NONE>	<NONE>
7	<NONE>	<NONE>
8	<NONE>	<NONE>
AVG.	23.1	58.0

Hot Screen 7- Weather Station Status

WEATHER STATION	
Outside Temperature	<NONE>
Outside Humidity	<NONE>
Wind Direction	<NONE>
Wind Speed	0.0 Km/h
Radiation	<NONE>
Radiation Sum	<NONE>
Rain Status	<NONE>
Rain Flow	<NONE>
Daily Rain	<NONE>

Hot Screen 8- System Pressure Status

SYSTEM PRESSURE	
Sensor	Value
Pressure In	N/A
Pressure Out	N/A

\*The Highlighted Sensor Is The System Pressure

## 13.8 Operation Mode

There are three levels of operation:

- **Read Only (restricted):** All the parameters and menus are visible, but cannot be modified
- **User (partially restricted):** Menus 1-6 are fully accessible and can be modified. Menus 7 and 8 can be viewed but not modified
- **Technician (unrestricted):** All menus are fully accessible (no restrictions)

To change the operation mode, select Mode.

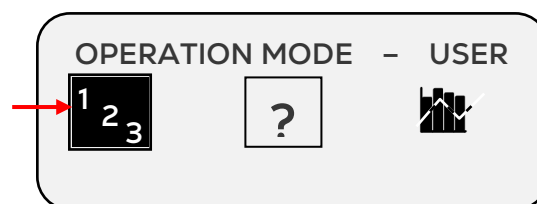

On the Front Panel, press Zone/Log In.

The controller recognizes the operation mode according to the password that is entered:

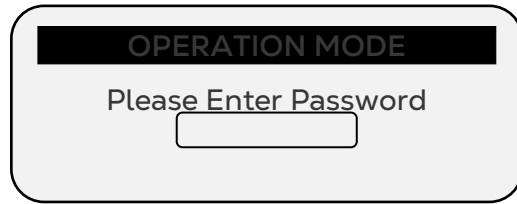

MODE	PASSWORD
Read Only	0000
User	9999
Technician	1948

If an incorrect password is entered, then this screen will appear:

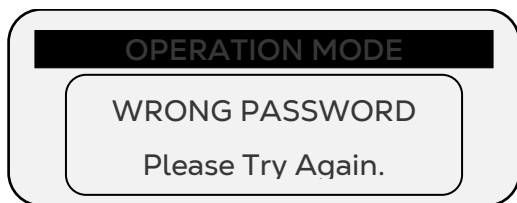

The Operation mode can be configured to automatically return to the “Read-Only” mode after a certain amount of time.

*NOTE Refer to the 10.2 System Setup section.*

A screenshot of the 'SYSTEM SETUP' menu. The menu is divided into sections: HISTORY, WEATHER STATION, OPERATION MODE, and COMMUNICATION. Two red arrows point to the 'OPERATION MODE' section.

SYSTEM SETUP	
<b>HISTORY</b>	
History Resolution ▶	1 HOUR
<b>WEATHER STATION</b>	
Controller Function ▶	LOCAL
<b>OPERATION MODE</b>	
Automatic return to RO mode ▶	NO
Return period to RO mode ▶	00:10
<b>COMMUNICATION</b>	
Controller Number ▶	1
Lower Port – Protocol ▶	GREEN NET
Lower Port – Baudrate ▶	9600
Upper Port – Protocol ▶	NONE
Upper Port – BaudRate ▶	9600

- To perform a cold start or firmware upgrade, the controller must be in the “Technician” mode.

If there is a power failure, the controller will power up with the last mode that used.

# 14 Appendix A – GreenField Parts List

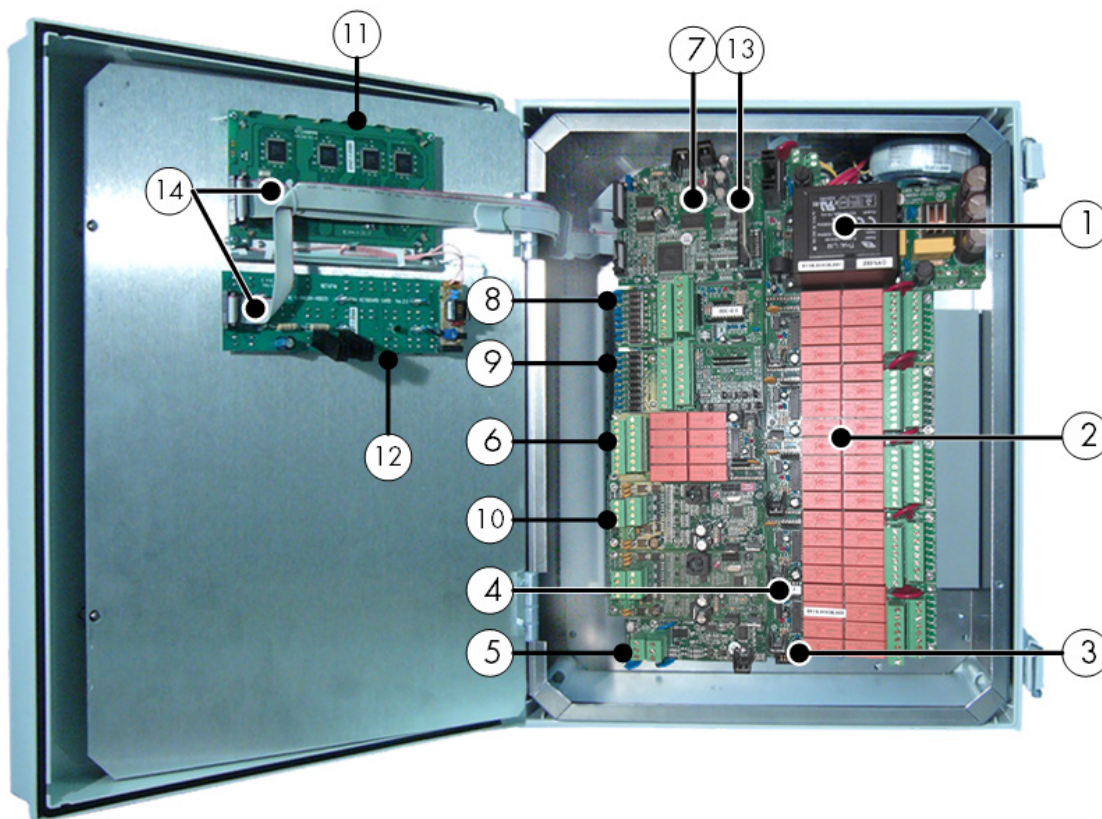

Item #	Description	Part #
1	GreenField/Climate Power supply card 115VAC	960-99-00041
	GreenField/Climate Power supply card 230VAC	960-99-00011
2	GreenField/Climate 24VAC output cards, 8 outputs	960-99-00002
3	GreenField Memory backup key – Data Plug	960-99-00034
4	GreenField/Climate Input/Output BUS card	960-99-00012
5	GreenField/Climate Communication card RS-485	960-99-00006
6	GreenField/Climate Dry Contact output card, 8 outputs	960-99-00003
	GreenField/Climate Analog Input Card, 11 inputs	960-99-00005
7	Green Climate Cont. Arm CPU Card	960-99-00010
	GreenField Cont. Arm CPU Card	960-99-00042
8	GreenField/Climate Digital Input Card, 8 inputs	960-99-00004
9	GreenField/Climate Analog Input Card, 11 inputs	960-99-00005
10	GreenField Analog Output Card, 4 outputs	960-99-00037
11	GreenField Display card with LED backlit (new type)	960-99-00033
12	GreenField/Climate Keyboard card	960-99-00013

Item #	Description	Part #
13	GreenField /Climate SD card	960-99-00035
14	Greenfield - Flat Set NMCPR Two Flats With Ferrite	960-99-00125



# 15 Appendix B – Troubleshooting

- Controller Malfunction
- Burnt Fuse - In Case of Voltage

## 15.1 Controller Malfunction

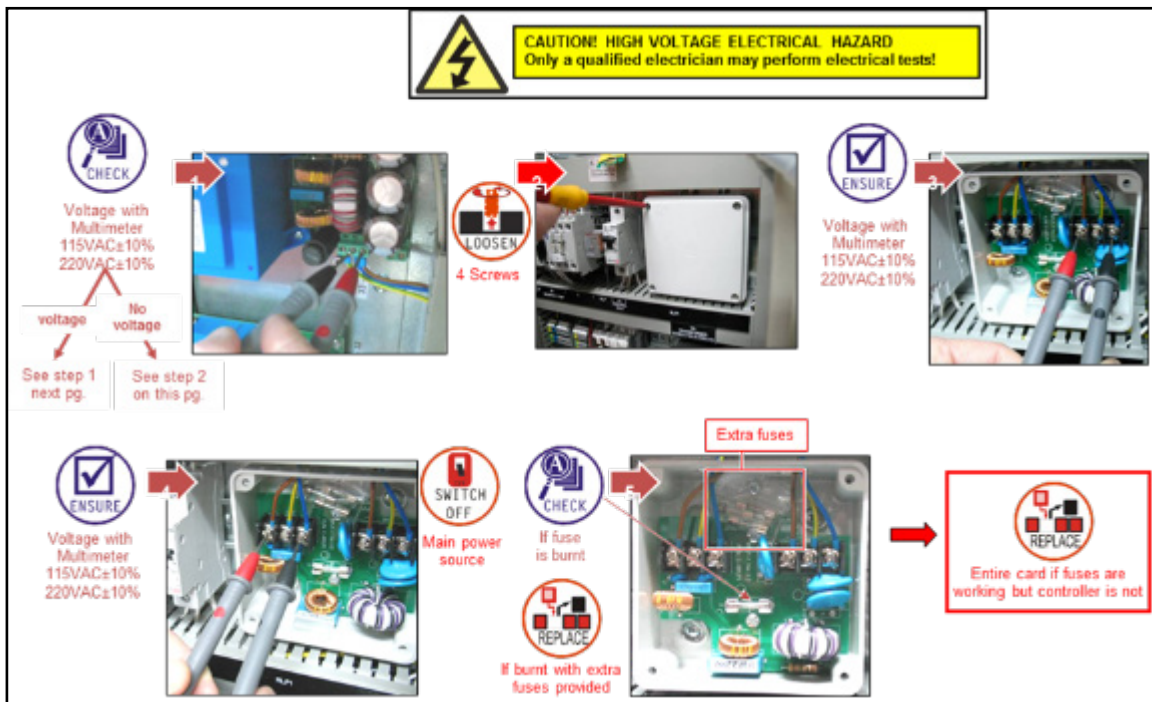

## 15.2 Burnt Fuse - In Case of Voltage

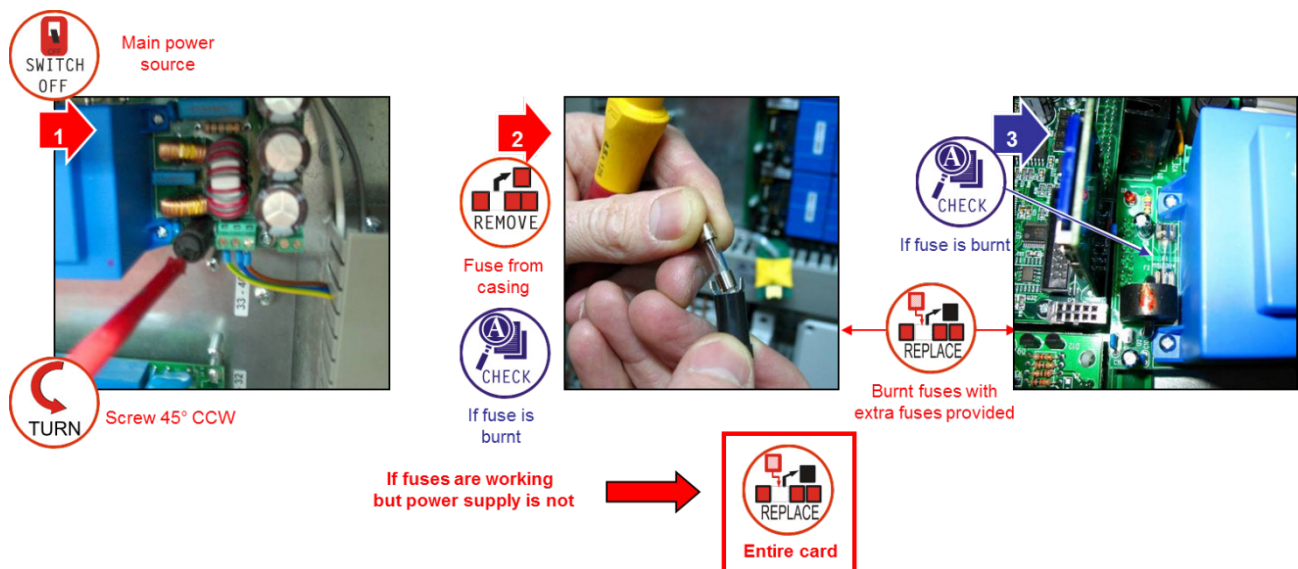

# 16 Appendix C – Replacements and Additional Installations

- Installing a 24 VAC Output Card, page 156
- Removing a Card, page 157
- Adding a Dry Contact Output Card, page 157
- Adding an Input Card, page 158
- LCD & Keyboard Replacement, page 159

## 16.1 Installing a 24 VAC Output Card

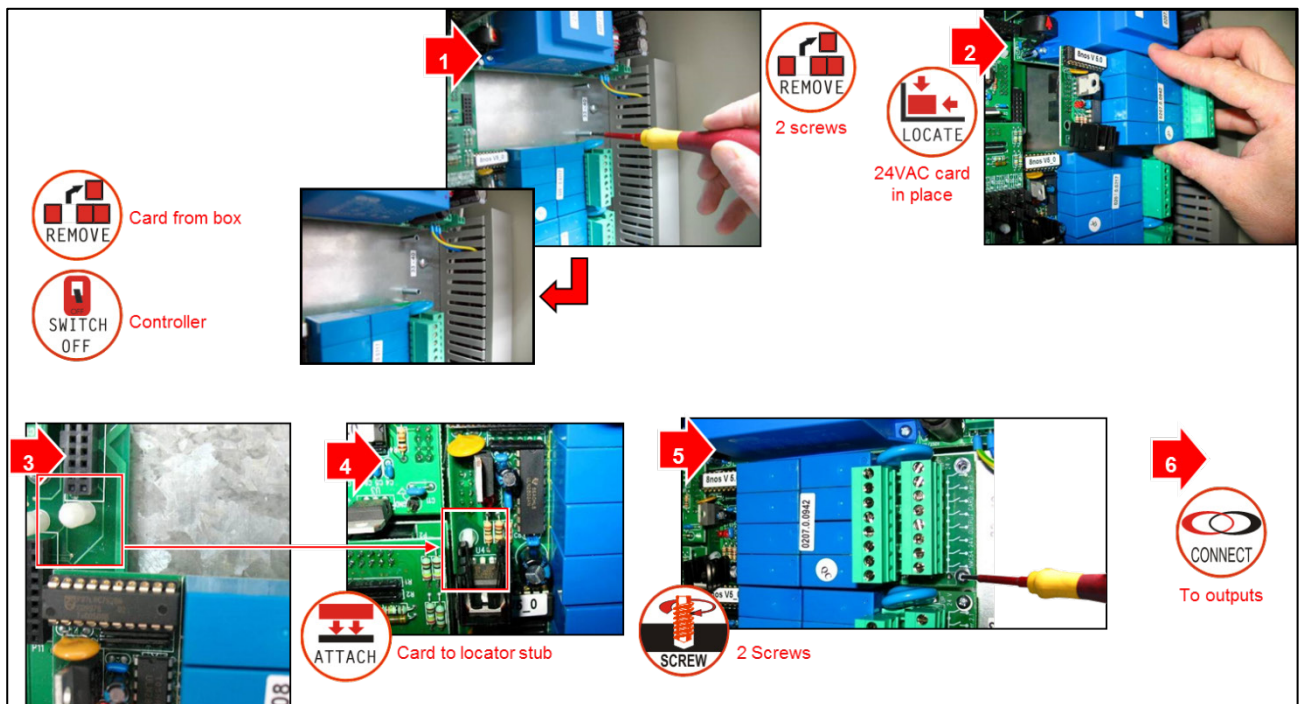

## 16.2 Removing a Card

*NOTE The procedure is the same for all cards.*

1 SWITCH OFF Controller

2 REMOVE Wires 2 Screws

3 PERFORM Use pliers to squeeze stub back through hole and gently manipulate card forward to remove

TOOLS Pliers

## 16.3 Adding a Dry Contact Output Card

1 SWITCH OFF Controller REMOVE 2 screws

2 LOCATE CONNECT Dry Contact card in place Low terminal to power supply and high terminal to outputs ATTACH Card as above

3 SWITCH ON Controller

4 NEW OUTPUT CARD FOUND! DO YOU WANT TO INSTALL IT? YES NO

## 16.4 Adding an Input Card

**1** REMOVE Card from box

**2** ATTACH Standoffs to back of card

REMOVE Standoffs and screws from back wall

SWITCH OFF Controller

**3** ATTACH Digital Input card as above

**4** LOCATE Stub

**5** ATTACH Jumper to terminal 2

**6** SCREW 2 Screws

**7** ATTACH Jumper to terminal 2

**8** SWITCH ON Controller

**9** NEW INPUT CARD FOUND!  
DO YOU WANT TO INSTALL IT?  
YES NO

Note: Analog Input card installed in same way without jumper.

## 16.5 LCD & Keyboard Replacement

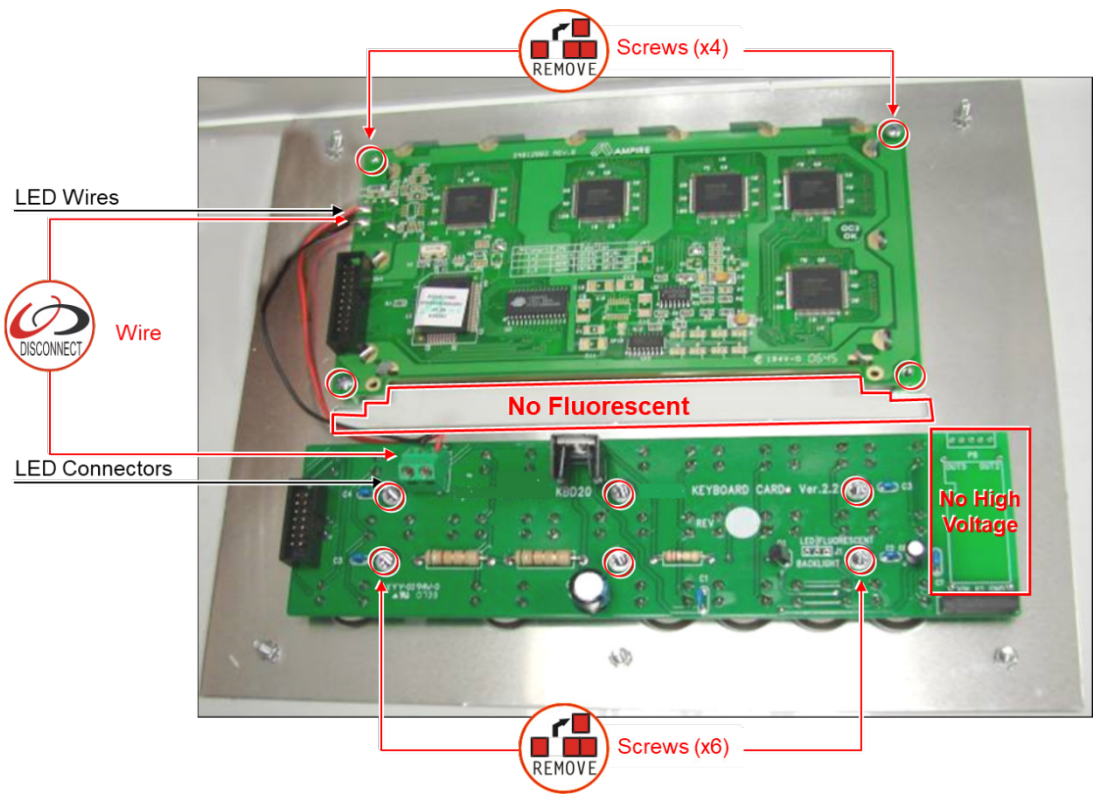

# 17 Appendix D - Sensor Installation and Definition

- EC – pH Sensor Connection, page 160
- Measuring Box Connection, page 165
- Humidity Sensor Definition, page 166
- Pyranometer Connection – GreenField, page 168
- Radiation Sensor Definition, page 169
- Pressure Transducer Connection, page 172
- Wind Direction Connection, page 173
- Sensor and Cable Specifications, page 175

## 17.1 EC – pH Sensor Connection

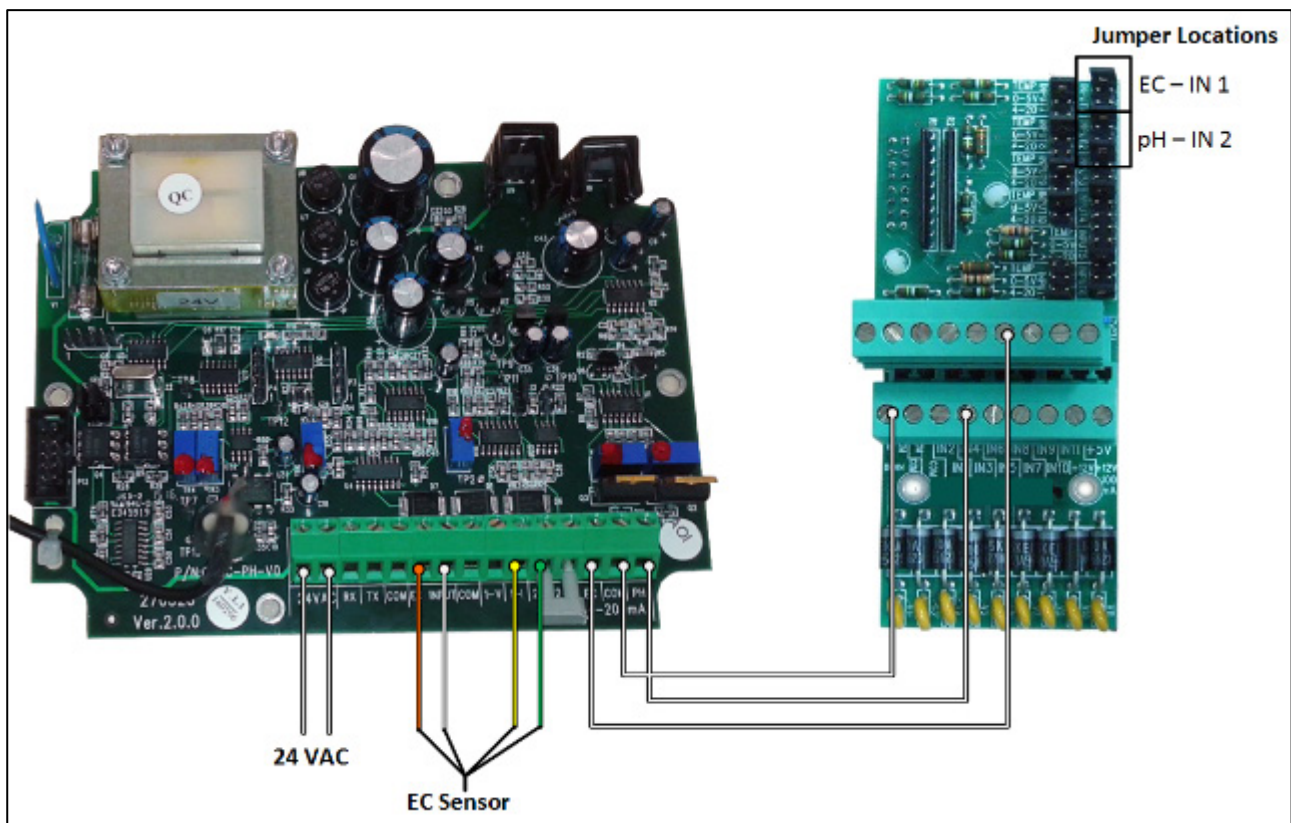

Jumper Position	Sensor type
Temp	Temperature sensor (30 ohm)
0 – 5V	Humidity, Radiation, Pressure
4 – 20 mA	EC, pH

- EC Sensor Calibration, page 161

- pH Sensor Calibration, page 162
- GreenField pH Calibration, page 164

### 17.1.1 EC SENSOR CALIBRATION

*NOTE Perform the following procedure in one continual session. Interruptions or delays while performing the procedure can cause calibration failure.*

1. On EC/pH screen press .



EC Calibration appears.



2. Press . Calib 1.4 appears.



3. Press .



4. Clean and dry an EC sensor. Insert the sensor into 1.4mS calibration buffer;

immerse for 5 – 7 seconds and immediately press .



Calibration is in process.



*NOTE Perform the following step as soon as the EC 0 screen appears.*

5. When the following screen appears, remove the sensor from the buffer and hold it

in the air; press .

To EC 0 - Enter

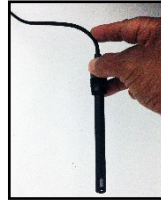

6. Calibration is in process; wait until next screen is displayed, which indicates that EC Calibration is complete.

EC: 0.0 Cal:0.0

7. Wait until the following screen appears.

Calibration OK

EC calibration is complete.

### 17.1.2 PH SENSOR CALIBRATION

*NOTE Perform the following procedure in one continual session. Interruptions or delays while performing the procedure can cause calibration failure.*

1. On EC/pH screen, press



EC calibration appears.

EC Calibration

pH Calibration

2. Press



to scroll down to pH CALIBRATION.

3. Press



To pH 7.0 Enter

*NOTE Perform the following step as soon as the EC 7.0 screen appears.*

4. Verify that the pH sensor is dry; insert it into a pH 7 calibration buffer, immerse for 5

- 7 seconds and press







The following screen appears.

pH: 6.9 Cal:7.0

5. Calibration is in process, wait until the following screen appears.

To pH 4 - Enter

*NOTE Perform the following step immediately upon appearance of the pH 4 screen.*

6. Verify that the pH sensor is dry; insert it into pH 4 calibration buffer, immerse for 5

- 7 seconds and press



The following screen appears.

pH: 3.3 Cal:4.0

7. Wait until the following screen appears.

Calibration OK

pH calibration is complete.

*NOTE If display says "BUFFER FAULT" please refer to Troubleshooting in the EC pH Manual.*

### 17.1.3 GREENFIELD PH CALIBRATION

**SELECT**

In Setup select EC/pH Calibration

**Munters**

GREENECPH

EC: 1.6 pH: 6.1

**SETUP**

1. TIME & DATE
2. SYSTEM SETUP
3. TEMPERATURE CALIBRATION
4. HUMIDITY CALIBRATION
5. EC/pH CALIBRATION
6. PRESSURE CALIBRATION
7. WEATHER STATION CALIBRATION
8. SENSOR LOGGING
9. WRITE TO DATA PLUG
0. READ FROM DATA PLUG

**EC/pH CALIBRATION**

Sensor	Value	Factor
EC	1.60	0.00
pH	6.00	-0.36
TEMP	<NONE>	---
PH	<NONE>	---

Press (-) Arrow to Increase/Decrease

**EC CALIBRATION**

Sensor	Value	Factor
EC	1.60	0.00
pH	6.00	-0.36
TEMP	<NONE>	---
PH	<NONE>	---

Press (-) Arrow to Increase/Decrease

**pH CALIBRATION**

Sensor	Value	Factor
EC	1.60	0.00
pH	6.00	-0.36
TEMP	<NONE>	---
PH	<NONE>	---

Press (-) Arrow to Increase/Decrease

Save Changes?

**YES** NO

**CHECK**

IF EC and pH numbers match on both

Use arrows to increase/decrease value so numbers match

- ENTER when values match
- Press Menu

## 17.2 Measuring Box Connection

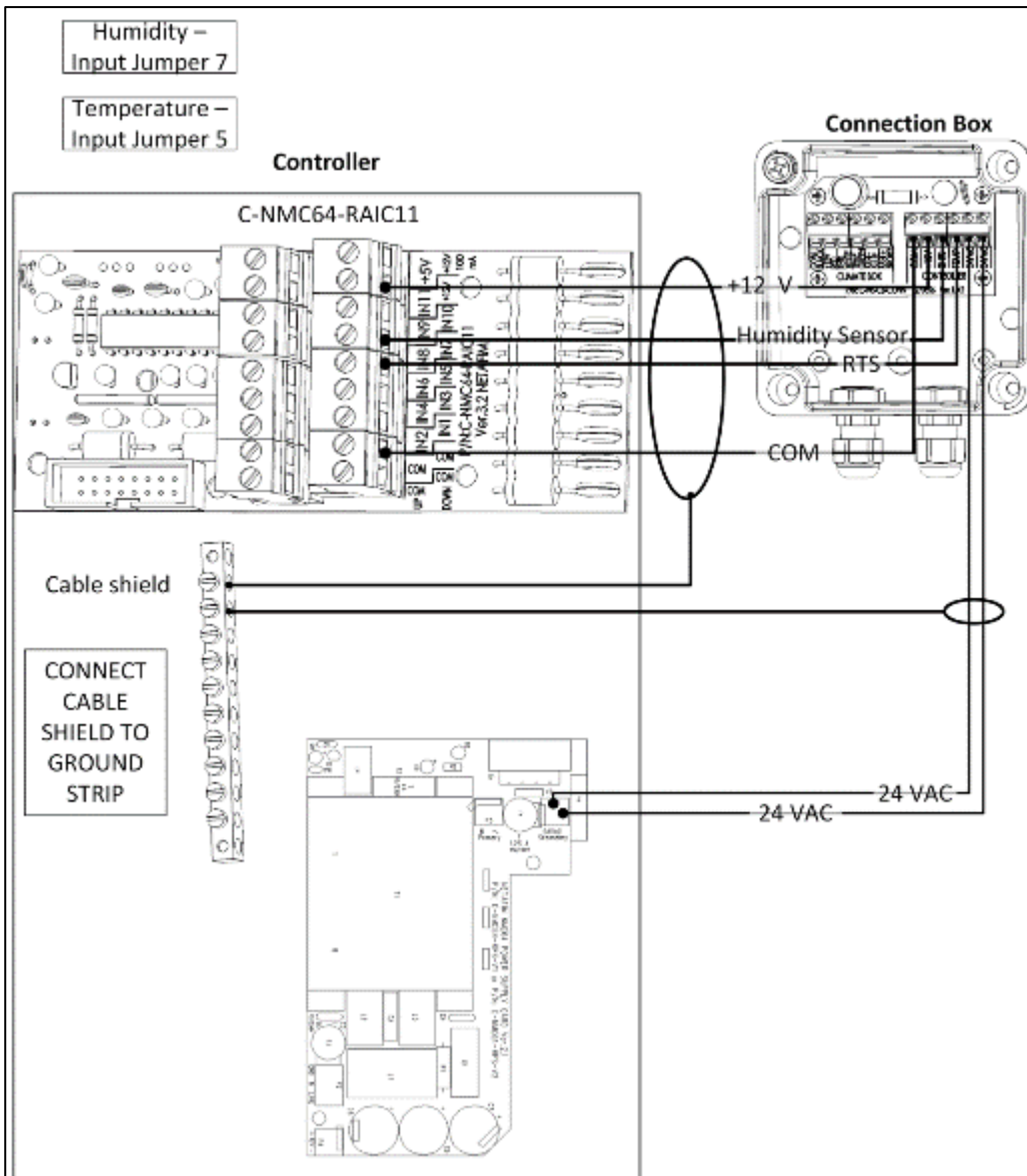

**NOTE** Can wire 24 VAC terminals of measuring box to 24 VAC on the output terminals.

Jumper positioning	Sensor type
Temp	Temperature Sensor (30 kOhm)
0 - 5 V	Humidity
4 - 20 mA	EC, pH, CO <sub>2</sub>

**CAUTION** TO ENSURE INTERFERENCE AND LIGHTNING IMMUNITY, USE SHIELDED CABLE ONLY (22 AWG MINIMUM)!

**CAUTION** POWER AND SIGNAL WIRES MUST BE IN SEPARATE CABLES!

### 17.3 Humidity Sensor Definition

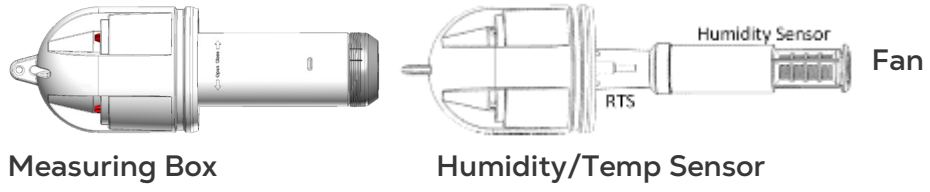

INSTALLATION	
1.	DEVICE LAYOUT
2.	DEVICE LIST
3.	DIGITAL INPUT 1
4.	DIGITAL INPUT 2
5.	<b>ANALOG INPUT 1</b>
6.	ANALOG INPUT 2
7.	HARDWARE CHECKLIST

ANALOG INPUT 1		
Channel	Input Function	No.
1	EC Sensor	00. <None>
2	pH Sensor	01. Temp Sensor
3	< None	02. Humidity Sensor
4	< None	03. EC Sensor
5	< None	04. pH Sensor
6	< None	05. EC Sens. Verify

ANALOG INPUT 1		
Channel	Input Function	No.
1	EC Sensor	1
2	pH Sensor	1
3	Temp Sensor	1
4	< None	-
5	< None	-
6	< None	-

ANALOG INPUT 1		
Channel	Input Function	No.
1	EC Sensor	00. <None>
2	pH Sensor	01. Temp Sensor
3	Temp Sensor	02. Humidity Sensor
4	< None	03. EC Sensor
5	< None	04. pH Sensor
6	< None	05. EC Sens. Verify

ANALOG INPUT 1		
Channel	Input Function	No.
1	EC Sensor	1
2	pH Sensor	1
3	Temp Sensor	1
4	Humidity Sensor	-
5	< None	-
6	< None	-

- Outside Temperature/Humidity Sensor Connection
- Sensor Definition

### 17.3.1 OUTSIDE TEMPERATURE/HUMIDITY SENSOR CONNECTION

Jumper positioning	Sensor type
Temp	Temperature sensor (30kΩ)
0-5V	Humidity
4-20mA	EC, pH, CO2...



**Cable type**  
4x0.5mm<sup>2</sup> (20AWG)

**Sensor Wires**  
Temp&Hum sensor: Black - COM  
Hum sensor: White - Input  
Temp sensor: Red - Input  
Hum sensor: Red - +12VDC

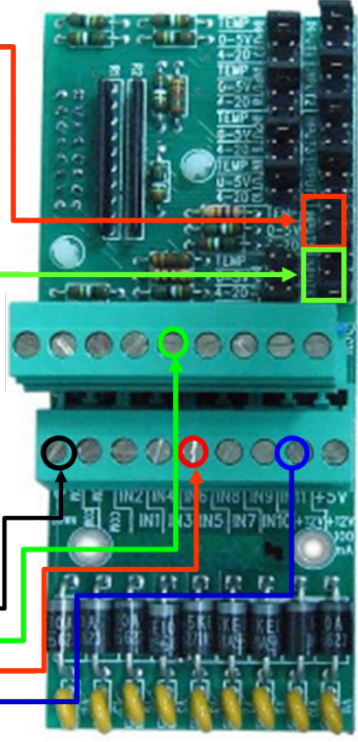

### 17.3.2 SENSOR DEFINITION

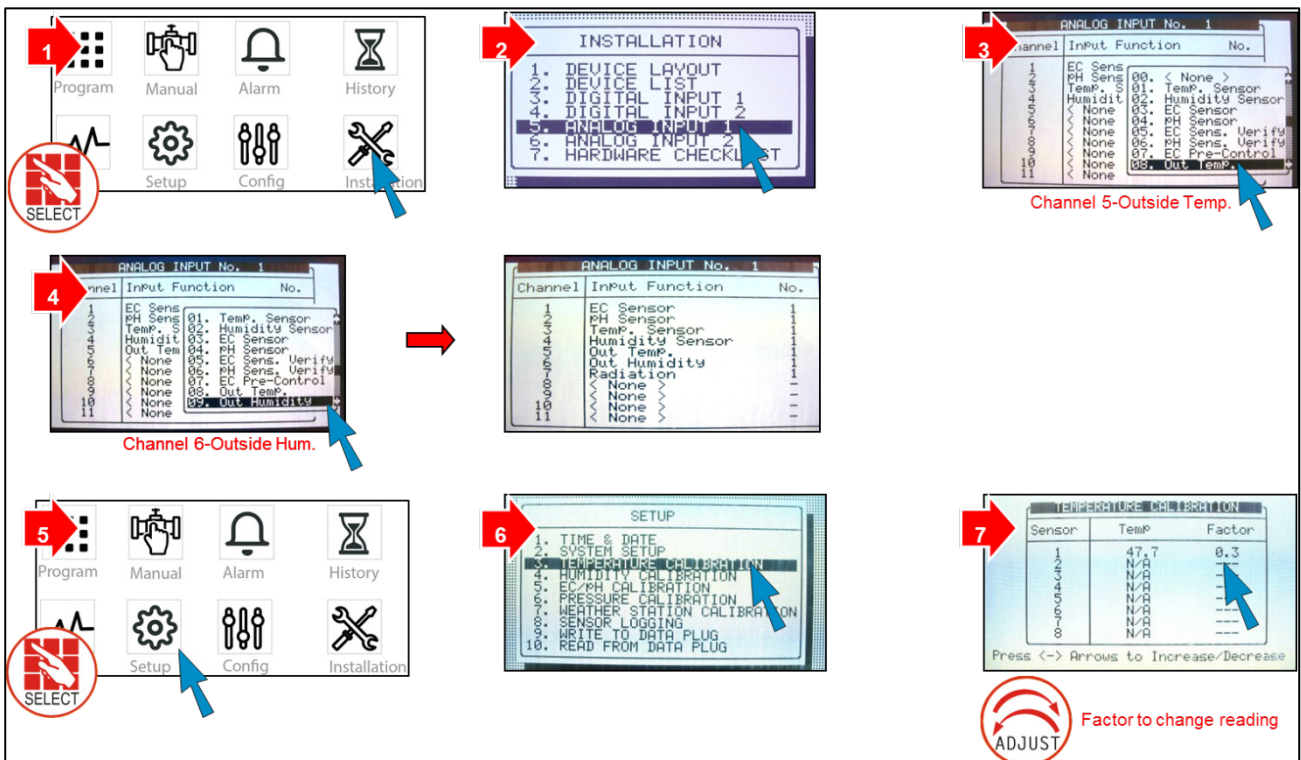

**1** Program Manual Alarm History

**2** INSTALLATION  
1. DEVICE LAYOUT  
2. DEVICE LIST  
3. DIGITAL INPUT 1  
4. DIGITAL INPUT 2  
5. ANALOG INPUT 1  
6. ANALOG INPUT 2  
7. HARDWARE CHECKLIST

**3** ANALOG INPUT No. 1  
Channel Input Function No.  
1 EC Sens 00 < None >  
2 PH Sens 01 Temp. Sensor  
3 Temp. 02 Humidity Sensor  
4 Humidit 03 EC Sensor  
5 None 04 PH Sensor  
6 None 05 EC Sens. Verify  
7 None 06 PH Sens. Verify  
8 None 07 EC Pre-Control  
9 None 08 Out Temp

Channel 5-Outside Temp.

**4** ANALOG INPUT No. 1  
Channel Input Function No.  
1 EC Sensor 01  
2 PH Sensor 02  
3 Temp. Sensor 03  
4 Humidity Sensor 04  
5 Out Temp. 05  
6 Out Humidity 06  
7 Radiation 07  
8 None 08  
9 None 09  
10 None 10  
11 None 11

Channel 6-Outside Hum.

**5** Program Manual Alarm History

**6** SETUP  
1. TIME & DATE  
2. SYSTEM SETUP  
3. TEMPERATURE CALIBRATION  
4. HUMIDITY CALIBRATION  
5. EC/pH CALIBRATION  
6. PRESSURE CALIBRATION  
7. WEATHER STATION CALIBRATION  
8. SENSOR LOGGING  
9. WRITE TO DATA PLUG  
10. READ FROM DATA PLUG

**7** TEMPERATURE CALIBRATION  
Sensor Temp Factor  
1 47.7 0.3  
2 N/A  
3 N/A  
4 N/A  
5 N/A  
6 N/A  
7 N/A  
8 N/A

Press (<-) Arrows to Increase/Decrease

Factor to change reading

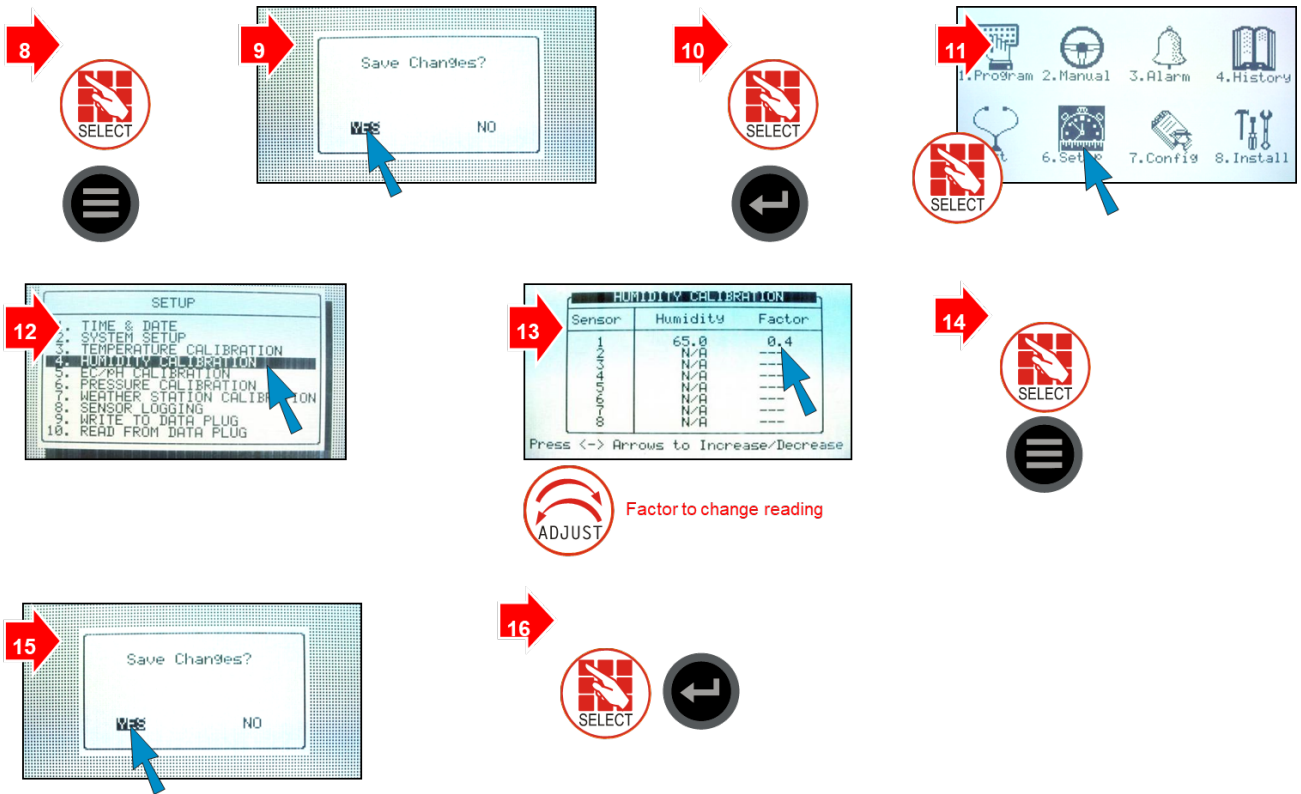

ADJUST Factor to change reading

### 17.4 Pyranometer Connection – GreenField

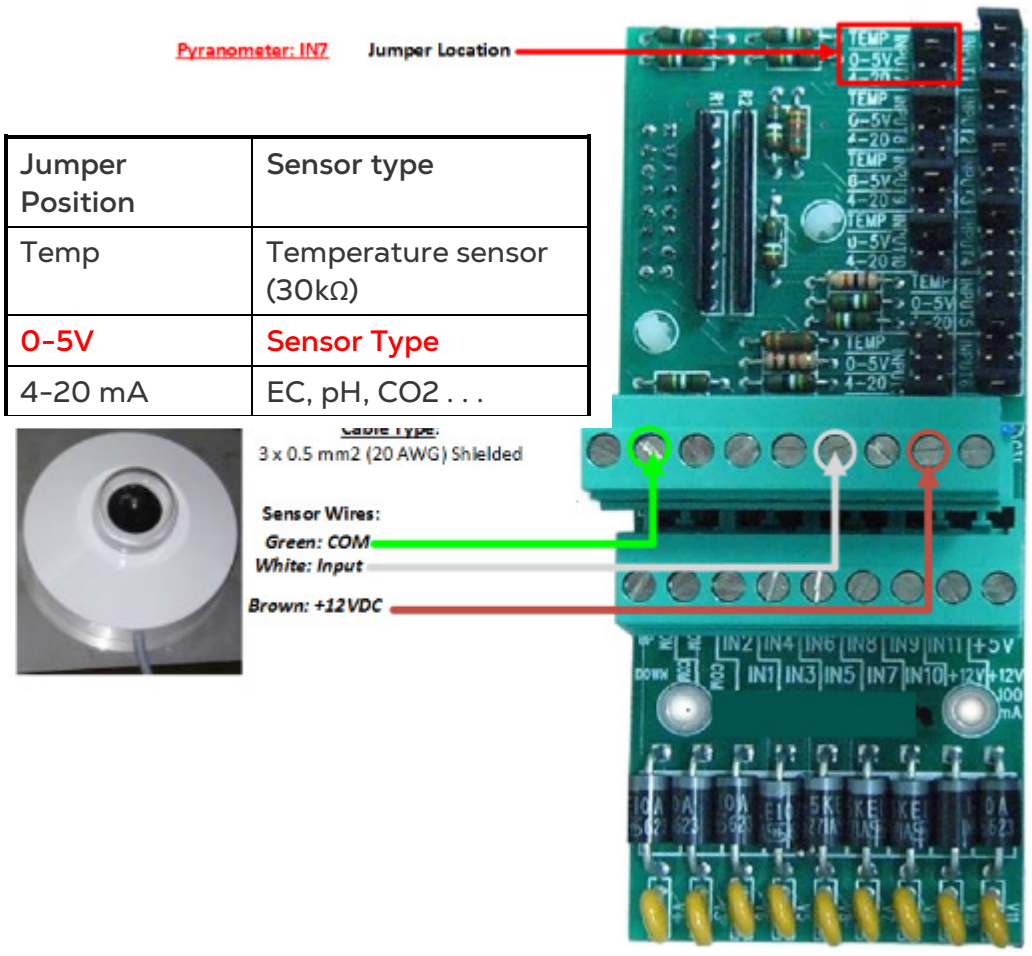

## 17.5 Radiation Sensor Definition

1. Main menu: Program, Manual, Alarm, History, Setup, Config, Installation. **SELECT** Installation.

2. INSTALLATION menu: 1. DEVICE LAYOUT, 2. DEVICE LIST, 3. DIGITAL INPUT 1, 4. DIGITAL INPUT 2, 5. ANALOG INPUT 1, 6. ANALOG INPUT 2, 7. HARDWARE CHECKLIST. **SELECT** ANALOG INPUT 1.

3. ANALOG INPUT No. 1 configuration: Channel Input Function No. Channel 7: EC Sensor, PH Sensor, Temp. Sensor, Humidity Sensor, Out Temp., Out Humidity, <None>, <None>, <None>, <None>, <None>, <None>. **SELECT** Radiation.

4. Confirmation screen: Channel 7-Radiation.

- Radiation Sensor Configuration – Munters
- Radiation Sensor Connection – Davis

### 17.5.1 RADIATION SENSOR CONFIGURATION – MUNTERS

1. Main menu: 1. Program, 2. Manual, 3. Alarm, 4. History, 5. Test, 6. Setup, 7. Config, 8. Install. **SELECT** Install.

2. CONFIGURATION menu: 1. VALUE CONFIGURATION, 2. VALUE FLOW RATE, 3. WATER METER, 4. DOSING CHANNEL CONFIGURATION, 5. DOSING CONFIGURATION, 6. EC PRE-CONTROL CONFIGURATION, 7. DRAINAGE CONFIGURATION, 8. SYSTEM PRESSURE CONFIGURATION, 9. RADIATION CONFIGURATION, 10. EC/PH CONFIGURATION. **SELECT** RADIATION CONFIGURATION.

3. RADIATION SENSOR CONFIGURATION: Radiation Sensor Type: NETAFIM. **SELECT** NETAFIM.

4. Confirmation screen: In order to use the radiation sensor, you must define a factor larger than zero! **SELECT**.

5. Confirmation screen: In order to use the radiation sensor, you must define a factor larger than zero! **SELECT**.

6. Main menu: 1. Program, 2. Manual, 3. Alarm, 4. History, 5. Test, 6. Setup, 7. Config, 8. Install. **SELECT** Setup.

7. SETUP menu: 1. TIME & DATE, 2. SYSTEM SETUP, 3. TEMPERATURE CALIBRATION, 4. HUMIDITY CALIBRATION, 5. EC/PH CALIBRATION, 6. PRESSURE CALIBRATION, 7. WEATHER STATION CALIBRATION, 8. SENSOR LOGGING, 9. WRITE TO DATA PLUG, 10. READ FROM DATA PLUG. **SELECT** WEATHER STATION CALIBRATION.

8. WEATHER STATION CALIBRATION: Value Factor table:  

Parameter	Value	Factor
Temperature	2.2	0.0
Humidity	100.0	0.0
Wind Direction	<NONE>	---
Radiation F.	<FAIL>	2.17
Rad. Offset	<FAIL>	0.00

**SELECT** Radiation F. (2.17).  
 Press (<-) Arrows to Increase/Decrease Enter Speeds Up Radiation Factor

9. WEATHER STATION CALIBRATION: Value Factor table:  

Parameter	Value	Factor
Temperature	2.2	0.0
Humidity	100.0	0.0
Wind Direction	<NONE>	---
Radiation F.	<FAIL>	2.17
Rad. Offset	<FAIL>	17.00

**SELECT** Rad. Offset (17.00).  
 Press (<-) Arrows to Increase/Decrease Enter Speeds Up Radiation Factor

10. Confirmation screen: Save Changes? **SELECT** YES.

11. Confirmation screen: Save Changes? **SELECT** YES.

**ATTENTION** Define Radiation Factor according to value on sensor millivolt/watt/m<sup>2</sup>. To Increase/Decrease faster, use arrows while holding down ENTER

**ATTENTION** Set Radiation Offset to ≥ 17.00 after sunset when there is no radiation

## 17.5.2 RADIATION SENSOR CONNECTION – DAVIS

Jumper Position	Sensor type
Temp	Temperature Sensor (30kΩ)
<b>0-5V</b>	<b>Radiation</b>
4-20 mA	EC, pH, CO2 ...

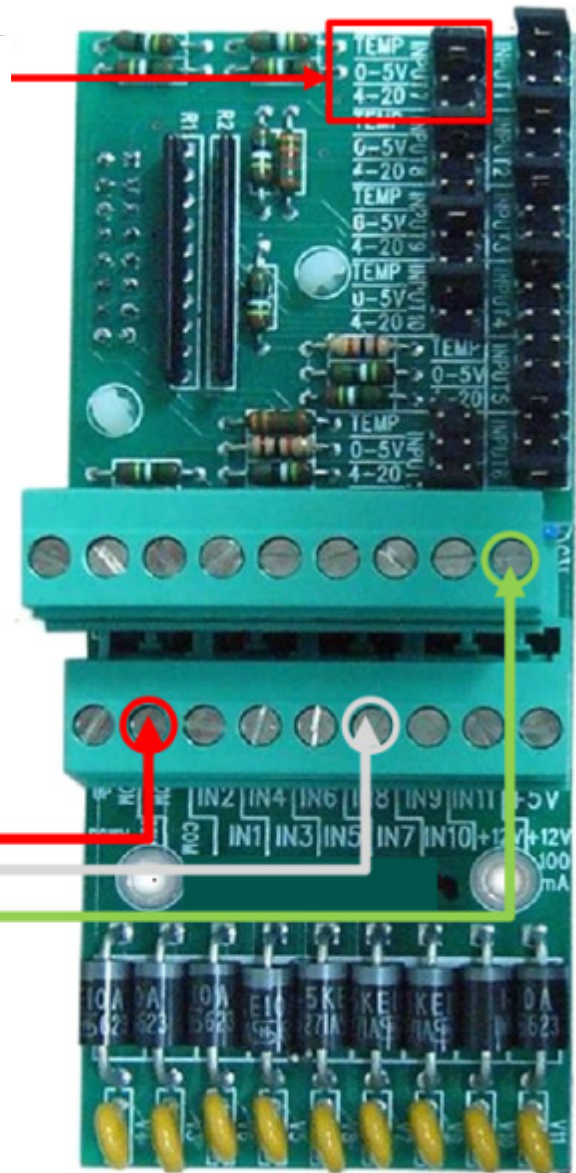

**Cable Type:**  
3 x 0.5 mm<sup>2</sup> (20 AWG) Shielded



**Sensor Wires:**

**Red: COM**  
**White: Input**  
**Green: +5V**

### 17.5.2.1 Radiation Sensor Definition

**1** Program Manual Alarm History  
SELECT Setup Config Installation

**2** INSTALLATION  
1. DEVICE LAYOUT  
2. DEVICE LIST  
3. DIGITAL INPUT 1  
4. DIGITAL INPUT 2  
5. ANALOG INPUT 1  
6. ANALOG INPUT 2  
7. HARDWARE CHECKLIST

**3** ANALOG INPUT No. 1  
Channel InPut Function No.  
1 EC Sensor  
2 PH Sensor  
3 Temp. Sensor  
4 Humidity Sensor  
5 Out Temp.  
6 Out Humidity  
7 <None>  
8 <None>  
9 <None>  
10 <None>  
11 <None>

**4** ANALOG INPUT No. 1  
Channel InPut Function No.  
1 EC Sensor  
2 PH Sensor  
3 Temp. Sensor  
4 Humidity Sensor  
5 Out Temp.  
6 Out Humidity  
7 Radiation  
8 <None>  
9 <None>  
10 <None>  
11 <None>

Channel 7-Radiation



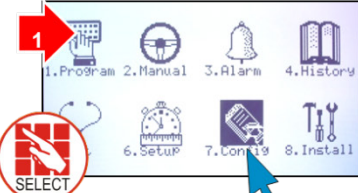

## 17.5.2.2 Radiation Sensor Configuration - Option B- Davis

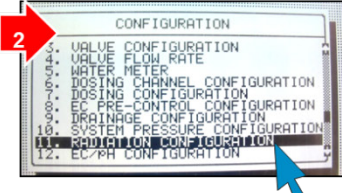
**1** 

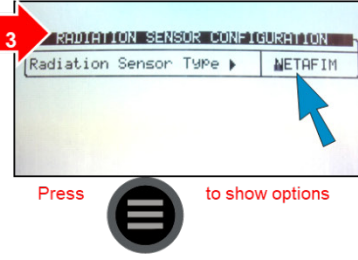
**2** 

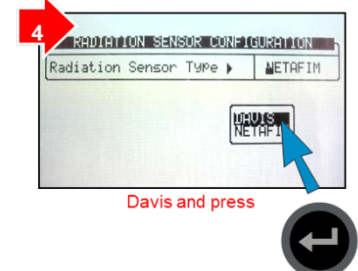
**3** 

**4** 

**5** 

**6** 

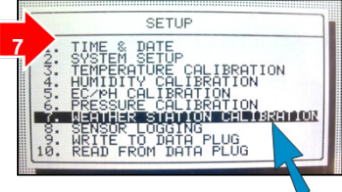
**7** 

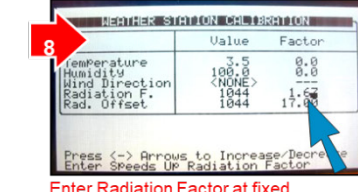
**8** 

	Value	Factor
Temperature	7.5	0.0
Humidity	100.0	0.0
Wind Direction	<NONE>	---
Radiation F.	1.67	---
Rad. Offset	1044	17.00

**9** 

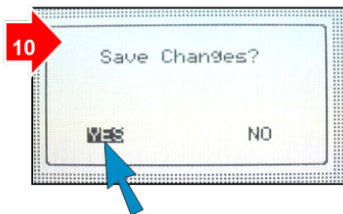
**10** 

## 17.6 Pressure Transducer Connection

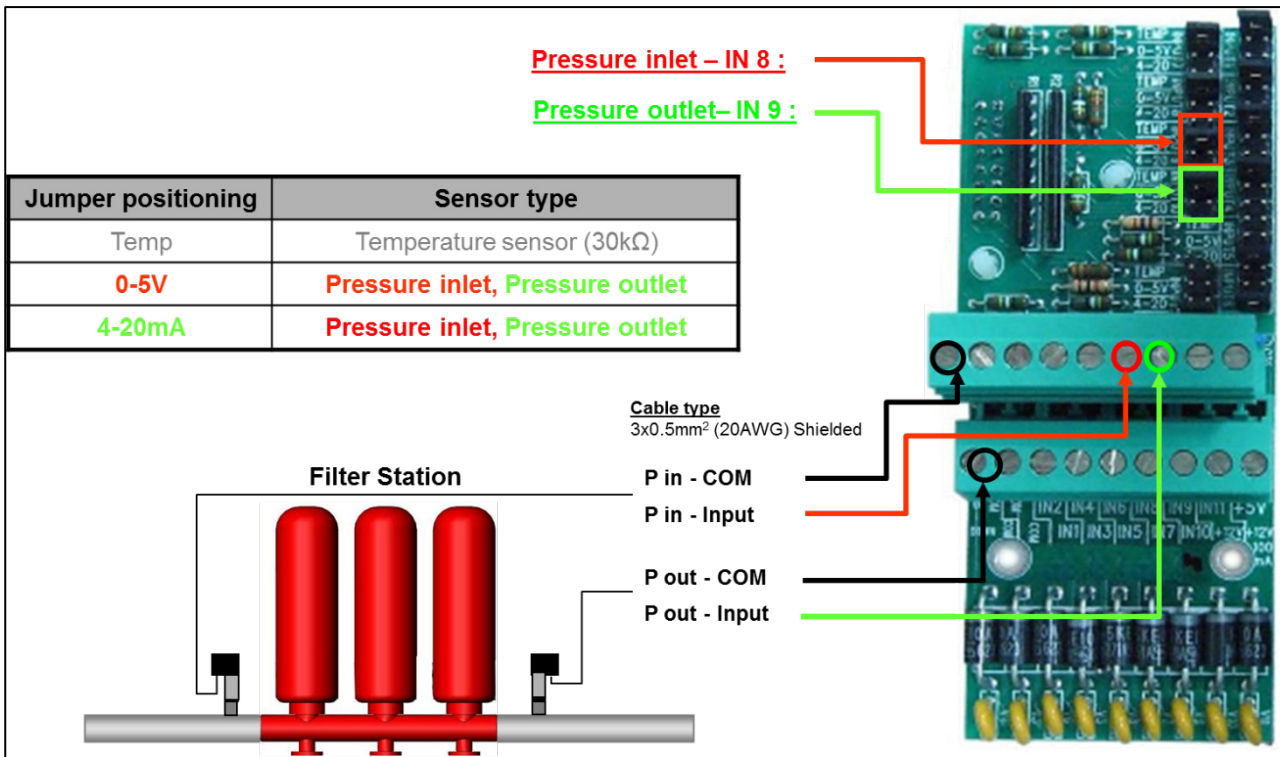

### 17.6.1 ANALOG PRESSURE SENSOR DEFINITION

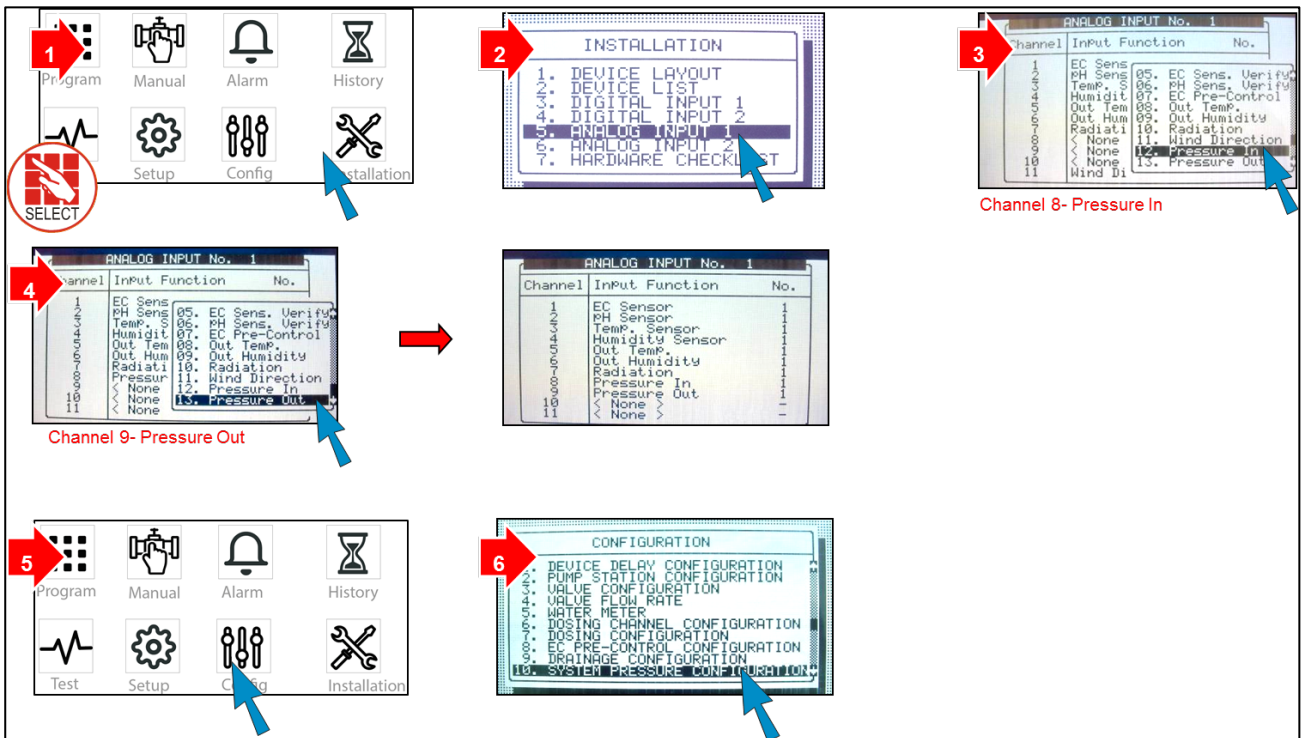

**Highly recommended!**

**ATTENTION**

**8**

**9**

**ATTENTION**

Define units 0-5V or 4-20 mA according to sensor range (ex: 0-10 bar)

**10**

**11**

**12**

**13**

**CHECK**

Pressure value matches value on pressure gauge of main line

## 17.7 Wind Direction Connection

Jumper positioning	Sensor type
Temp	Temperature sensor (30KΩ)
0-5V	Humidity, Radiation, Pressure

Jumper location  
Wind d: IN11

**Cable type:**  
4.0 x 5 mm<sup>2</sup> (20 AWG)

To digital input card



**Sensors**

**Black: DI**

**Red: COM**

**Green: Input**

**Yellow: +5V**

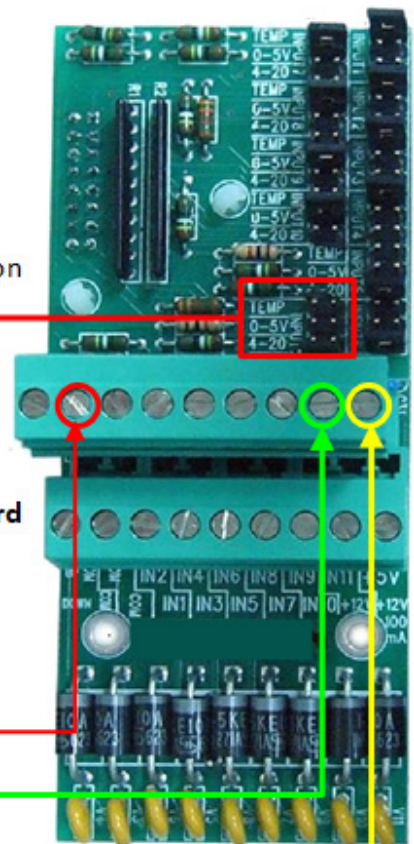

- Wind Direction Sensor Definition

- Wind Speed Digital Input Definition

### 17.7.1 WIND DIRECTION SENSOR DEFINITION

**1** Program Manual Alarm History  
Test Setup Config Installation  
**SELECT**

**2** INSTALLATION  
1. DEVICE LAYOUT  
2. DEVICE LIST  
3. DIGITAL INPUT 1  
4. DIGITAL INPUT 2  
5. ANALOG INPUT 1  
6. ANALOG INPUT 2  
7. HARDWARE CHECKLIST

**3** ANALOG INPUT No. 1  
Channel Input Function No.  
1 EC Sens 04. PH Sensor  
2 PH Sens 05. PH Sensor, Verify  
3 Temp. 06. PH Sens. Verify  
4 Humidit 06. PH Sens. Verify  
5 Out Temp 07. EC Pre-control  
6 Out Hum 08. Out Temp  
7 EC Pre- 09. Out Humidity  
8 Pressure 10. Radiation  
9 < None > 11. Wind direction  
10 < None > 12. Pressure In  
11 < None >

Wind direction in channel 11

**4** Program Manual Alarm History  
Test Setup Config Installation

**5** SETUP  
1. TIME & DATE  
2. SYSTEM SETUP  
3. TEMPERATURE CALIBRATION  
4. HUMIDITY CALIBRATION  
5. EC/PH CALIBRATION  
6. PRESSURE CALIBRATION  
7. ANALOG INPUT CALIBRATION  
8. SENSOR LOGGING  
9. WRITE TO DATA PLUG  
10. READ FROM DATA PLUG

**6** ANALOG INPUT CALIBRATION  
Value Factor  
Temperature 3.4 -0.1  
Humidity 100.0 0.0  
Wind direction 1110 1  
Radiation F. 1051 10.24  
Rad. Offset 1051 10.24  
Press (<-) Arrows to Increase/Decrease  
Enter Speeds Up Radiation Factor

Wind direction using a compass

ANALOG INPUT CALIBRATION  
Value Factor  
Temperature 3.4 -0.1  
Humidity 100.0 0.0  
Wind direction 1110 1  
Radiation F. 1110 10.24  
Rad. Offset 1110 10.24  
Press (<-) Arrows to Increase/Decrease  
Enter Speeds Up Radiation Factor

Enter value in the controller

### 17.7.2 WIND SPEED DIGITAL INPUT DEFINITION

**1** Program Manual Alarm History  
Test Setup Config Installation  
**SELECT**

**2** INSTALLATION  
1. DEVICE LAYOUT  
2. DEVICE LIST  
3. DIGITAL INPUT 1  
4. DIGITAL INPUT 2  
5. ANALOG INPUT 1  
6. ANALOG INPUT 2  
7. HARDWARE CHECKLIST

**3** DIGITAL INPUT  
In Input Function  
LOCAL 1 48. Dry Contact 15  
LOCAL 2 49. Dry Contact 16  
LOCAL 3 50. Fresh Tank Empty  
LOCAL 4 51. Drain Tank Empty  
LOCAL 5 52. Wind Speed  
LOCAL 6 53. Rain Collector  
LOCAL 7 54. Reset Alarm  
LOCAL 8 55. External Alarm  
LOCAL 9 56. External Alarm  
LOCAL 10 57. External Alarm 3

DIGITAL INPUT  
In Input Function  
LOCAL 1 Water Meter 1  
LOCAL 2 Pos. Bst Protection  
LOCAL 3 Delta Pressure  
LOCAL 4 Wind Speed  
LOCAL 5 < None >  
LOCAL 6 < None >  
LOCAL 7 < None >  
LOCAL 8 < None >  
LOCAL 9 < None >  
LOCAL 10 < None >

## 17.8 Sensor and Cable Specifications

Sensor Type	Measured Values	Accuracy	Input Range	Maximum Cable Length	Cable Type
Temperature - RTS-s	-20° to 50° C/ -4° to 122°F	0.3°C/0.54°F	30 kOhm	500 meter (1640 feet)	2x0.5 mm <sup>2</sup> (20 AWG)
EC	0 to 10 mS (old transmitters used 20 mS)	0.05 to 0.1 mS	4 – 20 mA	---	3x0.5 mm <sup>2</sup> (20 AWG) Shielded
pH	0 - 14	0.1	4 – 20 mA	---	
RH – RHS-10	0 – 100%	±2% (10%- 90% RH), ±3.5% (90%- 100% RH)	0 – 3 VDC	300 meter (985 feet)	3x0.5 mm <sup>2</sup> (20 AWG)
Solar Radiation- Davis	300-1100 nanometer (Up to 1500W/m <sup>2</sup> )	±5%	0 – 3 VDC	100 meter (330 feet)	3x0.5 mm <sup>2</sup> (20 AWG) Shielded
Pyranometer- Munters	300-2800 nanometer (Up to 1500 W/m <sup>2</sup> )	±5%	0 – 5 VDC	---	
Wind Direction	0 - 360°	±7%	0 – 20 kOhm	100 meter (330 feet)	4x0.5 mm <sup>2</sup> (20 AWG)
Wind Speed	4-280 km/hr (2-175 mph)	±5%	Pulse output (Wind Cups & Magnetic Switch)		
Pressure	Up to 10bar (145 PSI)	Check data sheet of the sensor used	0 – 5 VDC	Check data sheet of the sensor used	3x0.5mm <sup>2</sup> (20 AWG) Shielded
Rain Collector	Rain amount (mm or inch) Collection area: 200 cm <sup>2</sup> (31 inch <sup>2</sup> ) Resolution: 0.254mm (0.01")	±2%, Rainfall count between 0.2-50 mm/hr (0.01 - 2"/hr) ±3%, Rainfall count between 50- 150 mm/hr (2-4"/hr)	Dry contact (tipping bucket)	100 meter (330 feet)	---

Sensor Type	Measured Values	Accuracy	Input Range	Maximum Cable Length	Cable Type
Rain Detector	Rain, No Rain	0.2mm/hr	Dry contact/ 0-5 VDC		

# 18 Appendix E- Technical Specifications

- Technical Specifications
- Controller Components

## 18.1 Technical Specifications

Housing	Plastic housing with a screw on lid	IP 65
	Dimensions (L x W x H)	30 x 40 x 18 cm (11.81 x 15.75 x 7.08 inches)
	Weight	6.0 kg / 13.2 lbs.
Ambient Conditions	Operating temperature range	0 to +50 Celsius (14 to 122 Fahrenheit)
	Storage temperature range	-10 to +70 Celsius (14 to 158 Fahrenheit)
Approvals	The 115/230VAC has Safety CE approval	EN61010-1
	EMC approvals CE and FCC	EN55011 Group1 Class A EN61000-3-3; EN61000-6-2; CISPR 11 GROUP 1 CLASS A FCC Part 15 Subpart B

## 18.2 Controller Components

- Keyboard & Display, page 178
- CPU, page 178
- Power Supply, page 178
- Digital Input, page 181
- Analog Input, page 181

### 18.2.1 KEYBOARD & DISPLAY

- Graphical LCD Display
- Back light
- 5.5"
  
- Tactile feel Keyboard

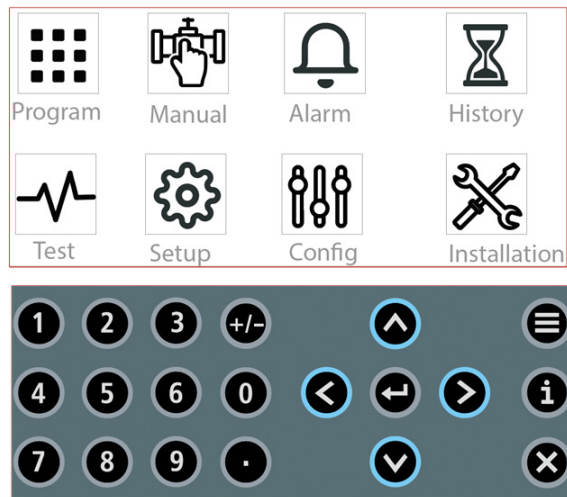

### 18.2.2 CPU

- 32bit CPU
- 8Mb Flash memory
- Settings backup & software upgrade through SD memory card

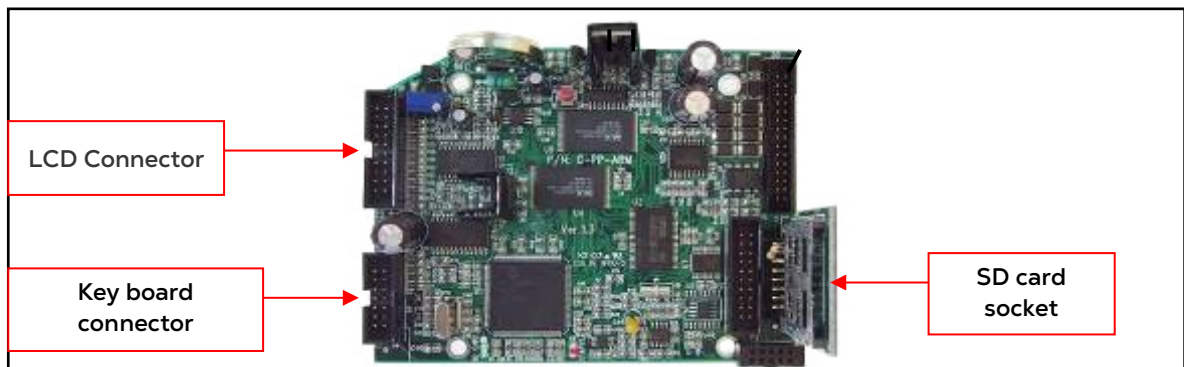

### 18.2.3 POWER SUPPLY



- AC Power Supply
  - 230/115 VAC (±10%)
- Protection
  - Thermal fuse



- Current detector: short circuit detection
- Power Consumption
  - Whole system Display ON with all relays turned Off – 450 mA.
  - Whole system Display OFF with all relays turned Off – 370 mA.
  - Each relay turned ON – adds 50 mA.
  - Each Relay/IO card added/removed – adds/removes 10 mA.

Table 2: Electrical Specifications

Specifications				
Main voltage	Main frequency	Max voltage	Min voltage	Main fuse
Single phase 230 VAC, 0.5 Amp	50/60 H	250 VAC	200 VAC	0.5 Amp
Single phase 110 VAC, 0.5 Amp	50/60 H	130 VAC	90 VAC	0.5 Amp

**CAUTION** GreenField units support 115 VAC, 230 VAC, or both. Each unit has a silver label stating the unit's voltage. Verify that the power supply matches the unit's requirements.

### 18.2.3.1 Power Supply Circuit Drawing

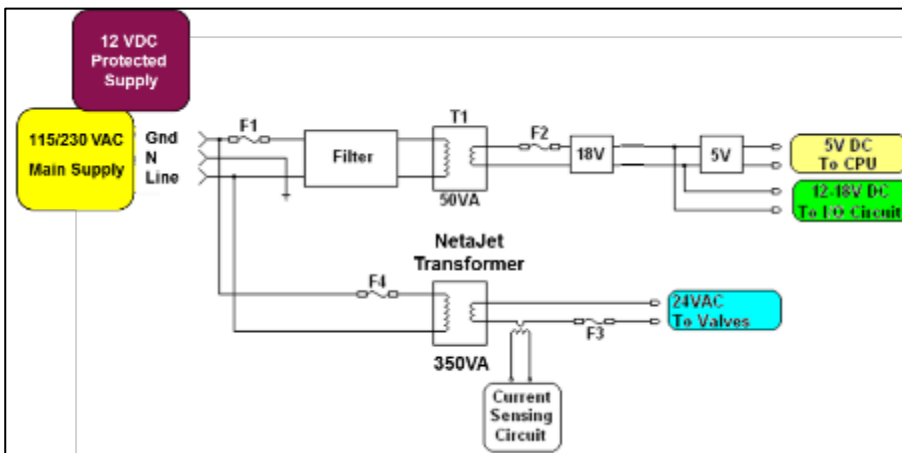

### 18.2.3.2 Power Supply Fuse Protection

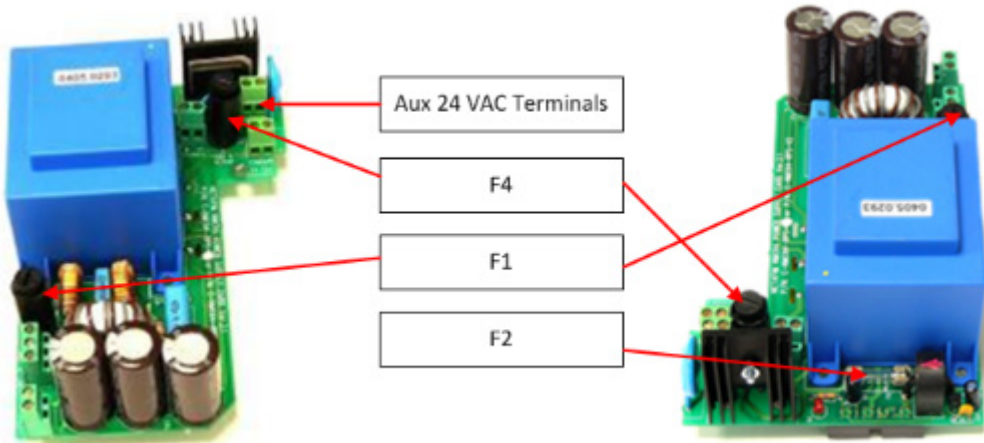

Location	Designation	Type	Style	Rating	Reaction Time	Dimensions
GREENFIELD Power Supply, Main Transformer T1	F1	Tubular Glass	M205	1.0 Amp	Slow Blow (T)	20mm x 5mm
GREENFIELD Power Supply, CPU & I/O Circuit	F2	Tubular Glass	M205	4.0 Amp	Slow Blow (T)	20mm x 5mm
GREENFIELD Power Supply, 24VAC Output Circuit*	F3	Thermal		9.0 Amp	Thermal	
GREENFIELD Power Supply, Output Fertigation Trans.	F4	Tubular Glass	M205	1.25 Amp	Slow Blow (T)	20mm x 5mm

\* Back side of power supply card

### 18.2.3.3 Output

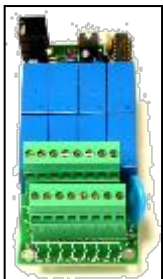

- 24 VAC / output card
- 8 x D.O. AC Relay
- Output rating = 5 Amps
- Single output changing rate = 0.4 Sec

#### SingleNet License Key



- Communication protocol with SingleNet interface

## 18.2.4 DIGITAL INPUT



- 8 x D.I. Inputs
- Dry contact input (5V/2mAmp)
- Maximum pulse rate 50pulse/sec (<50 Hz)

## 18.2.5 ANALOG INPUT



- Inputs 1 – 10: Temperature (NTC 30K $\Omega$ ), 0-5VDC (Radiation, Relative Humidity, Pressure...), 4-20mA (EC, pH, Pressure...)
- Input 11: Wind direction (Potentiometer), Temperature (NTC 30K $\Omega$ ), 0-5VDC (Radiation, Relative Humidity, Pressure...), 4-20mA (EC, pH, Pressure...)

### Common Analog Sensor Specifications

Sensor	Measured Values	Input Range
Temperature – RTS-s	-20°C to 50°C/ -4°F to 122°F	30kOhm
EC	0 to 10mS (old transmitters used 20 mS)	4 – 20mA
pH	0 - 14	4 – 20mA
RH – RHS-10	0 – 100%	0 – 3 VDC
WD - Davis	0 - 360°	0 – 20kOhm
Pressure	Up to 10bar (145 PSI)	0 – 5 VDC
Radiation	0 – 1800 w/m <sup>2</sup>	0 – 5 VDC

## 18.2.6 ANALOG OUTPUT



- Four outputs
- 4 – 20 mA output
- 24 VAC power supply

# 19 Appendix F - Main Menu Tree

Program	Manual	Alarm	History	Test	Setup	Configuration	Installation
Irrigation	Irrigation Pause	Alarm Reset	Irrigation Log	Relays	Time & Date	Device Delay Configuration	Device layout
Water Run Time	Start/Stop Program	History	Rad. Sum & Drain Log	Digital Input	System Setup	Pump Station Configuration	Device List
Dosing	Start/Stop Valve	Alarm Definition	Uncompleted Irrigation	Analog Input	Temp Calibration	Valve Configuration	Digital Input
External Condition	Filter Flushing	Alarm Setting	Uncompleted Programs	Temperature	Humidity Calibration	Valve Flow Configuration	Analog Input 1
Agitator		EC/pH Alarm Setting	Daily Irrigation	Humidity	EC/pH Calibration	Water Meter	Analog Input 2
Selector		EC/pH Alarm Setting	Irrigation Accumulation	Hardware Checklist	Pressure Calibration	Dosing Channel Configuration	Hardware Checklist
Filter Flushing		SMS Subscription	Water & Auxiliary Meter Accumulation		Weather Station Calibration	Dosing Configuration	
Cooling			Accumulation Reset		Sensor Calibration	EC Pre-Control Configuration	
Misting			Filters		Write to Data Plug	Drainage Configuration	
Water Heating			Cooling		Read from Calibration	System Pressure Configuration	
						Radiation Configuration	
						Pressure Sensor Range Definition	
						Cooling Configuration	
						Misting Configuration	

# 20Warranty

## Warranty and technical assistance

Munters products are designed and built to provide reliable and satisfactory performance but cannot be guaranteed free of faults; although they are reliable products they can develop unforeseeable defects and the user must take this into account and arrange adequate emergency or alarm systems if failure to operate could cause damage to the articles for which the Munters plant was required: if this is not done, the user is fully responsible for the damage which they could suffer.

Munters extends this limited warranty to the first purchaser and guarantees its products to be free from defects originating in manufacture or materials for one year from the date of delivery, provided that suitable transport, storage, installation and maintenance terms are complied with. The warranty does not apply if the products have been repaired without express authorisation from Munters, or repaired in such a way that, in Munters' judgement, their performance and reliability have been impaired, or incorrectly installed, or subjected to improper use. The user accepts total responsibility for incorrect use of the products.

The warranty on products from outside suppliers fitted to GreenField, (for example antennas, power supplies, cables, etc.) is limited to the conditions stated by the supplier: all claims must be made in writing within eight days of the discovery of the defect and within 12 months of the delivery of the defective product. Munters has thirty days from the date of receipt in which to take action, and has the right to examine the product at the customer's premises or at its own plant (carriage cost to be borne by the customer).

Munters at its sole discretion has the option of replacing or repairing, free of charge, products which it considers defective, and will arrange for their despatch back to the customer carriage paid. In the case of faulty parts of small commercial value which are widely available (such as bolts, etc.) for urgent despatch, where the cost of carriage would exceed the value of the parts, Munters may authorise the customer exclusively to purchase the replacement parts locally; Munters will reimburse the value of the product at its cost price.

Munters will not be liable for costs incurred in demounting the defective part, or the time required to travel to site and the associated travel costs. No agent, employee or dealer is authorised to give any further guarantees or to accept any other liability on Munters' behalf in connection with other Munters products, except in writing with the signature of one of the Company's Managers.

**WARNING:** In the interests of improving the quality of its products and services, Munters reserves the right at any time and without prior notice to alter the specifications in this manual.

The liability of the manufacturer Munters ceases in the event of:

- dismantling the safety devices;
- use of unauthorised materials;
- inadequate maintenance;
- use of non-original spare parts and accessories.

Barring specific contractual terms, the following are directly at the user's expense:

- preparing installation sites;
- providing an electricity supply (including the protective equipotential bonding (PE) conductor, in accordance with CEI EN 60204-1, paragraph 8.2), for correctly connecting the equipment to the mains electricity supply;
- providing ancillary services appropriate to the requirements of the plant on the basis of the information supplied with regard to installation;
- tools and consumables required for fitting and installation;
- lubricants necessary for commissioning and maintenance.

It is mandatory to purchase and use only original spare parts or those recommended by the manufacturer.

Dismantling and assembly must be performed by qualified technicians and according to the manufacturer's instructions.

The use of non-original spare parts or incorrect assembly exonerates the manufacturer from all liability.

Requests for technical assistance and spare parts can be made directly to the nearest [Munters office](#).

