

Installation Manual

Green DC



Green DC

Climate Controller

Ag/MIS/UmEN-2730-05/19 Rev 1.1
P/N: 116817



Green DC

Installation Manual

Rev 1.1, 05/2024

This manual for use and maintenance is an integral part of the apparatus together with the attached technical documentation.

This document is destined for the user of the apparatus: it may not be reproduced in whole or in part, committed to computer memory as a file or delivered to third parties without the prior authorization of the assembler of the system.

Munters reserves the right to effect modifications to the apparatus in accordance with technical and legal developments.

Index

<i>chapter</i>		<i>page</i>
1	INTRODUCTION	9
	1.1 Disclaimer.....	9
	1.2 Introduction	9
	1.3 Notes	9
2	GENERAL INSTRUCTIONS.....	10
3	BASIC REQUIREMENTS FOR ON-SITE PREPARATION.....	11
	3.1 General Dimensions	11
	3.2 Solar Panel and Controller Installation	12
4	POWER SUPPLY WIRING	13
	4.1 Main Battery Wiring	13
	4.2 Solar Panel Wiring.....	15
	4.3 Cold Start.....	15
	4.4 Set Language, Time and Date.....	16
5	ELECTRICAL INSTALLATION.....	17
	5.1 Input/Output Layout.....	17
	5.2 Modular I/O Bus	18
	5.3 Controller Hardware Verification	18
	5.4 Solenoid Installation	19
	5.5 Output Terminal.....	20
	5.5.1 12V DC Latch Connection	20
	5.5.2 12V DC Latch Hydraulic Connection.....	20
	5.6 Input Terminals.....	21
	5.7 Digital Input Connections	22
	5.8 Analog Input Connections	22
	5.8.1 Analog Input Dip Switch Selections	23
	5.9 PC and Inter-Controller Communication	24
6	CONTROLLER SET-UP	25
	6.1 Hardware Checklist	25
	6.2 Output Definition	25
	6.3 Digital Input Definition.....	26
	6.4 Analog Input Definition.....	27
7	CONTROLLER TEST PROCEDURE.....	28
	7.1 Test Relays	28

7.2	Digital Input Test.....	29
7.3	Analog Input Test.....	29
7.4	Power & Communication Test	30
8	SYSTEM CONFIGURATION PROCEDURE	31
8.1	Device Delay Configuration	31
8.2	Pump Station Configuration.....	32
8.3	Valve Configuration	32
8.4	Valve Flow Rate	32
8.5	Water Meter	33
8.6	Dosing Channel Configuration.....	33
8.7	Dosing Configuration	33
8.8	EC/pH Sensor Range.....	34
8.9	History Resolution	34
8.10	System Nutrigation™	35
	8.10.1 Simulation.....	36
	8.10.2 Water Run Time.....	36
	8.10.3 Start/Stop Valve.....	37
8.11	Data Plug	37
9	PROGRAM.....	38
9.1	Irrigation.....	38
	9.1.1 Setting irrigation that is longer than 24H.....	42
9.2	Water Run Time.....	42
9.3	Dosing	43
	9.3.1 Dosing Program	43
9.4	EXT. Condition	45
9.5	Agitator	46
9.6	Selector	46
9.7	Filter Flushing.....	47
9.8	Cooling.....	47
9.9	Misting.....	50
9.10	Water Heating	51
10	MANUAL OPERATION	52
10.1	Irrigation Pause.....	52
10.2	Start/Stop Program	53
10.3	Start/Stop Valve.....	53
10.4	Filter Flushing.....	54
11	ALARM	55
11.1	Alarm Reset	55
11.2	History.....	56
11.3	Alarm Definition	56

11.4	Alarm Setting.....	58
11.5	EC/pH Alarm Definition.....	59
11.6	EC/pH Alarm Setting.....	59
11.7	Radio SYS. Alarm Definition.....	60
11.8	Radio Sys. Alarm View.....	60
11.9	SMS Subscription.....	61
12	HISTORY.....	62
12.1	Irrigation Log.....	63
12.2	RAD. / VPD Sum & Drain Log.....	63
12.3	Uncompleted Irrigation.....	64
12.4	Uncompleted Programs.....	65
12.5	Daily Irrigation.....	65
12.6	Irrigation Accumulation.....	66
12.7	AUX Meter Accumulation.....	66
12.8	Accumulation Reset.....	67
12.9	Filters.....	67
12.10	Cooling.....	68
12.11	Sensors Log.....	68
12.12	Event Log.....	69
12.13	System Log.....	69
13	TEST.....	70
13.1	Relays.....	70
13.2	Digital Input.....	71
13.3	Analog Input.....	72
13.4	Temperature.....	73
13.5	Humidity.....	73
13.6	Hardware Check List.....	73
14	SETUP.....	75
14.1	Time & Date.....	76
14.2	System Setup.....	77
14.3	Temperature Calibration.....	80
14.4	Humidity Calibration.....	80
14.5	EC/pH Calibration.....	80
14.5.1	Calibration of the EC/pH Monitor Transmitter.....	80
14.5.1.1	EC Calibration.....	80
14.5.1.2	pH Calibration.....	82
14.5.2	EC/pH Transmitter Monitor & Green Field ECO Correlation.....	83
14.6	Pressure Calibration.....	84
14.7	Weather Station Calibration.....	84
14.8	Sensors Logging.....	85

14.9	Write to Data Plug.....	85
14.10	Read from Data Plug.....	85
14.11	Edit SMS Phonebook.....	86
14.12	SMS Setup.....	86
14.13	SMS Personal Message.....	86
15	CONFIGURATION	87
15.1	Device Delay Configuration.....	88
15.2	Pump Station Configuration.....	90
15.3	Valve Configuration.....	91
15.4	Valve Flow Rate.....	92
15.5	Water Meter.....	92
15.6	Dosing Channel Configuration.....	94
15.7	Dosing Configuration.....	95
15.8	EC Pre-Control Configuration.....	96
15.9	Drainage Configuration.....	97
15.10	System Pressure Configuration.....	97
15.11	EC/pH Range Definition.....	98
15.12	Pressure Sensor Range Definition.....	98
15.13	Cooling Configuration.....	99
15.14	Misting Configuration.....	99
16	INSTALLATION	100
16.1	Device Layout.....	100
16.2	Device List.....	102
16.3	Digital Input.....	102
16.4	Analog Input 1-2.....	103
16.5	Hardware Checklist.....	103
17	CONTROLLER ADVANCED SETTINGS	104
17.1	Pump Station Configuration.....	104
17.2	Multiple Water Meters.....	105
17.2.1	Option A: Standard Use/Measurement.....	105
17.2.2	Option B: Multiple Water Sources.....	105
17.3	Drain Meter Measurement.....	106
17.3.1	Option A: Total Measurement.....	106
17.3.2	Option B: Sample Measurement.....	106
17.4	Drainage Timing.....	106
17.4.1	Drainage Timing Option A.....	107
17.4.2	Drainage Timing Option B.....	107
17.5	Drain Log.....	108
17.6	Various Dosing Channel Configurations.....	108
17.6.1	Method 1.....	108

17.6.2	Method 2	108
17.6.3	Method 3	109
17.7	Dosing Configuration	109
17.7.1	EC/pH Control.....	109
17.7.2	EC/pH Control- Alarm Setting	110
17.8	Dual EC/pH Sensors.....	110
17.9	Advanced System Setup.....	111
17.10	Hot Keys And Status Screens	112
17.11	Operation Mode.....	112
18	APPENDIX A: PARTS LIST	115
19	APPENDIX B: TROUBLESHOOTING	116
19.1	Power Failure	116
19.2	"No Flow" Alarm	117
19.3	"Sensor Fail" Alarm	117
19.4	Display Backlight Failure	118
20	APPENDIX C: REPLACEMENTS AND ADDITIONAL INSTALLATIONS	119
20.1	Install 8 Latch Output Card	119
20.2	Remove a Card.....	120
20.3	LCD & Keyboard Replacement	120
21	APPENDIX D: SENSOR INSTALLATION AND DEFINITION	121
21.1	EC: pH Sensor Connection	121
21.2	Outside Temp/Hum Sensor Connection.....	122
21.3	Sensor Definition	122
21.4	Pyranometer Connection	123
21.5	Radiation Sensor Definition	123
21.6	Radiation Sensor Configuration	124
21.7	Pressure Transducer Connection	125
21.8	Analog Pressure Sensor Definition	125
21.9	Sensor and Cable Specifications	126
22	APPENDIX E: TECHNICAL SPECIFICATIONS	128
22.1	Technical Specifications	128
22.2	Controller Components	128
22.2.1	Keyboard & Display	129
22.2.2	CPU	129
22.2.3	Power Supply	129
22.3	Power Supply Fuse Protection	130
22.4	Outputs	131
22.4.1	12V DC Latch Output Card	131
22.4.2	Digital & Analog Input Card	131
22.5	Common Analog Sensor Specifications.....	132

1 Introduction

1.1 Disclaimer

Munters reserves the right to make alterations to specifications, quantities, dimensions etc. for production or other reasons, subsequent to publication. The information contained herein has been prepared by qualified experts within Munters. While we believe the information is accurate and complete, we make no warranty or representation for any particular purposes. The information is offered in good faith and with the understanding that any use of the units or accessories in breach of the directions and warnings in this document is at the sole discretion and risk of the user.

1.2 Introduction

Congratulations on your excellent choice of purchasing an Green DC!

In order to realize the full benefit from this product it is important that it is installed, commissioned and operated correctly. Before installation or using the controller, this manual should be studied carefully. It is also recommended that it is kept safely for future reference. The manual is intended as a reference for installation, commissioning and day-to-day operation of the Munters Controllers.

1.3 Notes

Date of release: June 2020

Munters cannot guarantee to inform users about the changes or to distribute new manuals to them.

All rights reserved. No part of this manual may be reproduced in any manner whatsoever without the expressed written permission of Munters. The contents of this manual are subject to change without notice.

2 General Instructions

- Installation should be performed by authorized technicians only.
- Verify that field components are working properly.
- All safety regulations are to be applied.
- Do not apply force or pressure on components during the installation procedure.
- Refer to your supervisor if problems occur during installation procedure.

3 Basic Requirements for On-Site Preparation

- Verify Main Battery 12VDC and solar panel.
- Environment temperature between (-10°C)-(+60°C).
- Verify protection from damaging climate conditions.

- General Dimensions
- Solar Panel and Controller Installation

3.1 General Dimensions

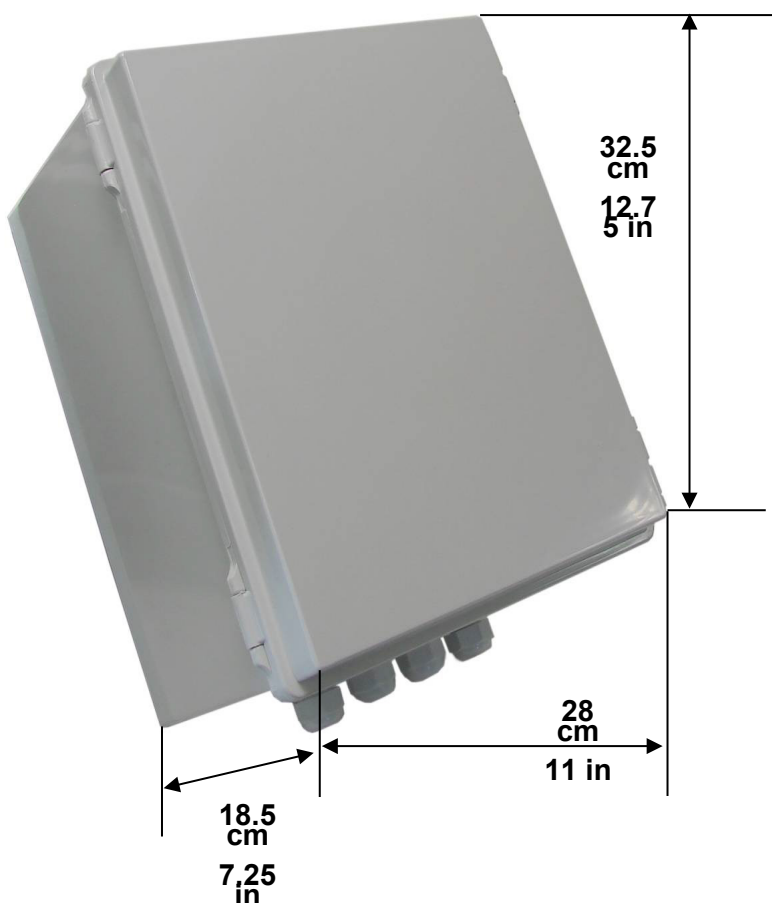

3.2 Solar Panel and Controller Installation

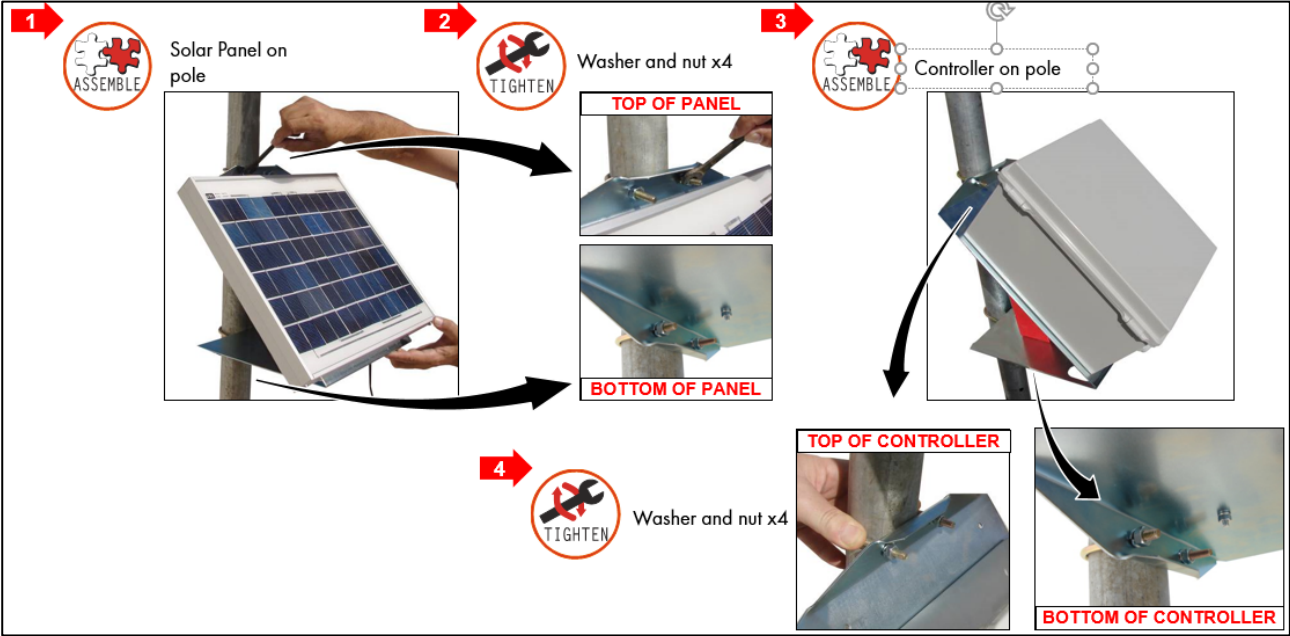

4 Power Supply Wiring

- Main Battery Wiring
- Solar Panel Wiring
- Cold Start
- Set Language, Time and Date

4.1 Main Battery Wiring

WARNING! Shock Hazard! Only a qualified electrician may install this product.

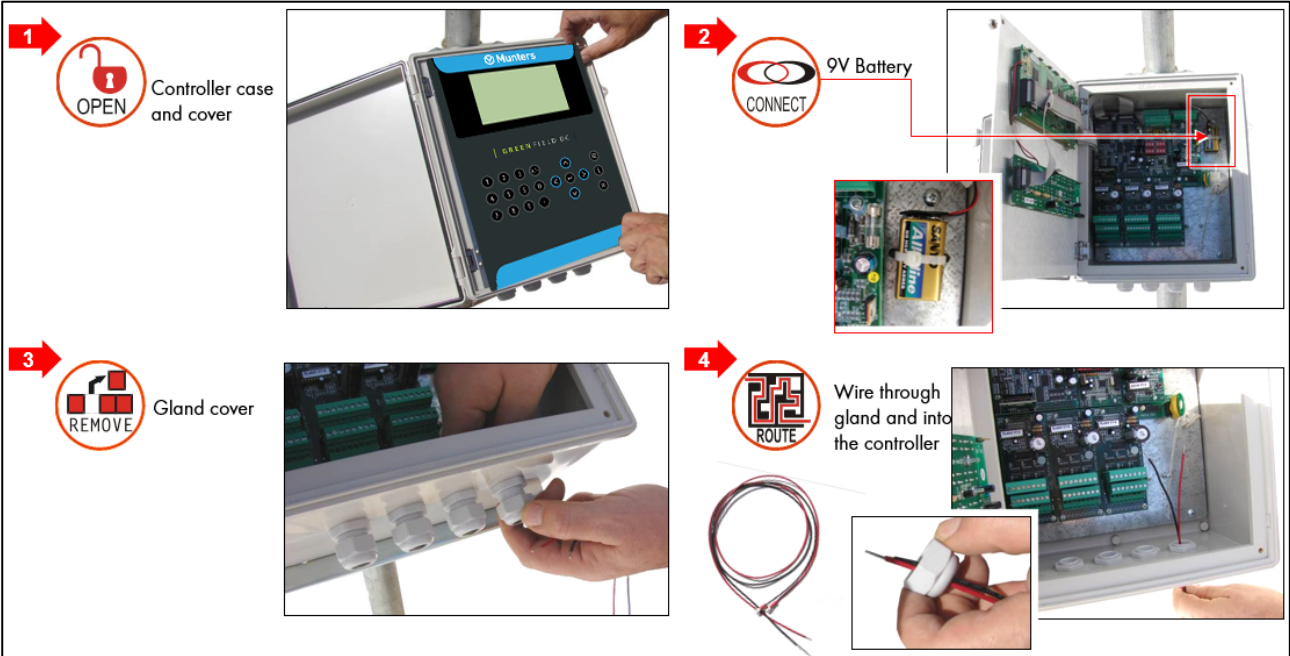

5

LOOSEN Terminal screw

INSERT Wires as shown

TIGHTEN Terminal screw

ATTENTION Battery switch is in OFF position!

6

ROUTE Wires

CONNECT Wires to 12VDC battery

NOTE: Recommended battery is 17Ah or more.

NOTE The Green Field DC unit is supplied with a 12V, 17 Ah battery. If you replace the battery with one which is less than 9 Ah, remove the jumper from Position J1. See the graphic below.

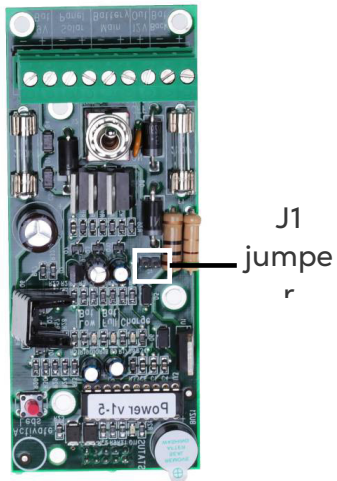

4.2 Solar Panel Wiring

1 Solar Power Cable

2 Cable into Controller through gland

3 Sleeves to expose wires

4 Terminal screw
 Wires as shown
 Terminal screw

9V Battery
 Solar Panel
 Main Battery

4.3 Cold Start

NOTE In order to perform a cold start or firmware upgrade, the controller must be in the "Technician" mode, refer to Operation Mode, page 112.

1 Battery Switch

2 Delete

COLD START?
 YES NO

In case cold start was not done on time:
2 Brown button

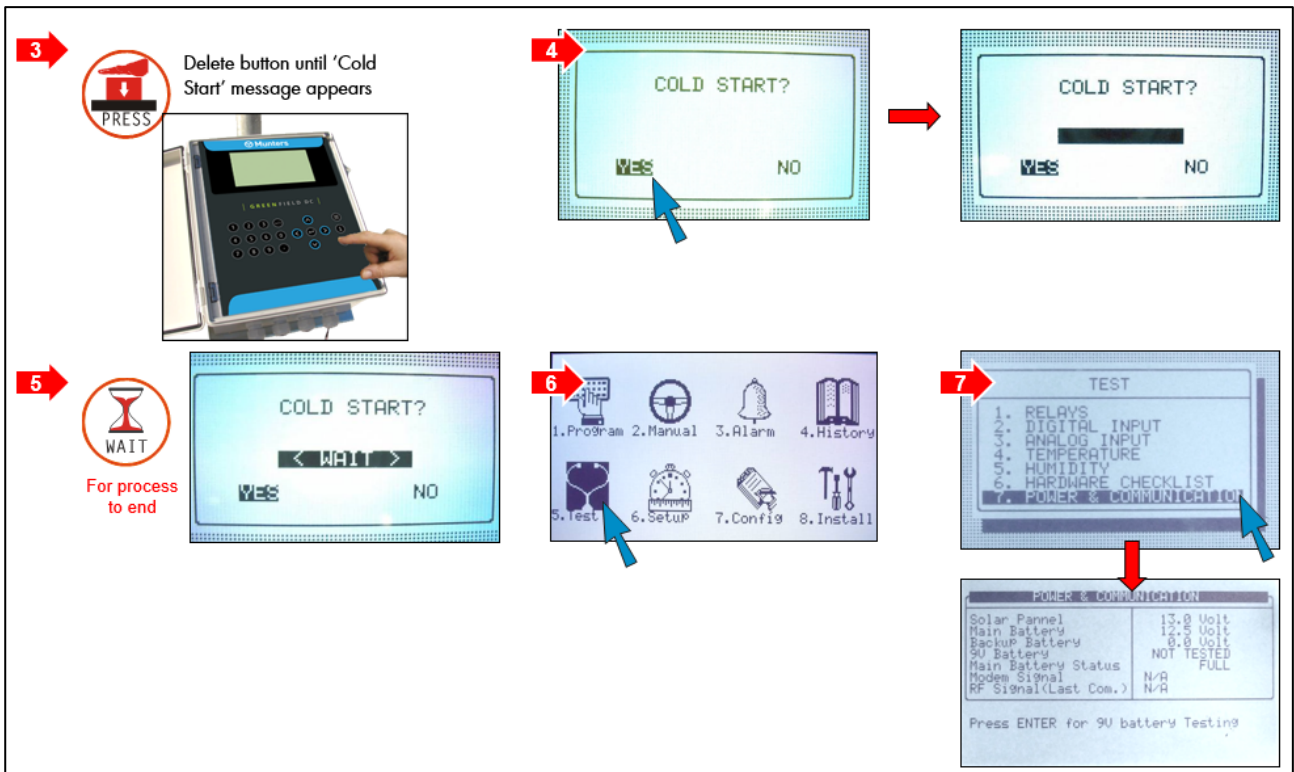

4.4 Set Language, Time and Date

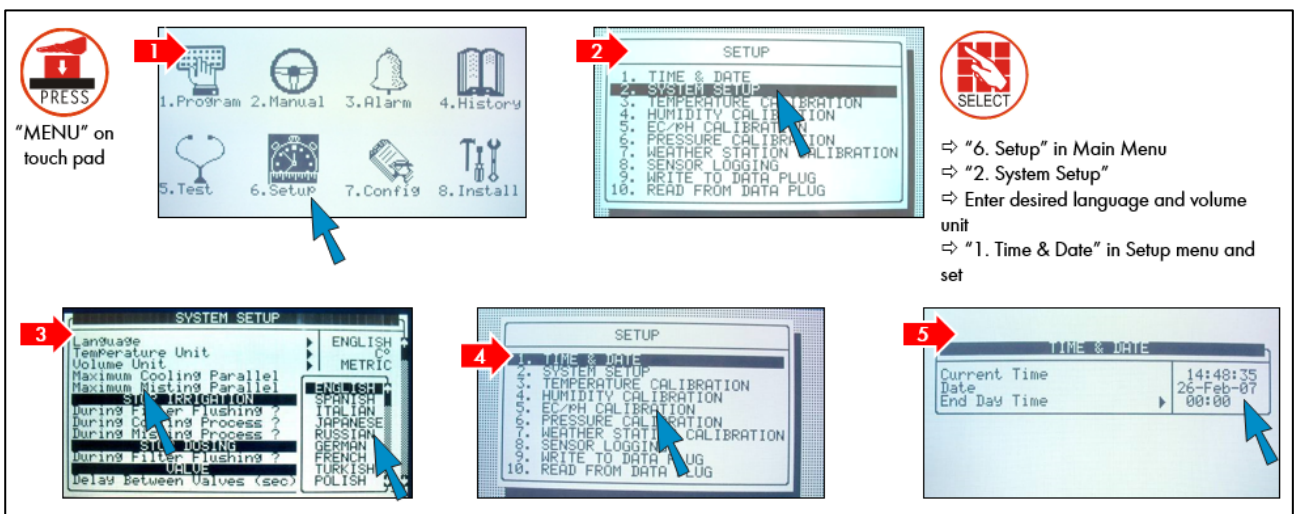

NOTE In any given menu, you may use arrow and ENTER keys on touch pad to make a selection or press the corresponding number and ENTER on touch pad as a short cut.

5 Electrical Installation

- Input/Output Layout
- Modular I/O Bus
- Controller Hardware Verification
- Solenoid Installation
- Output Terminal
- Input Terminals
- Digital Input Connections
- Analog Input Connections
- PC and Inter-Controller Communication

5.1 Input/Output Layout

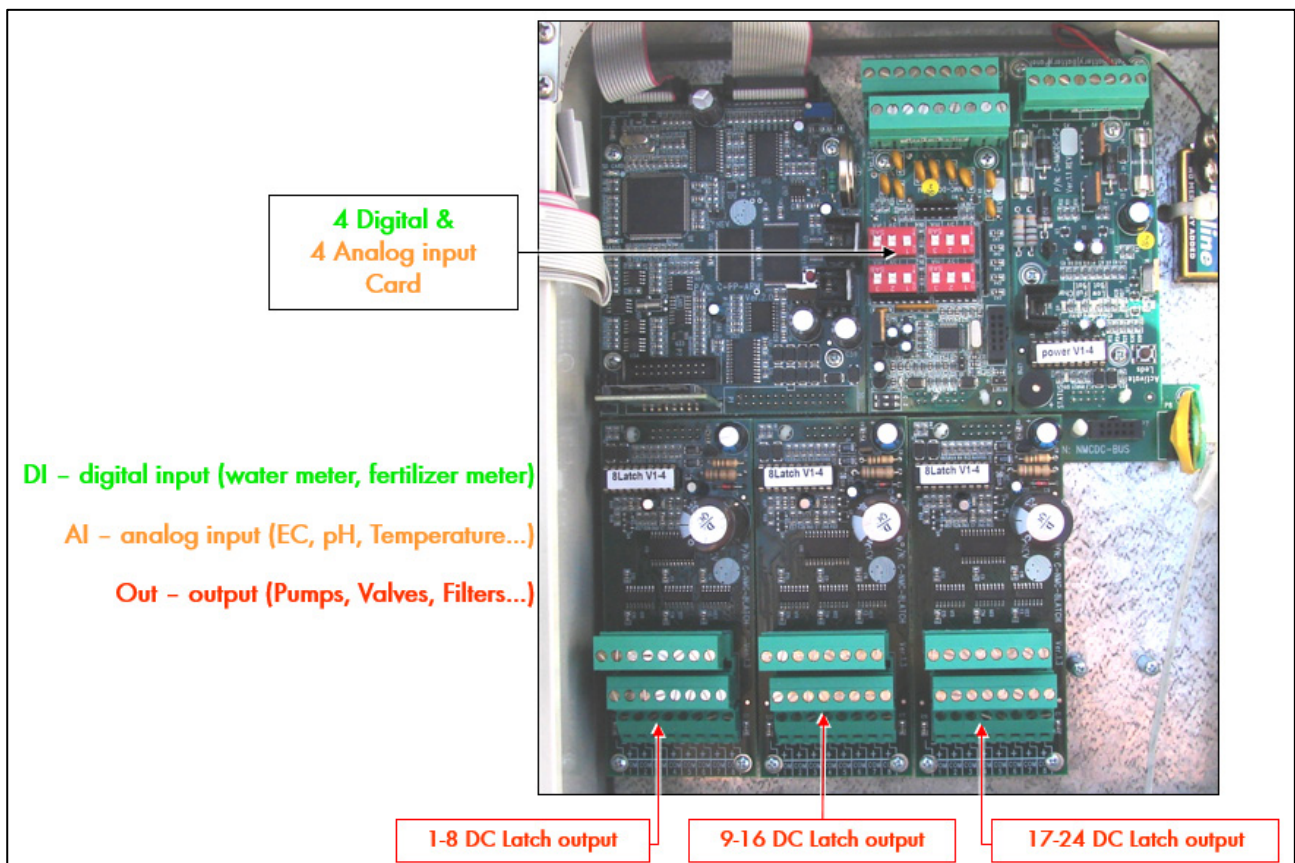

5.2 Modular I/O Bus

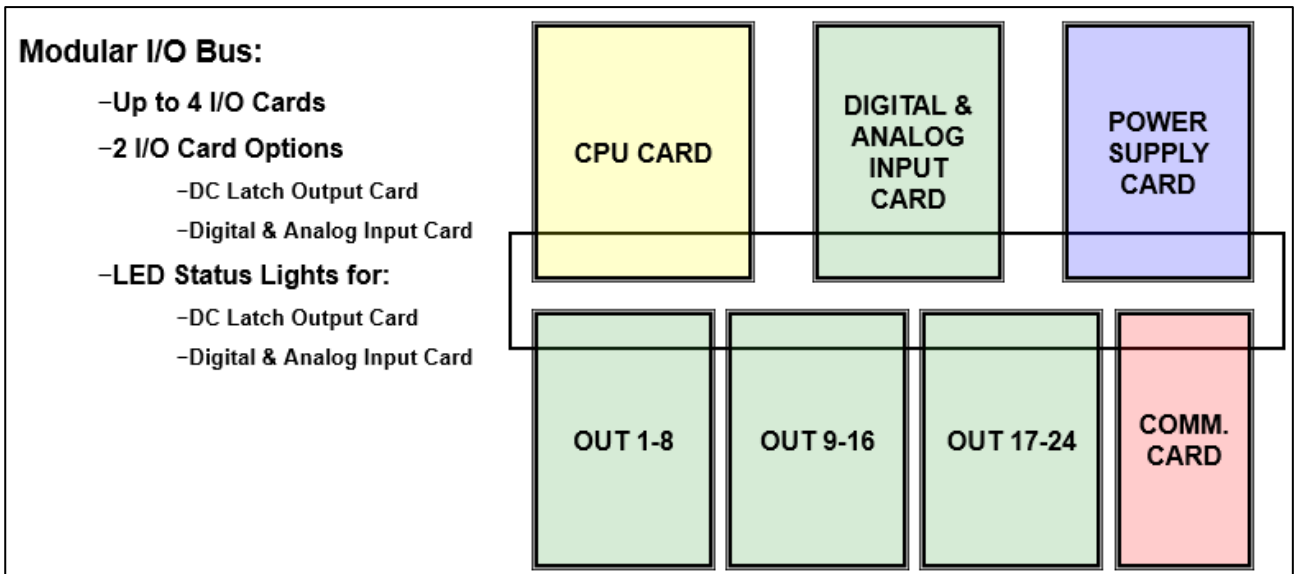

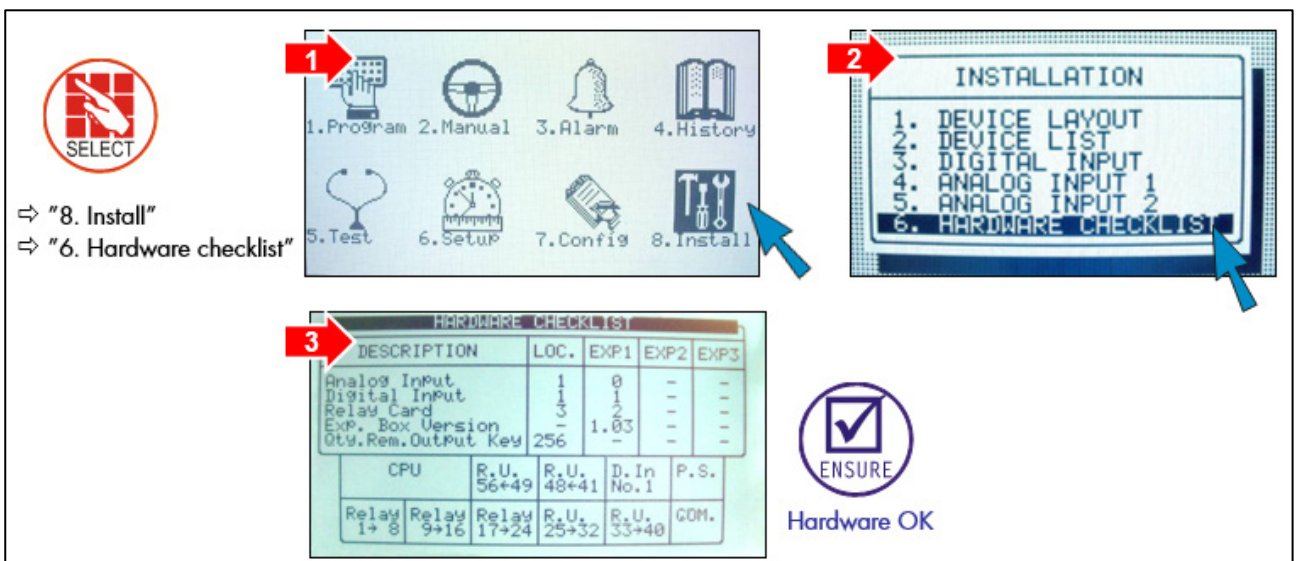

5.3 Controller Hardware Verification



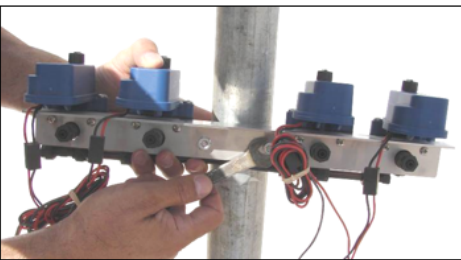

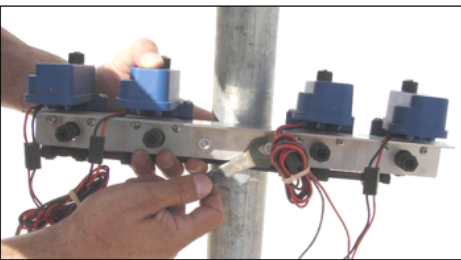
5.4 Solenoid Installation

1  Solenoids on pole 

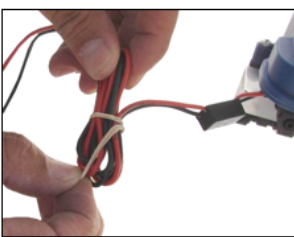
2  Washer and nut x2 

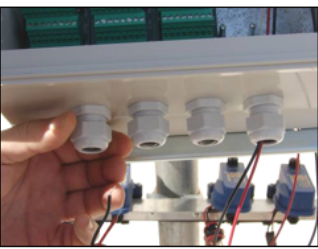

3  Rubber band 

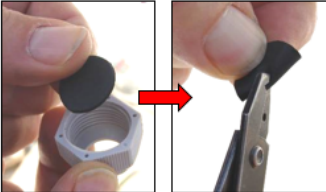
4  Gland cover 

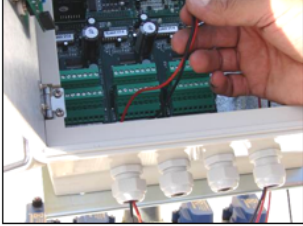
5  And CUT pad 

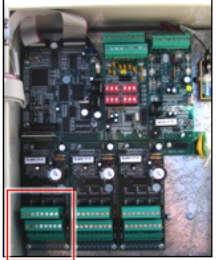
6  Wires through gland, pad and into the controller 

7  Terminal screw 

8  Previous step for all wires 

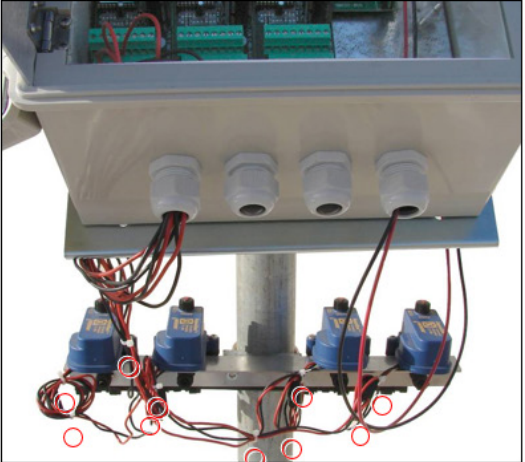
9  Wires using tie wraps x10 

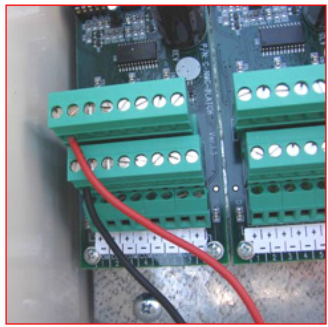
 Wires as shown 

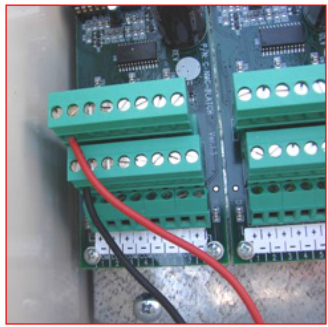
 Terminal screw 

5.5 Output Terminal

- 12V DC Latch Connection
- 12V DC Latch Hydraulic Connection

5.5.1 12V DC LATCH CONNECTION

CONNECT 12V DC Latch (Normally Open Connection)

- 1** **LOOSEN** Relevant screws
- 2** **INSERT**
 - Red wires on top terminal (+)
 - Black wires on middle terminal (-)
 - If there is a 3 wired solenoid, insert white wires on lower terminal (com)
- 3** **SCREW** Until wires are locked

CONNECT 12V DC Latch (Normally Closed Connection)

- INSERT**
 - Black wires on top terminal
 - Red wires on middle terminal
 - If there is a 3 wired solenoid, insert white wires on lower terminal

5.5.2 12V DC LATCH HYDRAULIC CONNECTION

- Normally Open/Closed

AquaTive^{Plus} DC

2 wire activated

Pressure range (NC, NO): 0-10 bar (0-140 psi)

Ambient temp. max: 60°C (140°F)

Filtration: 80 mesh min

Fluid temp. max: 60°C (140°F)

Voltage range: 12-30 VDC

Pulse width: min. 80, max. 500 ms

Plastic parts: Reinforced nylon

Command diaphragm: EPDM

Hydraulic outlet: 1/8" top

Valve anchoring: Two screws (self tapping) 10 x 1.5

Leads: 2 X AWG22 (120 cm)

Bracket material: Stainless steel 316

Hydraulic 3 ports (1/8" BSP): COM – command to valve A & B

Maximum distance from AquaTive^{Plus} to controller: 13.5VDC 80 ms 4700 µF

Cable gauge	diameter (mm)	cross section (mm ²)	max. distance (m)
20	0.8	0.5	150
17	1.1	1.0	240
15	1.4	1.5	380

Recommended working condition capacitor mode

Voltage (VDC)	Capacitor (µF)	Min. pulse (ms)
12-18	4700	80
18-28	3300	80
28-40	2200	80

Electrical connection

Two wires: orange + / black & white - common (changing wire connections will change NC to NO)

It is recommended to isolate wires connections from water to prevent corrosion.

AquaTive^{Plus} is compatible with most DC latch controllers MOTOROLA, ELDAR-GAL, TALGIL, PROGRES with two or three wire output (with 3-to-2 wire converter). For specific models, please contact your Metafim representative.

Catalog No.

Red - ON
Black - OFF
White - COM

No. of actuator (s)	Catalog No.
1 w/o brackets	35500-001900
1 w/ brackets	35500-002000
2 w/o brackets	35500-002100
3 w/ brackets	35500-002200
4 w/o brackets	35500-002300
5 w/ brackets	35500-002400
6 w/o brackets	35500-002500

Configuration 1* (standard)

Configuration 2 (not standard)

Configuration 1* (not standard)

Note: NC/NO is referring to the Hydraulic valve.

Electrical connections:

Red wires to top terminal (+)

Black wires to middle terminal (-)

If there is a third **white** wire, connect to lower terminal (com)

To change from Normally Open to Normally Closed:

-Reverse vent and pressure inputs as described in the picture above.

5.6 Input Terminals

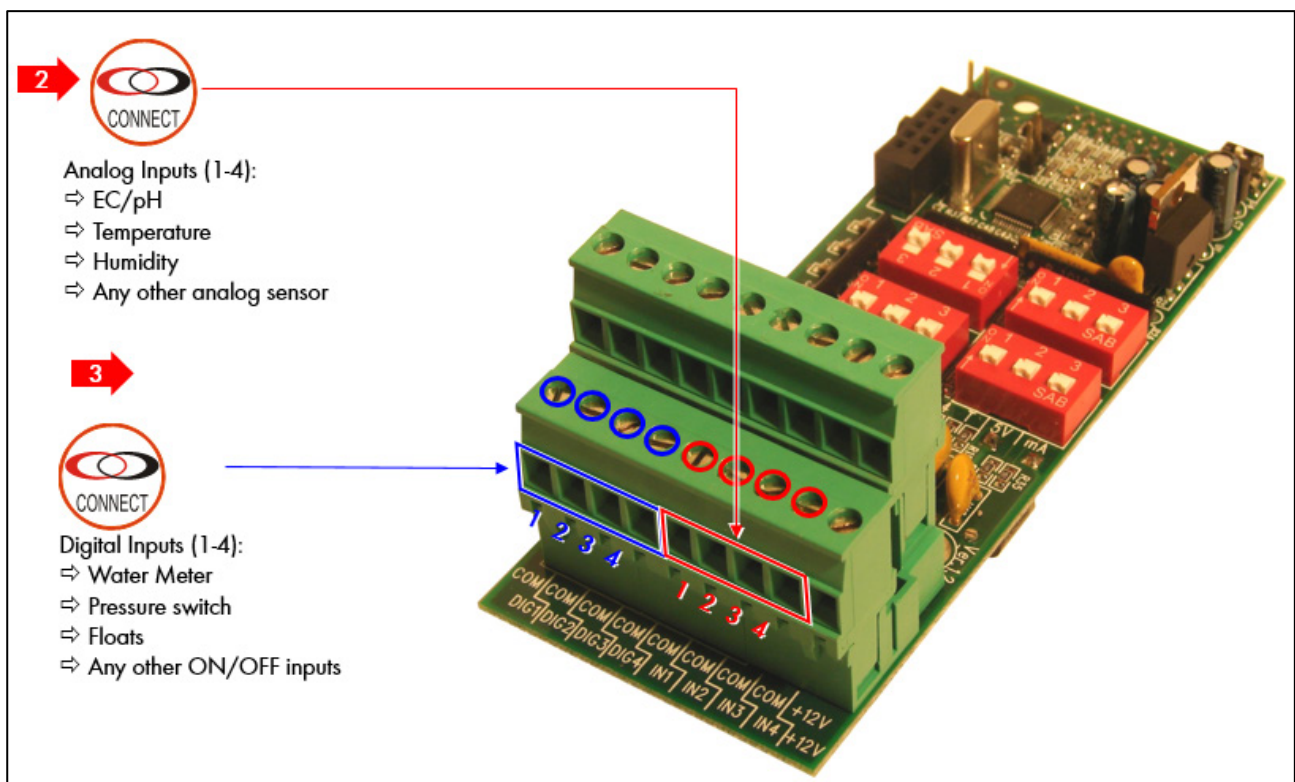
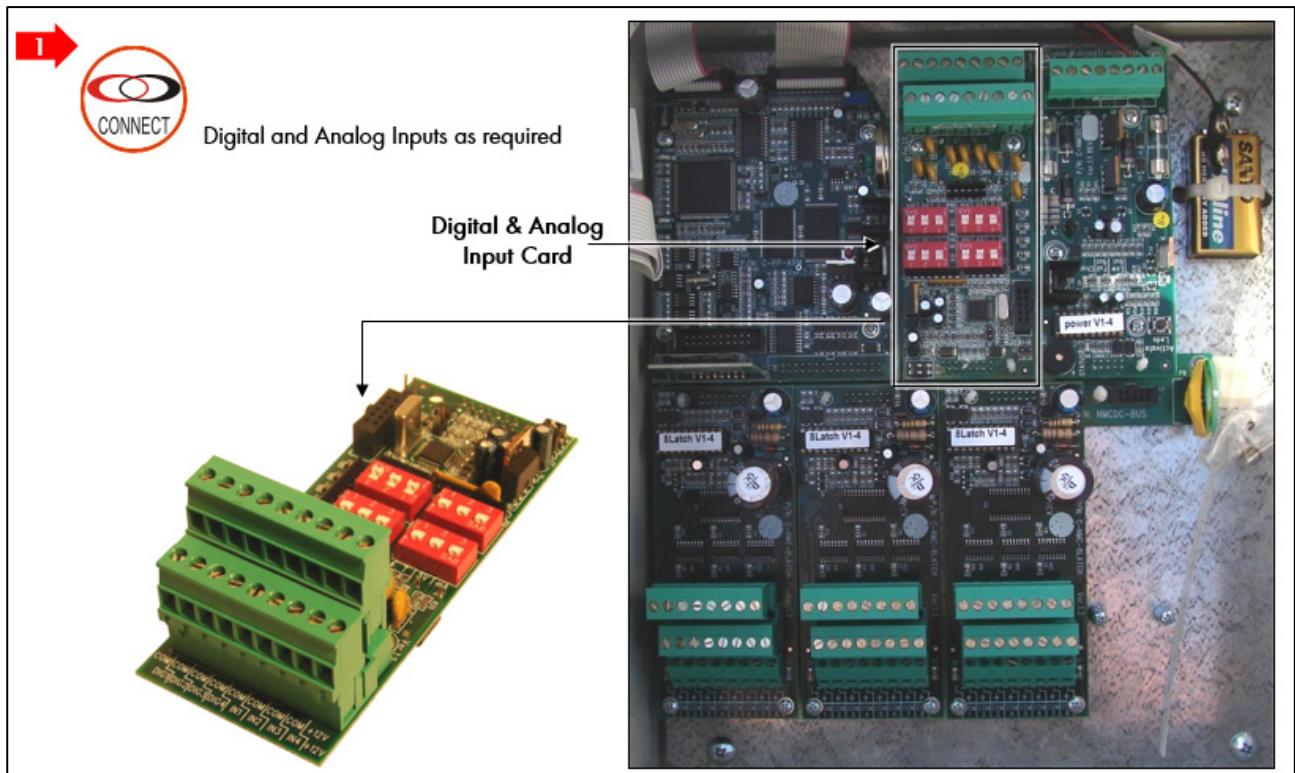

5.7 Digital Input Connections

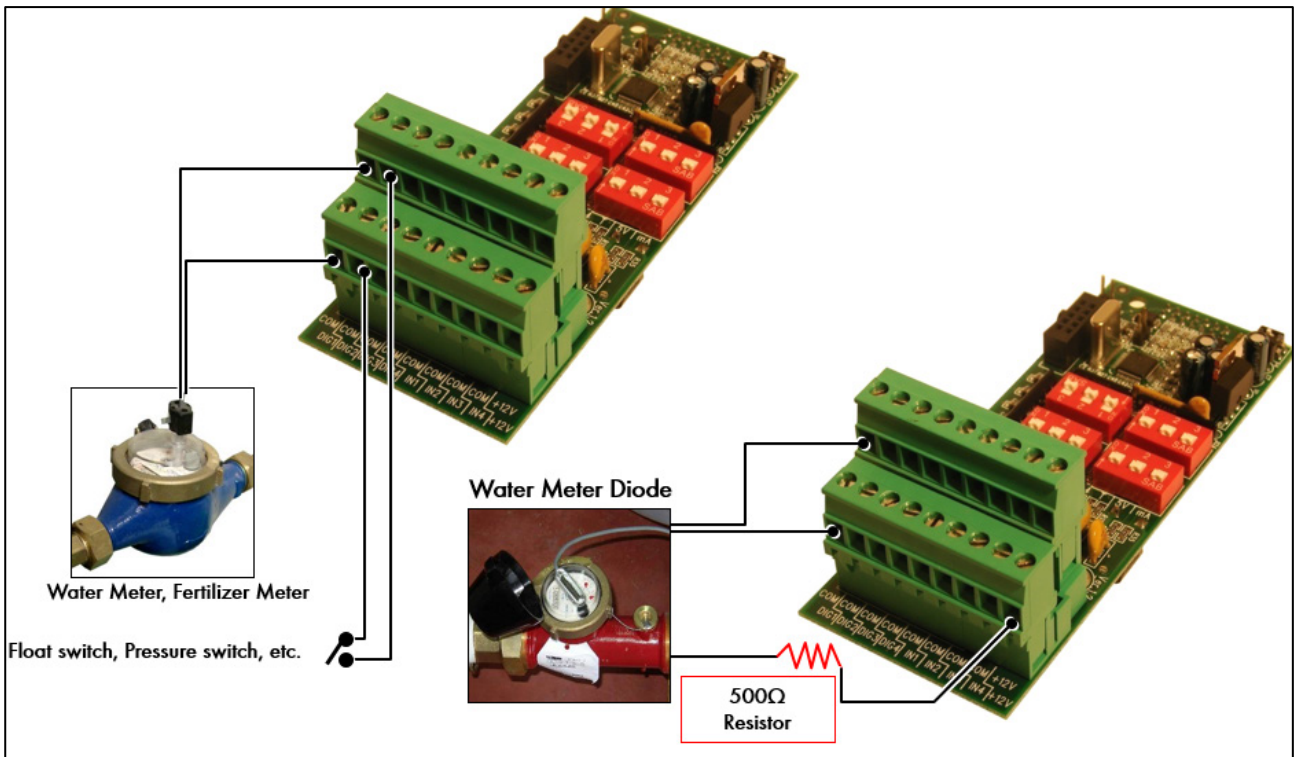

5.8 Analog Input Connections

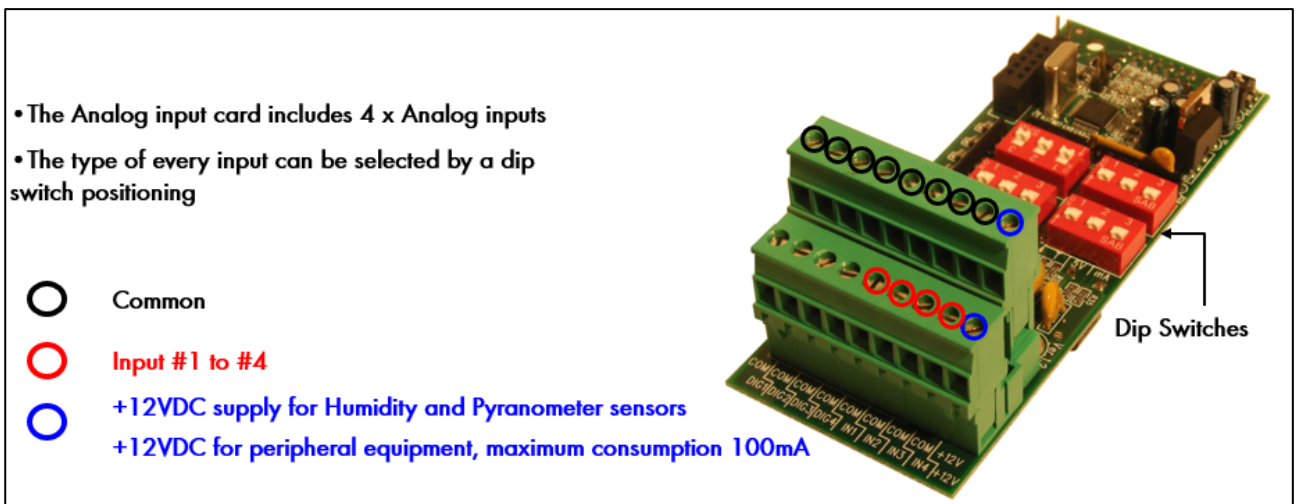

5.8.1 ANALOG INPUT DIP SWITCH SELECTIONS



Dip switch position for each input as needed according to location

Dip switch position	Sensor type
Temp	Temperature sensor (30k Ω)
0-5V	Humidity, Radiation, Pressure...
4-20mA	EC, pH

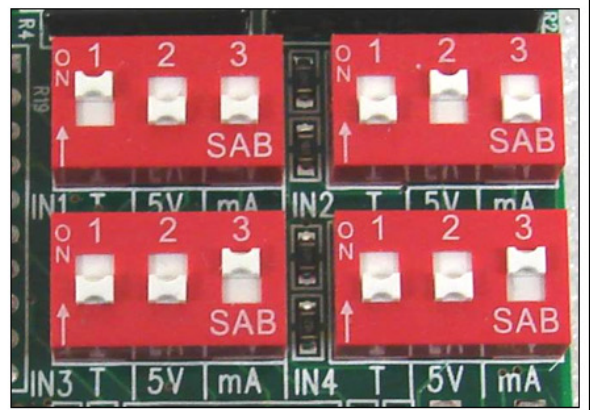

5.9 PC and Inter-Controller Communication

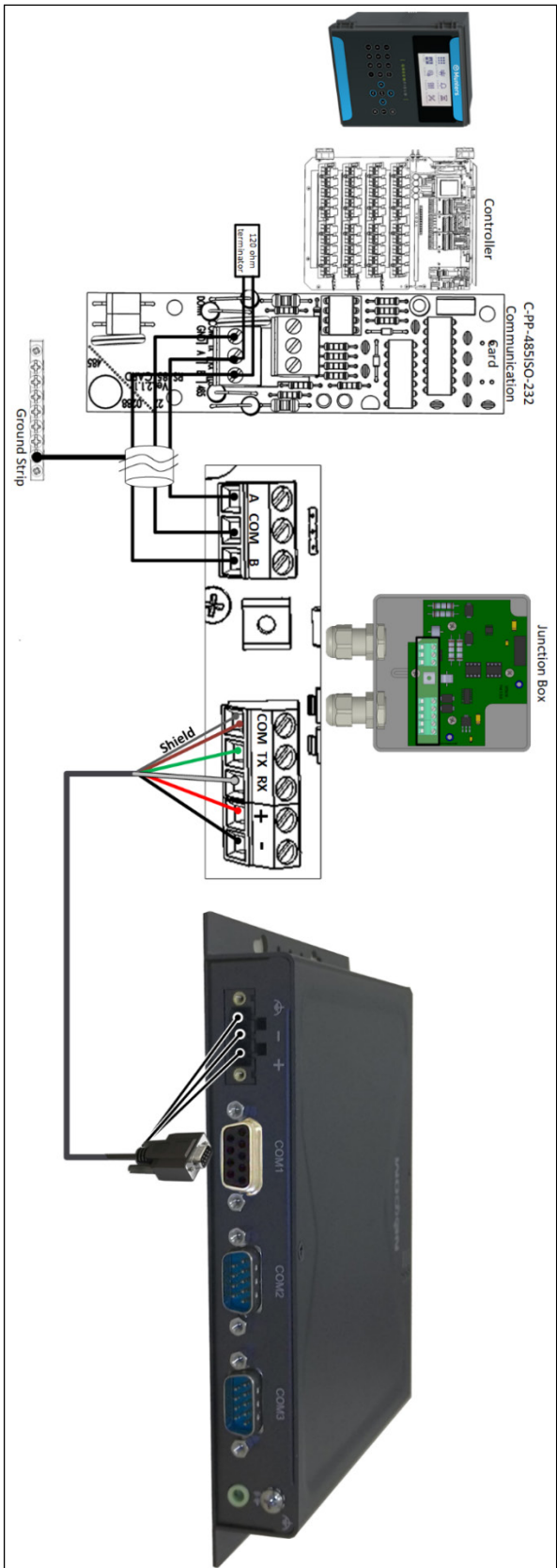

Figure 1: RS-485 Wiring to Comm-Box

NOTE Refer to the Comm-Box Manual on how to log-on to the Comm-Box and manage the controller.

6 Controller Set-Up

- Hardware Checklist
- Output Definition
- Digital Input Definition
- Analog Input Definition

6.1 Hardware Checklist

SELECT (Hand icon)

"7. Hardware Check list" in Installation menu

CHECK (Magnifying glass icon)

For Reference Only- overview of hardware check inputs and outputs

INSTALLATION

1. DEVICE LAYOUT
2. DEVICE LIST
3. DIGITAL INPUT
4. ANALOG INPUT 1
5. ANALOG INPUT 2
6. **HARDWARE CHECKLIST**

2 (Red arrow)

HARDWARE CHECKLIST				
DESCRIPTION	LOC.	EXP1	EXP2	EXP3
Analog Input	1	0	-	-
Digital Input	1	2	-	-
Relay Card	256	1,03	-	-
Exp. Box Version	-	-	-	-
Qty.Rem.Output Key	-	-	-	-

CPU	R.U.	R.U.	D. In	P.S.
	56+49	48+41	No.1	
Relay 1+8	Relay 9+16	Relay 17+24	Relay 25+32	Relay 33-40
				GDM.

1st 8 Latch card

2nd 8 Latch card

3rd 8 Latch card

Digital Input 1

6.2 Output Definition

SELECT (Hand icon)

⇒ "8. Install" in main menu and press ENTER

⇒ "1. Device Layout" and press ENTER

ENSURE (Checkmark icon)

Technician writes an I/O list

SELECT (Hand icon)

Define devices:
Ex. Valve 1 and 2
Relay 9 and 10 as Output 9 and 10
(Relay 9=1st Output of 2nd card...)

1 (Red arrow)

2 (Red arrow)

3 (Red arrow)

Press (+/-)



4 (Red arrow)

Press +/- to Toggle Advanced Mode

Press +/- to Toggle Advanced Mode

Press +/- to Toggle Advanced Mode

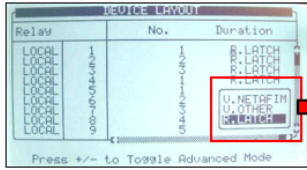
5  ENTER





- Munters solenoid has a pulse rate of 90 msec.
- Other solenoid has a pulse rate of 40 msec
- Relay Latch has a pulse rate of 15 msec..

NOTE: Choose the appropriate option depending on the type of solenoid.

 These steps for every output

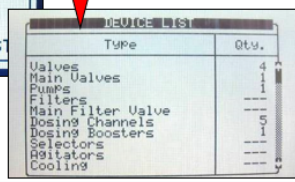
 "2. Device List" is read-only overview list of definitions for verification





Type	Qty.
Valves	4
Main Valves	1
Pumps	1
Filters	1
Main Filter Valve	1
Dosing Channels	1
Dosing Boosters	1
Selectors	1
agitators	1
Cooling	1

6.3 Digital Input Definition

 ⇒ "3. Digital Input 1" in Installation menu
⇒ Input 1 set definition

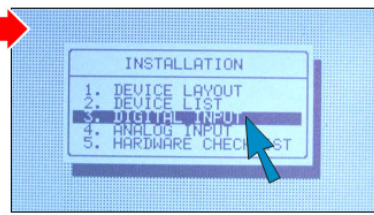
 Steps 2-4 for all Input definitions- according to technician and equipment in field

1 

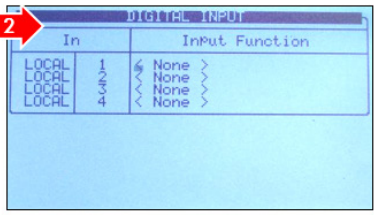
2 

In	Input Function
LOCAL	1 < None >
LOCAL	2 < None >
LOCAL	3 < None >
LOCAL	4 < None >

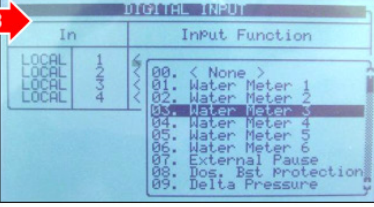
3 

In	Input Function
LOCAL	00. < None >
LOCAL	01. Water Meter 1
LOCAL	02. Water Meter 2
LOCAL	03. Water Meter 3
LOCAL	04. Water Meter 4
LOCAL	05. Water Meter 5
LOCAL	06. Water Meter 6
LOCAL	07. External Pause
LOCAL	08. Dos. Bst Protection
LOCAL	09. Delta Pressure

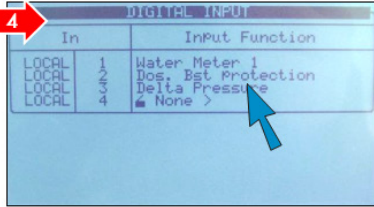
4 

In	Input Function
LOCAL	1 Water Meter 1
LOCAL	2 Dos. Bst Protection
LOCAL	3 Delta Pressure
LOCAL	4 < None >

6.4 Analog Input Definition



"5. Analog Input 1" in Installation menu



Pre-programmed at factory:

1. EC Sensor
2. PH Sensor



Channel 1 and enter additional sensors according to terminal and dip switch position



Previous step for all other analog input sensors

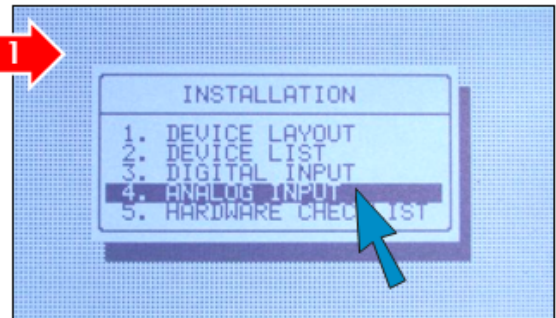

Channel	Input Function	No.
1	< None >	-
2	< None >	-
3	< None >	-
4	< None >	-

7 Controller Test Procedure

- Test Relays
- Digital Input Test
- Analog Input Test
- Power & Communication Test

7.1 Test Relays

NOTE In order to bring solenoid to Normally Open/Closed position either manually open and close each output, or switch controller off and back on again for automatic positioning.

 "5. Test" in Main Menu

 ⇒ "1. Relays" to test output devices in the field (dry test)
⇒ Highlight status, press ENTER, "MAN" appears
⇒ To end process press ENTER again

 For Irrigation valve test, send someone out in field with Walky-Talky to verify status

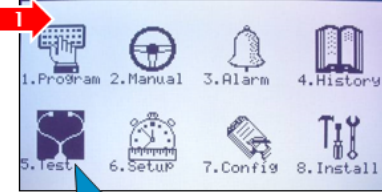
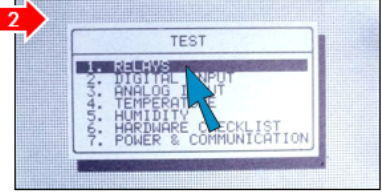
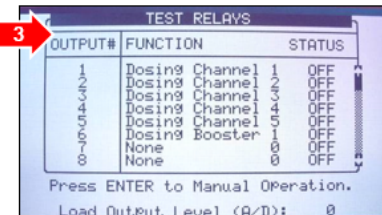
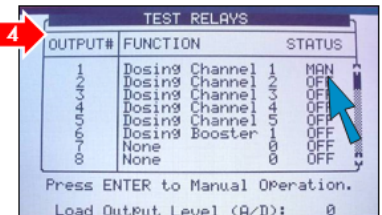
 Output Level (A/D): ≤300 A/D when all outputs are on.
If output level is above 300, see Troubleshooting Appendix B

OUTPUT#	FUNCTION	STATUS
1	Dosing Channel 1	OFF
2	Dosing Channel 2	OFF
3	Dosing Channel 3	OFF
4	Dosing Channel 4	OFF
5	Dosing Channel 5	OFF
6	Dosing Booster 1	OFF
7	None	0
8	None	0

OUTPUT#	FUNCTION	STATUS
1	Dosing Channel 1	MAN
2	Dosing Channel 2	OFF
3	Dosing Channel 3	OFF
4	Dosing Channel 4	OFF
5	Dosing Channel 5	OFF
6	Dosing Booster 1	OFF
7	None	0
8	None	0

7.2 Digital Input Test

SELECT "2. Digital Input" in Test menu

PERFORM Dry test- Get a pulse using magnet; attach magnet to get a pulse from the "read" of the cable

VERIFY ⇒ Water, fertilizer and any auxiliary meters: Count up 1-255
⇒ Delta pressure: 1= ON, 0= OFF

1

TEST

1. RELAYS

2. DIGITAL INPUT

3. ANALOG INPUT

4. TEMPERATURE

5. HUMIDITY

6. HARDWARE CHECKLIST

7. POWER & COMMUNICATION

2

Channel	Card No.1	Card No.2	Card No.3	Card No.4
1	0	0	0	0
2	0	0	0	0
3	N/A	0	0	0
4	N/A	0	0	0

3



7.3 Analog Input Test

SELECT "3. Analog Input" in Test menu
See Table 6.4 (Next Page)

SELECT "4. Temperature" or "5. Humidity"- values will be displayed

1

TEST

1. RELAYS

2. DIGITAL INPUT

3. ANALOG INPUT

4. TEMPERATURE

5. HUMIDITY

6. HARDWARE CHECKLIST

7. POWER & COMMUNICATION

2

ANALOG INPUT

Channel	Value
1	0
2	1023
3	1023
4	1023

3

TEMPERATURE

No.	Value
1	23.8
2	-----
3	-----
4	-----

4

HUMIDITY

No.	Value
1	58.1
2	-----
3	-----
4	-----

Channel	Value
1	0
2	1023
3	1023
4	1023

Sensor type	Description
pH sensor	pH = 0: A/D = 205
	pH = 7.0: A/D = 615
	pH = 14.0: A/D = 1023
EC sensor	EC = 0: A/D = 205

Sensor type	Description
	EC = 2.0: A/D = 370
	EC = 10.0: A/D = 1024
Humidity sensor	RH% = 0: A/D = 0
	RH% = 50: A/D = 308
	RH% = 100: A/D = 620
Temp sensor	T°C = 0: A/D = 768
	T°C = 25: A/D = 489
	T°C = 50: A/D = 250

7.4 Power & Communication Test

1 "7. Power & Communication" in Test menu

2

3 ENTER

Solar Panel ≈ 13.0 Volts
Main Battery ≈ 12.5 Volts
9V Battery ≈ 9.9 Volts
Main Battery Status = FULL

4

8 System Configuration Procedure

- Device Delay Configuration
- Pump Station Configuration
- Valve Configuration
- Valve Flow Rate
- Water Meter
- Dosing Channel Configuration
- Dosing Configuration
- EC/pH Sensor Range
- History Resolution
- System Nutrigation™
- Data Plug

8.1 Device Delay Configuration

 Irrigation system and controller configuration

 ⇒ "7. Config" in Main Menu
⇒ "1. Device Delay Configuration"
⇒ Enter delay values. See table below.

1 →



2 →

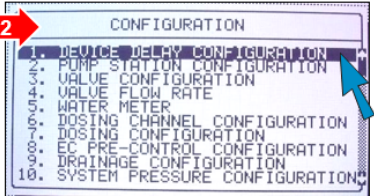

3 →

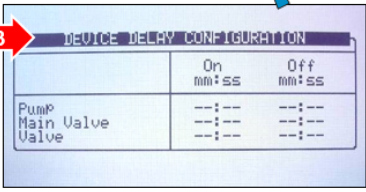

	On mm:ss	Off mm:ss
Pump	--:--	--:--
Main Valve	--:--	--:--
Valve	--:--	--:--

4 →

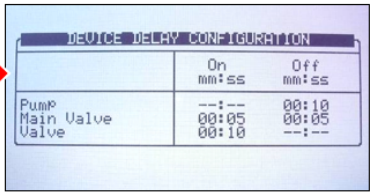

	On mm:ss	Off mm:ss
Pump	--:--	00:10
Main Valve	00:05	00:05
Valve	00:10	--:--

NMC Device delay

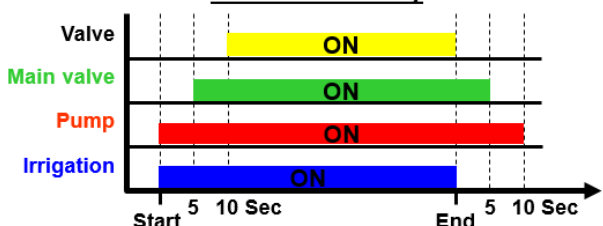

Start 5 10 Sec End 5 10 Sec

NOTE Settings in the graph below are for example only.

8.2 Pump Station Configuration

 ⇒ "2. Pump Station Configuration"
⇒ Define capacity of main pump

1

CONFIGURATION

1. DEVICE DELAY CONFIGURATION
2. PUMP STATION CONFIGURATION
3. VALVE CONFIGURATION
4. VALVE FLOW RATE
5. WATER METER
6. DOSING CHANNEL CONFIGURATION
7. EC PRE-CONTROL CONFIGURATION
8. DRAINAGE CONFIGURATION
9. SYSTEM PRESSURE CONFIGURATION

2

PUMP STATION CONFIGURATION

Pump No.	Capacity m ³ /h	Stability mm:ss	Off Delay mm:ss
1	100.000	--:--	--:--

3

PUMP STATION CONFIGURATION

Pump No.	Stability mm:ss	Off Delay mm:ss	Station
1	--:--	--:--	NO

NOTE : If there is more than 1 pump, please refer to Green Field DC Advanced Settings.

8.3 Valve Configuration

 ⇒ "3. Valve Configuration"
⇒ Allocate pump, main valve and water meter
(Note: If there is more than 1 pump, refer to NMC-DC User Manual)

1

CONFIGURATION

1. DEVICE DELAY CONFIGURATION
2. PUMP STATION CONFIGURATION
3. VALVE CONFIGURATION
4. VALVE FLOW RATE
5. WATER METER
6. DOSING CHANNEL CONFIGURATION
7. EC PRE-CONTROL CONFIGURATION
8. DRAINAGE CONFIGURATION
9. SYSTEM PRESSURE CONFIGURATION

2

VALVE CONFIGURATION

Valve No.	Pump	Main Valve	Water Meter	Drain Meter
1	Pump 1	1	-	-
2	Pump 1	1	<NONE>	-
3	Pump 1	1	Pump 1	-
4	Pump 1	1	Station	-

8.4 Valve Flow Rate

 ⇒ "4. Valve Flow Rate"
⇒ Define exact flow consumption of every valve:
Technician must calculate formula:
[Drippers/lateral x dripper capacity (liters/hr) x # of laterals/valve] ÷ 1000 = nominal flow of valve (m³/hr)
⇒ Set Min./Max. flow rate limits per valve for alarm (already defined as 25% by default)

1

VALVE FLOW RATE

Valve No.	Nominal m ³ /h	Minimum m ³ /h	Maximum m ³ /h
1	80.000	60.000	100.000
2	90.000	67.500	112.500
3	85.000	63.750	106.250
4	100.000	75.000	125.000

Drippers / Lateral

Number of laterals

Irrigation valve

Dripper capacity

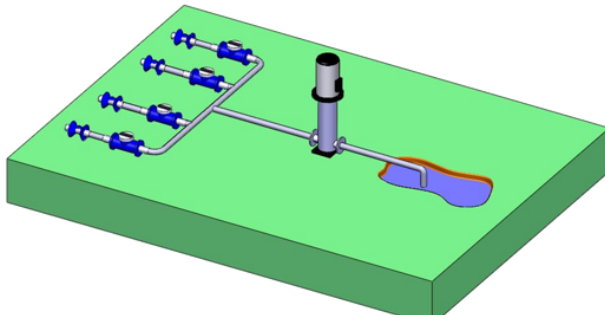

NOTE In case of use of multiple water meters or drain meter, please refer to Advanced Settings on page 62/64.

8.5 Water Meter

SELECT

⇒ "5. Water Meter"
⇒ Define resolution of water meter-
See label on water meter as shown in
Step 2

CHECK

If there is no label, check data sheet
supplied with the meter.

1

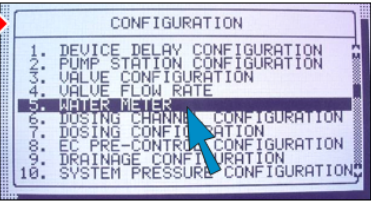

2



3

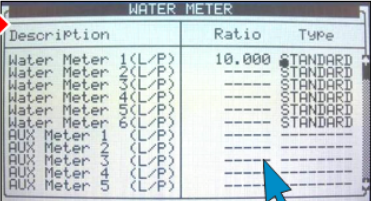

Description	Ratio	Type
Water Meter 1(L/P)	10.000	STANDARD
Water Meter 2(L/P)	-----	STANDARD
Water Meter 3(L/P)	-----	STANDARD
Water Meter 4(L/P)	-----	STANDARD
Water Meter 5(L/P)	-----	STANDARD
Water Meter 6(L/P)	-----	STANDARD
AUX Meter 1 (L/P)	-----	-----
AUX Meter 2 (L/P)	-----	-----
AUX Meter 3 (L/P)	-----	-----
AUX Meter 4 (L/P)	-----	-----
AUX Meter 5 (L/P)	-----	-----

NOTE If there is more than 1 water meter, please refer to Green Field DC Advanced Settings

8.6 Dosing Channel Configuration

SELECT

⇒ "6. Dosing channel Configuration"
⇒ Define flow rate of every Venturi
⇒ Define channels 1-4=EC
⇒ Define channel 5=Acid

1

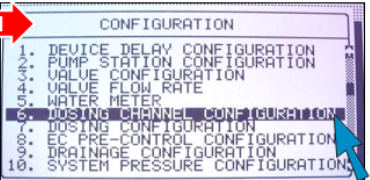

2

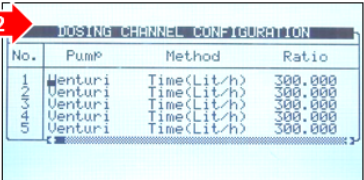

3

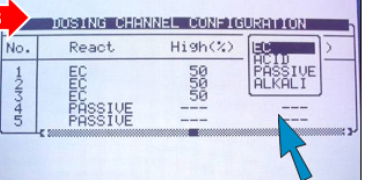

4

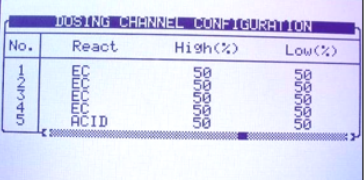

No.	Pump	Method	Ratio
1	Venturi	Time(Lit/h)	300.000
2	Venturi	Time(Lit/h)	300.000
3	Venturi	Time(Lit/h)	300.000
4	Venturi	Time(Lit/h)	300.000
5	Venturi	Time(Lit/h)	300.000

No.	React	High(%)	Low(%)
1	EC	50	50
2	EC	50	50
3	PASSIVE	---	---
4	PASSIVE	---	---
5	ACID	---	---

No.	React	High(%)	Low(%)
1	EC	50	50
2	EC	50	50
3	PASSIVE	---	---
4	PASSIVE	---	---
5	ACID	50	50

NOTE In case of different dosing pump (electric) or setting (fertilizer meter), please refer to Green Field DC Advanced Settings

8.7 Dosing Configuration

SELECT

⇒ "7. Dosing Configuration"
⇒ EC and PH Control and Alarms to "Yes"
⇒ Set Min. On Time to 0.8≤2.0 seconds
⇒ Set Min. Off Time to 0.8≤2.0 seconds
⇒ To set Control Cycle, run system and measure time
in seconds it takes to see reaction of EC/PH meter
⇒ Set dosing Booster Delay to 10 seconds

1

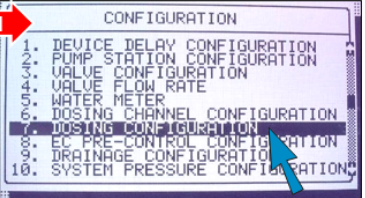

2

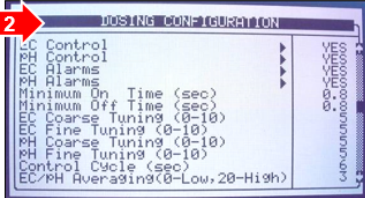

3

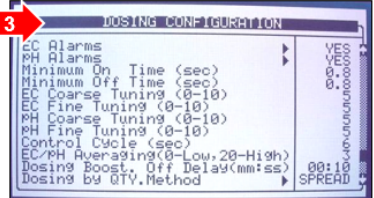

Parameter	Value
EC Control	Yes
PH Control	Yes
EC Alarms	Yes
PH Alarms	Yes
Minimum On Time (sec)	0.8
Minimum Off Time (sec)	0.8
EC Coarse Tuning (0-10)	5
PH Coarse Tuning (0-10)	5
EC Fine Tuning (0-10)	5
PH Fine Tuning (0-10)	5
Control Cycle (sec)	10
EC/PH Averaging(0-Low,20-High)	10
Dosing Boost. Off Delay(mm:ss)	00:10
Dosing by DTV.Method	SPREAD

Parameter	Value
EC Alarms	Yes
PH Alarms	Yes
Minimum On Time (sec)	0.8
Minimum Off Time (sec)	0.8
EC Coarse Tuning (0-10)	5
PH Coarse Tuning (0-10)	5
EC Fine Tuning (0-10)	5
PH Fine Tuning (0-10)	5
Control Cycle (sec)	10
EC/PH Averaging(0-Low,20-High)	10
Dosing Boost. Off Delay(mm:ss)	00:10
Dosing by DTV.Method	SPREAD

8.8 EC/pH Sensor Range

 ⇒ "12. EC/PH Configuration"
⇒ Leave as is

1 →

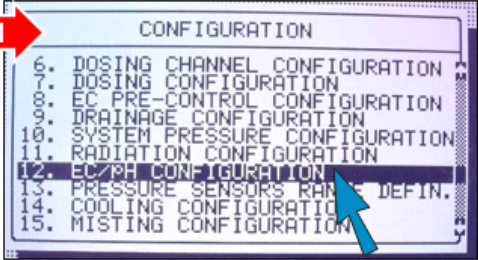

2 →

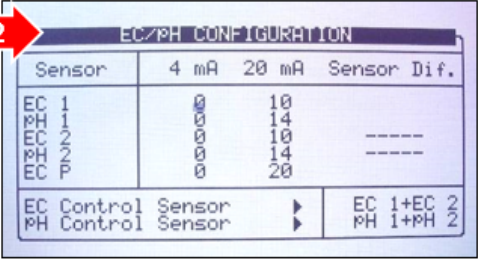

Sensor	4 mA	20 mA	Sensor Dif.
EC 1	0	10	
PH 1	0	14	
EC 2	0	10	----
PH 2	0	14	----
EC P	0	20	

EC Control Sensor ▶ EC 1+EC 2
PH Control Sensor ▶ PH 1+PH 2

NOTE When using multiple EC or pH sensors, please refer to Green Field DC Advanced Settings.

8.9 History Resolution

 Program how often computer should collect sensor data. (Keep in mind that lower resolution will quickly fill the memory and overwrite the old data - See the User Manual)

1 →



2 →

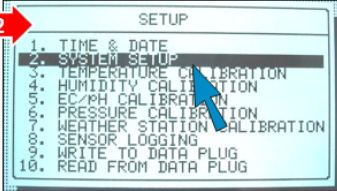

3 →

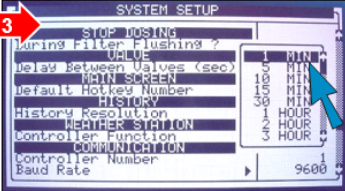

STOP DOSING
During Filter Flushing ?
Delay Between Valves (sec)
MAIN SCREEN
Default Hotkey Number
History Resolution
WEATHER STATION
Controller Function
COMMUNICATION
Controller Number
Baud Rate

5 MIN
10 MIN
15 MIN
30 MIN
1 HOUR
2 HOUR
3 HOUR
1
9600

NOTE For more details on system setup, please refer to Green Field DC Advanced Settings.

8.10 System Nutrigation™

- Check EC/pH is on Target



ENSURE

Know limits of irrigation system. Calculate max. allowed injection:
 (Dosing channel suction flow ÷ average flow rate from field) X 0.8 =
 Max. injection quantity (lit/m³, USA: Gallon/1000 gallon.)

1



SELECT

2

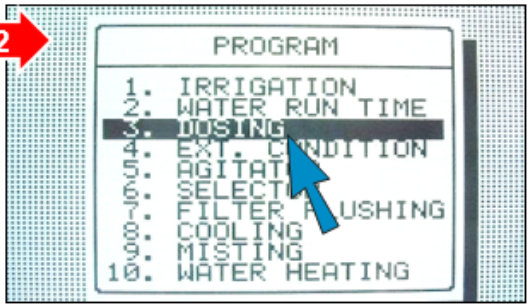

3

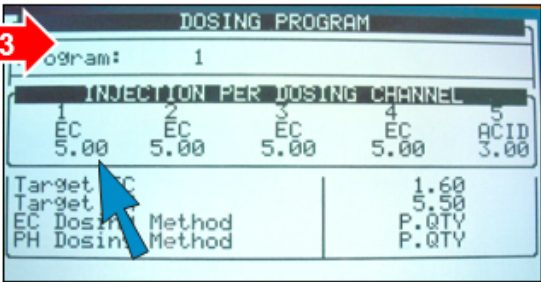

Enter desired amount of fertilizer to inject per dosing channel in l/m³ (USA: Gallon/1000 gallon)

4

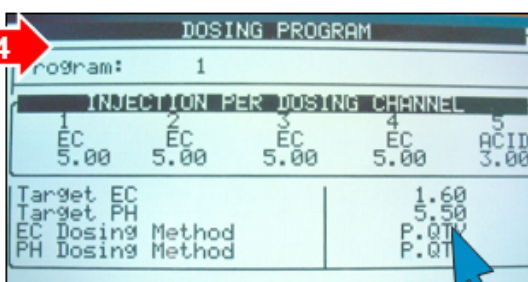

Enter desired target EC/pH levels

8.10.1 SIMULATION

ATTENTION
Use protective equipment, gloves and goggles when handling fertilizers, acid and other chemicals!



- ⇒ 10 liters of water in bucket
- ⇒ Inject 50 ml of fertilizer from each tank
- ⇒ Inject 30 ml of acid
- ⇒ Mix until acid and fertilizer is dissolved



- ⇒ EC and pH levels.
- ⇒ Results should be relatively close to desired target.
- ⇒ Deviation of ≤ 0.5 from target is allowed.

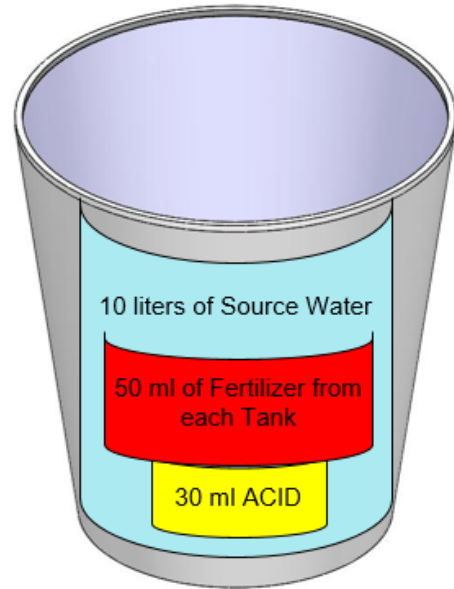

8.10.2 WATER RUN TIME

1

SELECT

2

3

Method	Water	Before	After
1 TIME	00:10:00	00:00:00	00:00:00
2 QTY.	0.000	0.000	0.000
3 QTY.	0.000	0.000	0.000
4 QTY.	0.000	0.000	0.000
5 QTY.	0.000	0.000	0.000
6 QTY.	0.000	0.000	0.000
7 QTY.	0.000	0.000	0.000
8 QTY.	0.000	0.000	0.000
9 QTY.	0.000	0.000	0.000
10 QTY.	0.000	0.000	0.000
11 QTY.	0.000	0.000	0.000

Enter water run time or quantity

8.10.3 START/STOP VALVE

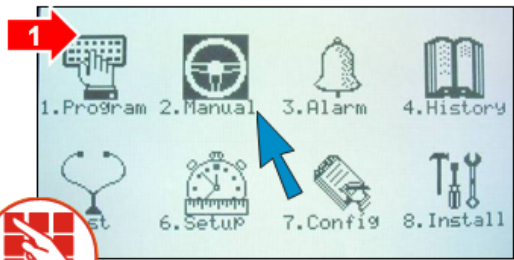

1. Program 2. Manual 3. Alarm 4. History
5. Test 6. Setup 7. Config 8. Install

SELECT

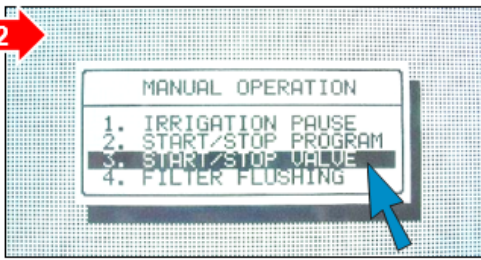

MANUAL OPERATION
1. IRRIGATION PAUSE
2. START/STOP PROGRAM
3. START/STOP VALVE
4. FILTER FLUSHING

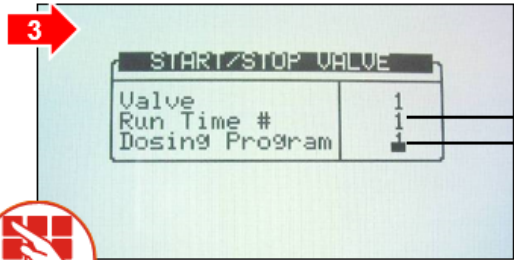

START/STOP VALVE

Valve	1
Run Time #	1
Dosing Program	1

SELECT

Run Time Program (1)
Dosing Program (1)

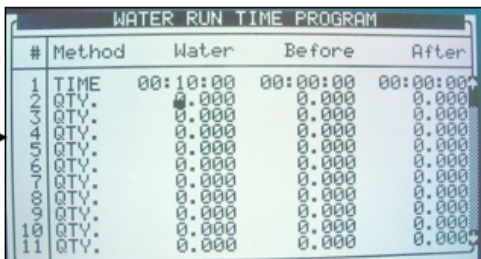

#	Method	Water	Before	After
1	TIME	00:10:00	00:00:00	00:00:00
2	QTY.	0.000	0.000	0.000
3	QTY.	0.000	0.000	0.000
4	QTY.	0.000	0.000	0.000
5	QTY.	0.000	0.000	0.000
6	QTY.	0.000	0.000	0.000
7	QTY.	0.000	0.000	0.000
8	QTY.	0.000	0.000	0.000
9	QTY.	0.000	0.000	0.000
10	QTY.	0.000	0.000	0.000
11	QTY.	0.000	0.000	0.000

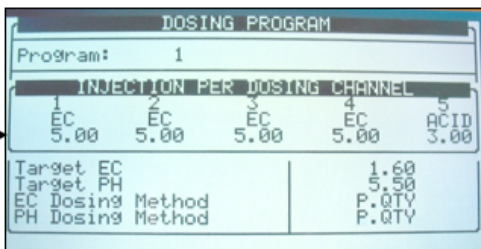

DOSING PROGRAM

Program: 1

INJECTION PER DOSING CHANNEL				
1	2	3	4	5
EC	EC	EC	EC	ACID
5.00	5.00	5.00	5.00	3.00

Target EC 1.60
Target PH 5.50
EC Dosing Method P.QTY
PH Dosing Method P.QTY

8.11 Data Plug

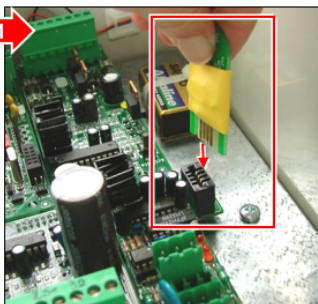

1

INSERT

Data plug into terminal

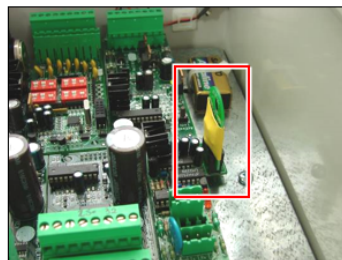
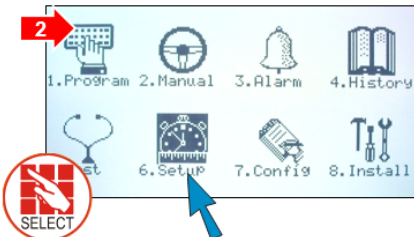
1. Program 2. Manual 3. Alarm 4. History
5. Test 6. Setup 7. Config 8. Install

SELECT

System is idle and not in process before "Write to Data Plug"

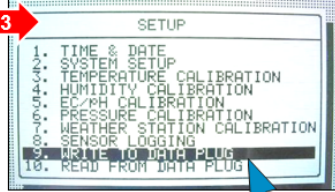

SETUP

1. TIME & DATE
2. SYSTEM SETUP
3. TEMPERATURE CALIBRATION
4. HUMIDITY CALIBRATION
5. EC/RH CALIBRATION
6. PRESSURE CALIBRATION
7. WEATHER STATION CALIBRATION
8. SENSOR LOGGING
9. WRITE TO DATA PLUG
10. READ FROM DATA PLUG

3

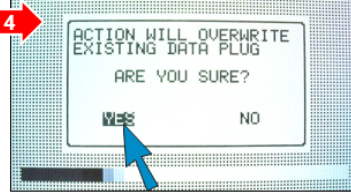

ACTION WILL OVERWRITE EXISTING DATA PLUG
ARE YOU SURE?

YES NO

4

REMOVE

Data Plug from terminal at end of process

5

9 Program

- Irrigation
- Water Run Time
- Dosing
- EXT. Condition
- Agitator
- Selector
- Filter Flushing
- Cooling
- Misting
- Water Heating

In the Main Menu screen, place the cursor on the program icon and press , or press

'1' to enter the Program menu.



NOTE To enter any of the menus, press the corresponding numeric key or scroll to the desired item using the up/down arrow keys and press ENTER: a new window will appear. The first menu under Program is Irrigation.

9.1 Irrigation

The Irrigation Program screen includes all the settings for configuring automatic irrigation start. It depends heavily on the Water Run Time and dosing program screens; therefore it is recommended to configure these screens before irrigation takes place.

The Green Field DC consists of 15 irrigation programs.

- Program: Select a program by entering the program number and confirm by pressing ENTER.
- Priority - Priority determines the order in which programs will take place. If start time is the same, higher priority programs come first. Higher priority programs do not stop currently operative programs.

If start time and priority are the same, irrigation programs with a lower number are executed first. Priority ranges are between 0 and 15, 15 being the highest (See Green Field DC Irrigation: Part 2 > Priority specifications for further information).

- Const / Daily / Cond. / Rad Sum / VPD Sum:
 - CONST.: Increase or decrease the amount of water for all valves included in this program. 0% means the quantities will be as specified in the Water Run Time program, 100% will be twice the amount and -50% will be half the amount specified in the Water Run Time Program.

To decrease enter the required percentage of change, press the +/- key and then confirm with the ENTER key.

The percentage of change will be active until you specify otherwise.

- DAILY: Increase or decrease the amount of water for all valves included in this program. 0% means the quantities will be as specified in the Water Run Time program, 100% will be twice the amount and -50% will be half the amount specified in the Water Run Time Program.

To decrease, enter the required percentage of change, press +/- key and then confirm with the ENTER key.

The percentage of change will be active only for the present day and will change automatically back to zero on End Day time.

NOTE CONST. % and DAILY % does not change Quantity / time of water before and water after settings, nor dosing quantities.

NOTE Note that when setting watering program and using 'Spread' the percentage affects not only the water but also the dosing.

- Cond.: Specify whether the Condition program can trigger irrigations, and choose a Condition program to start/stop irrigations. Irrigations will be started and stopped according to the settings of the relevant Condition program (see the EXT. CONDITION, on page 35 program, for additional information). If irrigation is not triggered due to Condition program until Max time has elapsed irrigation will be performed due to Max time.

When choosing Condition, the screen will be split in two. To view the day sequence, press the Down arrow when the cursor is placed on the bottom of the screen.

The Condition program has the third priority after active irrigation and uncompleted irrigation (See Green Field DC Irrigation: Part 2 > Priority specifications for further information).

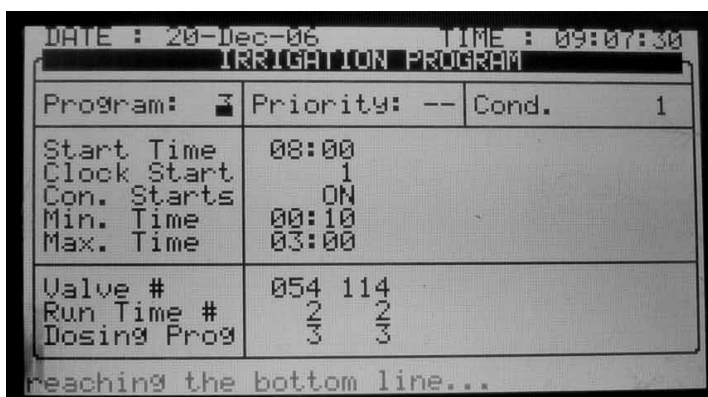

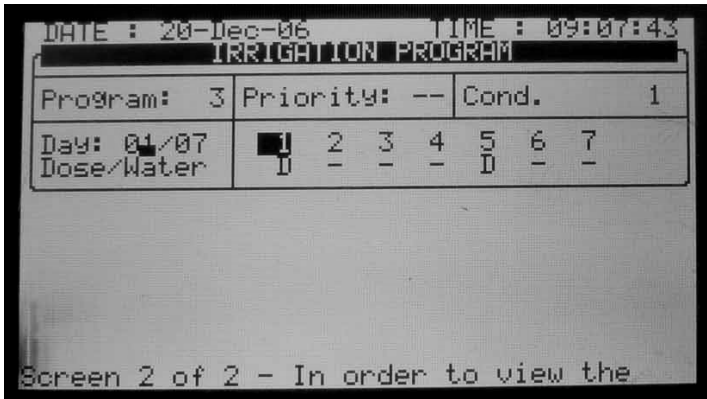

NOTE It is impossible to set the same Condition program for two different programs.

- Rad Sum / VPD Sum: Choose whether irrigations can be triggered by the radiation or VPD sum. The specific Rad Sum trigger is specified per period (see [Rad Sum Li.](#)). If irrigation is not triggered due to Rad/VPD Sum until Max time has elapsed irrigation will be performed due to Max time.

DATE : 1-May-12 TIME : 10:12:09			
IRRIGATION PROGRAM			
Program: 2	Priority: --	Rad Sum	
Start Time	07:00	12:00	16:00
Clock Start	1	--	--
Rad Sum Li.	200	--	100
Min. Time	01:00	00:30	--:--
Max. Time	02:00	--:--	--:--
Valve #	001	051+052	115 255
Run Time #	1	2 2	2 --
Dosing Prog	1	2 2	3 2

Screen 1 of 3 - In order to view the

DATE : 1-May-12 TIME : 10:12:09					
IRRIGATION PROGRAM					
Program: 2	Priority: --	Rad Sum			
Day: 04/06	1	2	3	4	5 6
Dose / Water	D	-	D	W	D W

Screen 2 of 3 - In order to view the

NOTE When choosing Rad/VPD Sum the screen will be split in two. To view the day sequence, press the Down arrow on the bottom part of the screen.

- Start time (hh:mm) - ENTER up to 6 start times (periods) per day for each program.
- Clock Start - Set the number of time-based irrigation cycles that will be performed in this cycle. The first cycle starts at the specified start time; subsequent cycles will start after the specified Min. Time.
- Cond. Starts (appears only when Cond. Is selected): On/Off.
 - On: Irrigations can be triggered by the Condition program, when the specified Condition program settings are met (Condition program active).
 - Off: Irrigations will not be triggered by the condition program, regardless of the Condition program status.
- Rad/VPD Sum Li.: Specify the radiation/VPD sum limit at which irrigation will take place. The Rad/VPD Sum counter of the specific program is automatically reset when irrigation is performed. If Rad/VPD sum limit is '0' it is ignored.
- Min. Time
 - In Rad/VPD sum and condition modes determine the minimum time allowed between irrigations.

- Even if the Rad/VPD sum limit / condition limit has been reached irrigation will not be performed until that time has passed.
- In clock starts the minimum time is the delay between start of a cycle until the start of the next cycle. For example if Clock Start is set to 2, the set Run Time is 30 minutes and the Min. Time is 45 minutes. The second cycle will start 15 minutes after the end of the first cycle.
- Max. Time: The maximum time between two subsequent cycles. This value is used to limit the time between two cycles when using dynamic irrigation triggers such as Rad/VPD Sum or the Condition program. When the specified Max. Time from the beginning of the previous cycle has elapsed; irrigation will take place regardless of the Rad/VPD Sum level or the Condition program status.
- Valve # - The Green Field DC can operate valves in any required order. Set the valve number and press . The following window will appear:

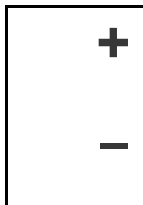

Select 'blank' and press  to set the valve to operate alone, or '+' (plus) to operate

together with the next valve. Several valves can be set to work together, as a group. A valve set (group) will have the same Run Time program and the same dosing program. Each irrigation program can include a maximum of 100 valves (columns) in any required order (all of them together, one after the other, a few groups-max. 100 groups, etc.). The same valve can be entered several times with different settings.

- Run Time #: attach a Run Time Program to a valve or a group of valves. When setting valves to work individually, a Run Time Program should be set for each valve. When setting a few valves to work together ("+" mark between them) a Run Time Program should only be set for the first valve, the rest of the valves will follow this setting.

NOTE *The quantity set in the Run Time Program will be the quantity given for all valves set to operate together, not per valve (for further specifications of the Run Time Program see WATER RUN TIME, page XX).*

- Dosing Program - Attach a Dosing Program to a valve or a group of valves. When setting valves to work individually, a Dosing Program should be set for each valve. When setting a few valves to work together (with "+" mark between them) a Dosing Program should only be set for the first valve, the rest of the valves will follow this setting.
- Day (xx/xx): Allows defining whether the program should irrigate water only, dose or be turned off on different days.
 - (xx/xx) - The right setting defines the day's cycle.
 - (xx/xx) - The left setting defines the current day of the cycle.

Select Dose, Water or None and press ENTER. 'Dose' means Fertigation (water + dosing), 'Water' means irrigation without dosing and 'None' means the program is idle in that day.

DATE : 1-May-12				TIME : 10:12:09			
IRRIGATION PROGRAM							
Program: 1	Priority: --			Const. 50%			
Start Time	07:00	12:00	16:00				
Clock Start	2	1	1				
Min. Time	01:00	00:30	--:--				
Valve #	051+05	004+116	115	255			
Run Time #	1 1	2 2	2	--2			
Dosing Prog	1 1	3 3	4	4			
Day: 04/06	1	2	3	4	5	6	
Dose / Water	D	W	-	D	W	D	

Dose

Water

None

The figure above shows "Day: 04/06", meaning the number of the days in the cycle is 6, and the current day is day 4. Day 1 and 5 are set to dose, day 3 is set to irrigate water only, and on days 2, 4 and 6 the program is idle.

9.1.1 SETTING IRRIGATION THAT IS LONGER THAN 24H

If a cycle day is 1 and the irrigation length is over 24 hours, the irrigation will repeat itself continuously, which means continuous irrigation.

NOTE Dosing operates according to ('D-W') for the same day and not according to the setting when the irrigation has started. If an irrigation starts at 18:00 and on this day dosing is set ('D'), the irrigation crosses midnight to a day where no dosing is set ('W'), dosing stops at midnight!

9.2 Water Run Time

The WATER RUN TIME table has 60 "floating" programs; each program can be configured so that irrigation water is given in time (HH:MM:SS) or in quantity (m3 or gallon, depending on definitions in the SYSTEM SETUP, page XX). The programs can later be connected to a valve or a group of valves through the Irrigation Program. Each program includes water, water before and water after settings.

- Method: Select the method (QTY. Or Time) with the up/down arrow keys and press ENTER to confirm.
- Water: Set quantity / time for each program (liter or gallon). The water setting is the total quantity / time including the Before and After settings.
- Before: Set quantity/time without dosing at the beginning of each irrigation cycle.
- After: Set quantity/time without dosing at the end of each irrigation cycle.

NOTE Before and After settings are deducted from the Water settings. Therefore Water quantity/time must be larger or equal to the Before and After settings.

9.3 Dosing

DOSING PROGRAM				
Program: 1				
INJECTION PER DOSING CHANNEL				
1	2	3	4	
EC	EC	ACID	PASSIV	—
3.00	5.00	6.00	5.00	—
Target EC		2.00		
Target PH		6.00		
Passive Dosing Method		QTY		
EC Dosing Method		P.QTY		
PH Dosing Method		P.QTY		

Screen 2 of 3 - In order to view the

Green Field DC includes 10 predefined dosing programs. Each program consists of injection methods, quantities and EC/pH target values.

Each channel is completely independent and can be set to give a different amount. Overlapping between the various channels is possible.

9.3.1 DOSING PROGRAM

- Program: Select a program by entering the program number, and confirm by pressing ENTER.
 - EC Pre-Control:
 - On: EC Pre-Control is active for this Dosing program.
 - Off: EC Pre-Control is not active for this Dosing program; the EC Pre-Control valve will be shifted towards the fresh water source.

INJECTION PER DOSING CHANNEL

- Dosing channel number: 1 to 8.
- Reaction: A read only line indicating the purpose of the channel;
 - EC: the channel is used to increase measured EC, meaning it will be opened more when the measured EC is lower than the set EC.
 - pH: the channel is used to decrease measured pH, meaning it will be opened more when the measured pH is higher than the set pH.
 - Passive: the channel does not respond to changes in measured EC/pH, meaning it will be opened as set in the Dosing program regardless of the EC/pH values.
 - Alkali: the channel is used to increase measured pH, meaning it will be opened more when the measured pH is lower than the set pH.
- Quantity / Time: Set the Quantity / Time to be injected for each dosing channel. The injection method (proportional, quantity, time, etc.) can be set separately for each use of the channel (EC, pH, Passive).
- Target EC: Set the required EC target value, only visible if EC control or EC alarms are active, see table 1.3.
- Target pH: Set the required pH target value, only visible if pH control or pH alarms are active, see table 1.3.

- Target EC Pre-Control: Set the required EC Pre-Control target value (only visible if EC-Pre Control is set to On, see EC-Pre Control above).
- Passive Dosing Method: Set the required injection method of the Passive dosing channels (see Dosing injection method).
- EC Dosing Method: Set the required injection method of the EC dosing channels (see Dosing injection method).
- pH Dosing Method: Set the required injection method of the Acid and Alkali dosing channels (see Dosing injection method).

Dosing Injection Method

- P.Qty (1/1000) - Proportional quantity. Each dosing channel can be set to give a different amount. The set amount is 1 part (Liter or Gallon) fertilizer/Acid per 1000 parts (m³/h or 1000 Gallons) of water.

For example:

- Channel 1 is set to 5.0 (liters or gallons).
 - Set water quantity is 3.5 (m³/h or 1000 gallons).
 - This setting actually means that 5.0 (liters or gallons) of fertilizer will be mixed with each cubic meter (1000 gallons respectively) of water passing through the system.
 - The total quantity of fertilizer that will be given is $5.0 * 3.5 = 17.5$ liters (Gallons).
- P.Time (hh:mm) - Proportional time. Each dosing channel is given the time to fertilize independently. The Green Field DC divides this time equally within the given irrigation time (quantity) set in 1.2 WATER RUN TIME.

For example:

Dosing channel -1- is set to 00:10, dosing channel -2- is set to 01:00.

Set irrigation time is 03:00 hours.

The Green Field DC will proportionally divide the set fertigation time for each dosing channel across the set irrigation time (quantity).

Dosing channel -1- will be on for a few pulses; their total time will be 10 min.

Dosing channel -2- will be on for a few pulses (not necessarily the same amount). Their total time will be 60 min.

- Time. (hh:mm) - Each dosing channel is given the time to fertigate. Dosing will be done in one bulk that will start after water, before time/quantity has elapsed.
- Qty. (Liters or Gallons) - Quantity. Each dosing channel is given the amount to be injected. Dosing will be done in one bulk or spread throughout the irrigation, depending on settings in the screen 7.7 DOSING CONFIGURATION, line Dosing by QTY. Method. Dosing will start after water, before time/quantity has elapsed.

To choose a method, place the cursor on the METHOD column and press ENTER. A small window will appear:

DOSING PROGRAM				
Program: 1				
INJECTION PER DOSING CHANNEL				
1	2	3	4	---
EC	EC	ACID	PASSIV	---
3.00	5.00	6.00	5.00	---
Target EC			2.00	
Target PH			6.00	
Passive Dosing Me		P. QTY	QTY	
EC Dosing Method		P. TIME	P.QTY	
PH Dosing Method		QTY.	P.QTY	

Select the method with the arrow keys and press  to confirm.

NOTE The EC/pH columns will not be visible if EC/pH control and EC/pH alarms are marked 'No'.

9.4 EXT. Condition

The Condition program allows starting and/or stopping irrigation according to dry contacts.

In addition, it is possible to define an output called Cond. This output will be active whenever the condition program settings are met. This enables using the condition program to start any external device.

- From (hh:mm): Set the start time of the condition program.
- To (hh:mm): Set the end time of the condition program

The condition program will only be operational in the defined time window (between start "From" to end "To" times). Each condition program can be operational on different hours.

- Start Dry Con.: Set the dry contact number for starting the irrigation.
- Trigger Type: Choose one of three trigger types:
 - One Shot: If the Start Dry Contact is closed for more than 20 seconds the associated irrigation program will be started. The contact must open and close to initiate irrigation.
 - Multi shot: If the Start Dry Contact is closed for more than 20 seconds the associated irrigation program will be started. If the contact is still closed when the irrigation has finished, irrigation will be initiated.

NOTE Notice that the Start Dry Contact does not necessarily have to open and close in order to initiate irrigation. It simply has to be closed when the irrigation has finished.

- Only If On - The associated Irrigation program will be turned on, providing the Start Dry Contact has been closed for more than 20 second and will remain on as long as the contact is closed.
- Stop Dry Con.: Set the dry contact number for stopping the irrigation. Since the Stop Dry Contact is "stronger" than the Start Dry Contact, the associated irrigation program will not be started as long as the Stop Dry Contact is closed.

*On the following page is a description graph of the Condition program:

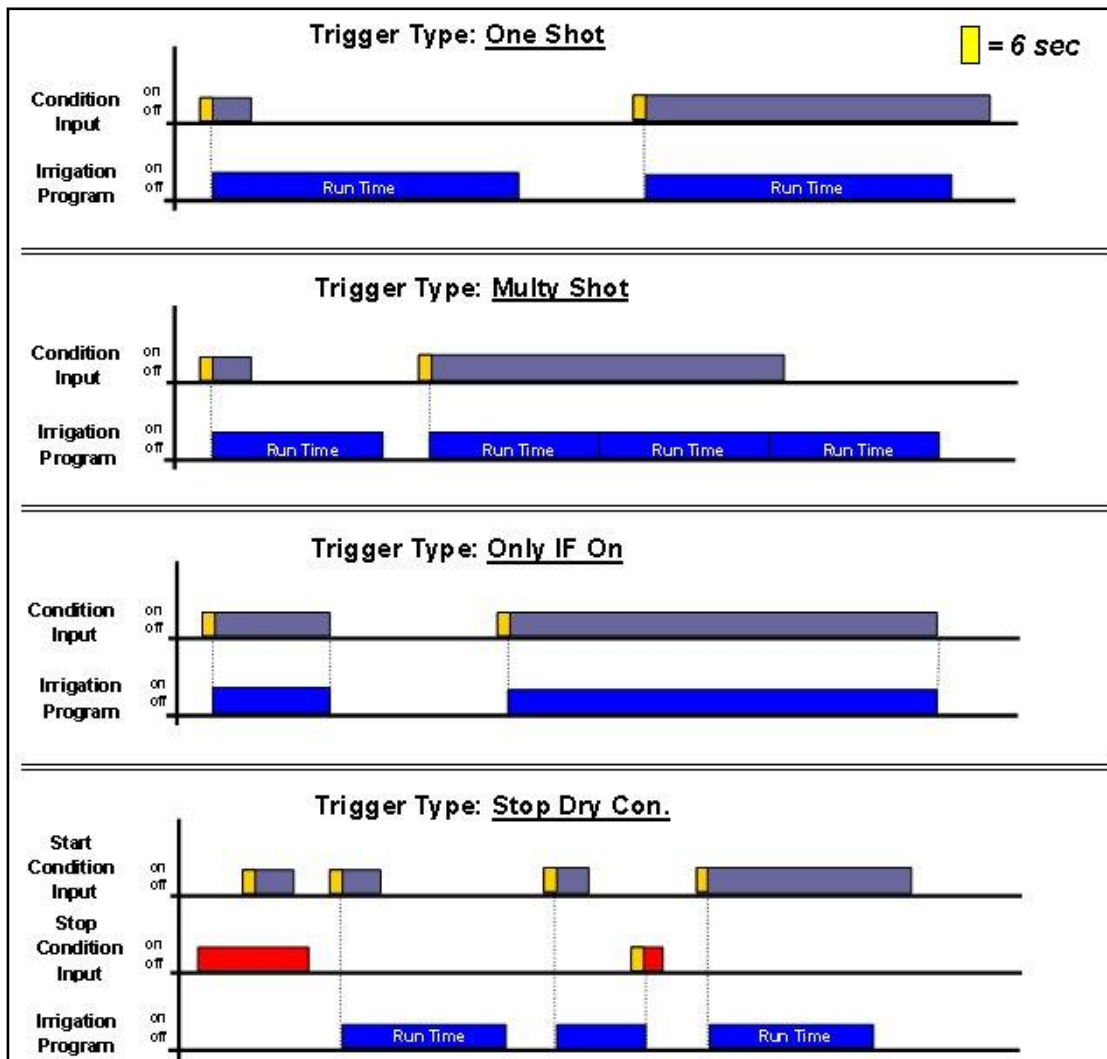

9.5 Agitator

The agitator is used to mix the fertilizers and acid in the storage tanks in order to prevent the occurrence of sediment.

- Dosing Active: Definition of the On and Off times of the agitator when dosing is taking place:
 - On: Define the required mixing time.
 - Off: Define the required time between mixing.
- Dosing Not Active - definition of the On and Off times of the agitator when dosing is not taking place:
 - On: Define the required mixing time.
 - Off: Define the required time between mixing.

9.6 Selector

Enables the use of various fertilizer stock tanks. Every dosing program can be connected to one (or more) selectors. Using the selector outputs you can choose which fertilizer stock will be connected to each dosing program.

Use the '+/-' keys to assign a selector to a dosing program.

9.7 Filter Flushing

Configuring the required process for filter flushing is allowed.

Notice that there are a few steps that should be defined prior to this screen:

- Stop Irrigation During Filter Flushing - Yes/No
- Stop Dosing During Filter Flushing - Yes/No
- Time Between Flushing (hh:mm) - Time interval between two consecutive Flushing cycles. The time is only counted during irrigation.
 - Example: If the time between flushing is set to 01:00 it means that a flushing cycle will be activated after 1 hour of irrigation (regardless of DP status).
 - If set to zero (--:--), flushing will only take place if triggered by a DP.
- Flushing Time (mm:ss): Flushing time of each Filter (output).
- Delay Between Filters (mm:ss) - The delay time between flushing of one filter to the next. This time is usually used to allow pressure buildup.
- Delta Pressure (Digital): Define whether filter flushing can be triggered due to digital Delta Pressure (Yes / No).
- Delta Pressure Value (bar): Define the Delta Pressure of the inlet pressure sensor (Pin) and outlet pressure sensor (Pout), at which filter flushing will be triggered (Only relevant when the application consists of analog Pin and Pout sensors).
- Delay Delta Pressure (mm:ss): Define the time that the Delta Pressure (digital or value) must be active before a filter flushing cycle will be triggered. This time is usually used to prevent unnecessary flushes from taking place.
- Delta Pressure Reiteration: Number of consecutive filter flushing cycles triggered by the Delta Pressure that can take place without any breaks, before the Green Field DC will generate an alarm indicating that the Delta pressure sensor is defective. The Green Field DC will then ignore the Delta Pressure and will continue flushing according to the set Time Between Flushing only, until the alarm is reset.
- Dwell Time Main Filter Valve (mm:ss): Define for how much time the main filter valve must be on before the filter flushing cycle is started. This output is typically used to control a pressure-sustaining valve or to start a booster pump.

9.8 Cooling

The Cooling/Humidification program is used to keep the temperature below a set value and/or the humidity above a set value. Each program can be set to maintain temperature or humidity as its first priority.

Five Cooling programs are available with two periods in each program. The periods can be defined to overlap, thus creating "dynamic" cooling or humidification.

Different temperature and humidity sensors can be connected to each program.

The Status can be defined as Cooling or Humidification, the aim of the status field is to help the user to understand the process that should take place by placing the related set point first (i.e. above t° when the status is cooling OR below RH when the status is Humidification)

NOTE There are a few steps that should be defined prior to this screen: see **COOLING CONFIGURATION**.

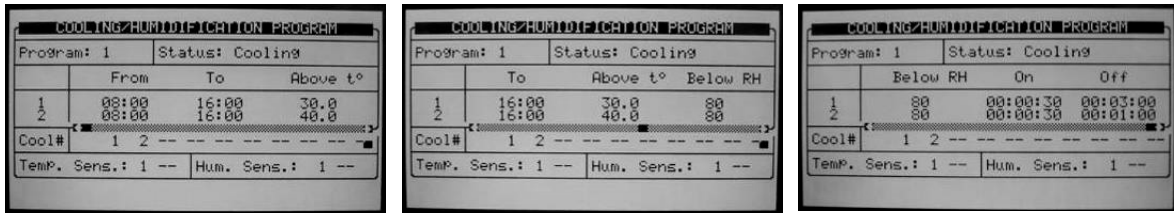

- Program: Choose the required program 1 to 8, press ENTER to confirm.
- Status: define whether the program's first priority is maintaining temperature or humidity.
- Cooling: the program's priority is temperature. If the two periods are overlapping and there are different settings in each period, dynamic cooling will take place.

Example:

- Settings:
 - Period 1 is set between 08:00 to 16:00, The cooling process should work above temp. of 30oC and Below RH of 80%.
 - Period 2 is set between 08:00 to 16:00, The cooling process should work above temp. of 40oC and Below RH of 80%
 - On time is fixed to 30 sec in both periods.
 - Off time is 3:00 minutes which relates to the lowest temperature setting (30°C)
 - Off time is 1:00 minute which relates to the highest temperature setting (40°C)

Scenarios:

- Time is 10:00, the measured temperature is 35oC and the measured relative humidity is 65%, the cooling valve will be open for 30 seconds and close for 2:00 minutes in a continuous cycle.
- Time is 12:00, the measured temperature is 30oC and the measured relative humidity is 65%, the cooling valve will be open for 30 seconds and close for 3:00 minutes in a continuous cycle.
- Time is 14:00, the measured temperature is 40oC and the measured relative humidity is 50%, the cooling valve will be open for 30 seconds and close for 1:00 minutes in a continuous cycle.
- Time is 15:00, the measured temperature is 35oC and the measured relative humidity is 85%, the cooling valve will not be open since the measured relative humidity is above the maximum allowed (80%).

NOTE If more than one cooling valve is defined, the off time will take place after the last valve in the sequence (Cooling valve #2, in the above screen). Between the cooling valves there is no delay and they are working in sequence, from the first valve on the left side to the last one.

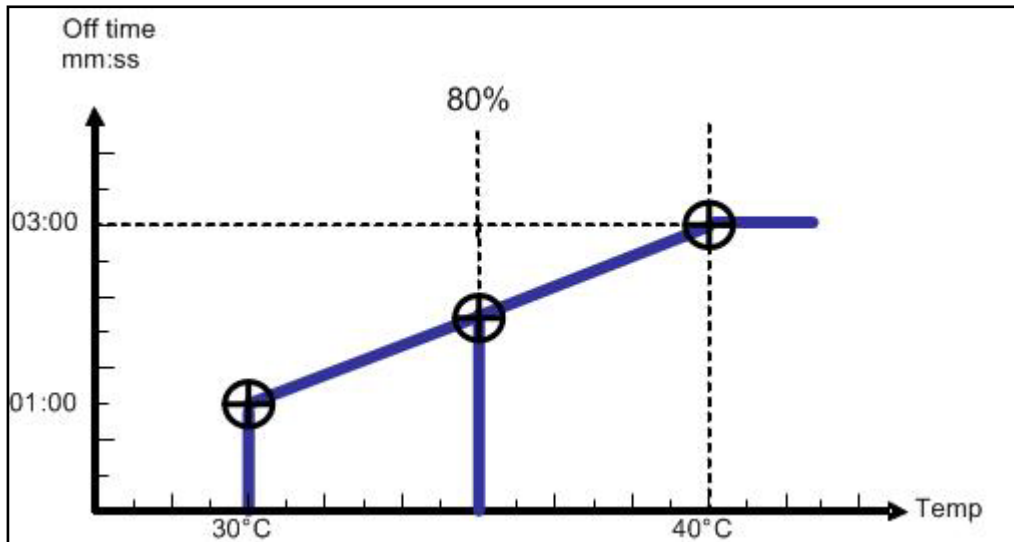

NOTE If the time is relevant only for a certain period, only its settings will define operation. If humidity is above the lowest value of the two periods, cooling will not take place.

- From (hh:mm): Set the start time of the Cooling / Humidification program.
- To (hh:mm): Set the end time of the Cooling / Humidification program

NOTE The program will only be operational in the defined time window (between start "From" to end "To" times). Each program can be operational on different hours.

- Above to / Below RH:
 - Above to (when status is cooling) - Start cooling above this temperature. Cooling will stop if the temperature drops below the internal dead-band of 0.5oC. For example if set to 30oC cooling will start when the temperature is above 30oC and will stop when it drops below 29.5oC.
 - Below RH (when status is humidification) - Start humidification below this humidity. Humidification will stop if the humidity goes above the internal dead-band of 1%. For example, if set to 80% humidification will start when the humidity is below 80% and will stop when it is above 81%.
- Below RH / Above to:
 - Below RH (when status is cooling) - Stop cooling above this humidity. Cooling will be resumed when the humidity drops below the internal dead-band of 2%. For example, if set to 80% cooling will stop when the humidity is above 82% and will be resumed when the humidity drops below 80%.
 - Above to (when status is humidification): Stop humidification when the temperature is below this temperature. Humidification will be resumed when the temperature goes above the internal dead-band of 0.5oC. For example, if set to 25oC humidification will stop when the temperature drops below 24.5oC and will be resumed when it goes above 25oC.
- On (hh:mm:ss): Define the On time of the Cooling valve. If On time is set to zero the Cooling valve will not be opened.
- Off (hh:mm:ss): Define the Off time of the Cooling valve. If Off time is set to zero the Cooling valve will be constantly On.
- Cool # - Assign cooling valves to this program. The assigned cooling valves will be operated sequentially in groups. The number of groups (different cooling

programs) which can be operated simultaneously (maximum cooling parallel) is defined in screen 6.2 SYSTEM SETUP.

- Temp. Sens.: Assign Up to two temperature sensors for this program.
- Hum. Sens.: Assign up to two humidity sensor to this program.

If there is a malfunction in one of the temperature sensors, a message will be displayed, and that sensor will be taken out of the average temperature calculation. If all the temperature sensors are out of order, the controller will operate according to the first active line.

If you would like to operate the program by time only, set as follows:

Set Status to cooling or humidification (not important). Set the Above t°. and Below RH to '0'. Define the required On and Off times and the program will work accordingly within the set time frame.

9.9 Misting

The misting program is a time scheduler used to open/close a misting valve or any other device that is operated sequentially. Up to 40 misting programs can be preset.

Note that there are a few steps that should be defined prior to this screen, see the MISTING CONFIGURATION Table on page 93.

MISTING PROGRAM					
#	No.	Start hh:mm	End hh:mm	On hh:mm:ss	Off hh:mm:ss
1	1	08:00	18:00	00:00:30	00:10:00
2	2	10:00	19:00	00:00:50	00:13:00
3	3	11:00	18:00	00:01:00	00:16:00
4	4	08:00	13:00	00:00:55	00:20:00
5	5	09:00	20:00	00:00:18	00:30:00
6	6	10:00	00:00	00:01:02	00:15:00
7	7	--:--	--:--	--:--:--	--:--:--
8	8	--:--	--:--	--:--:--	--:--:--
9	9	--:--	--:--	--:--:--	--:--:--
10	10	--:--	--:--	--:--:--	--:--:--

- Mist No.: Assign a mist valve to the program. It is possible to associate the same misting valve to several programs.
- Start (hh:mm): Set the start time of the Misting program. If start time is set to 00:00, it will automatically be changed to --:--, meaning the program is not operational.
- End (hh:mm): Set the end time of the Misting program. The Misting program will only be operational in the defined time window (between Start to End times). Each Misting program can be operational on different hours.
- On: Define the On time of the misting valve. If On time is set to zero the MISTING valve will not be opened.
- Off: Define the Off time of the MISTING valve. If Off time is set to zero the MISTING valve will be constantly On.

The table is sorted according to mist number as the first priority, and start time as the second priority. The Mist No. will always appear in groups in an increasing order so that the orientation is quick and easy.

Each mist group has an inside start time sorting, so that a later start is moved to the end of the group. If you delete a row (by zeroing the Mist .No.) it will be moved to the end of the table and the rest of the rows will move one step up. Pressing the menu key does this sorting.

NOTE When misting is on all related devices (e.g. misting valve, main valve and pump) are operational. When misting is off, only the pump continues to operate.

9.10 Water Heating

Water Heating operates according to temperature within a set time frame (between start "From Time" to end "To Time") and can be used to increase irrigation water temperature or prevent frost.

- From Time (hh:mm): Set the start time of the water-heating program.
- To Time (hh:mm): Set the end time of the water-heating program.
- Water Temperature - Water heating will be activated when the temperature drops below this value.
- Difference: Dead-band for stopping water heating. When the water temperature reaches the set Water Temperature + Difference, water heating will be stopped.
For Example: Water temperature is 25°C and the difference is 2°C. Water heating will start when the temperature drops below 25°C and will stop when it is 27°C or above.
The Minimum difference is 0.3°C and the default is 0.5°C.
- Temp. Sensor 1/2: Assign up to 2 temperature sensors. If you assign 2 sensors, the Green Field DC will operate according to their average.

10 Manual Operation



- Irrigation Pause
- Start/Stop Program
- Start/Stop Valve
- Filter Flushing

10.1 Irrigation Pause

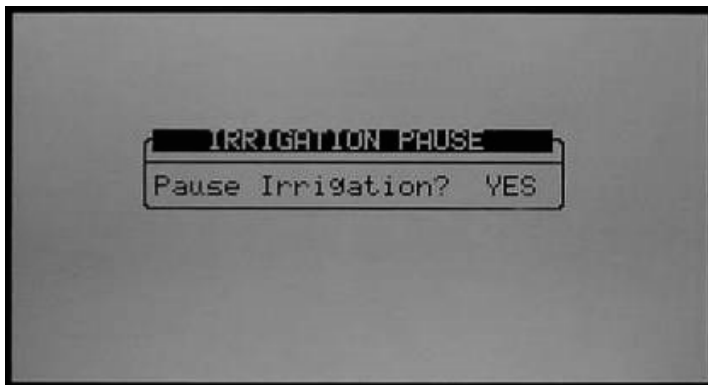

- Pause irrigation (Yes/No): Set Yes and press Enter to confirm; all irrigations will be paused until the value will be set back to No. When the system is released from Pause mode it will complete all irrigations that should have taken place when it was paused.

10.2 Start/Stop Program

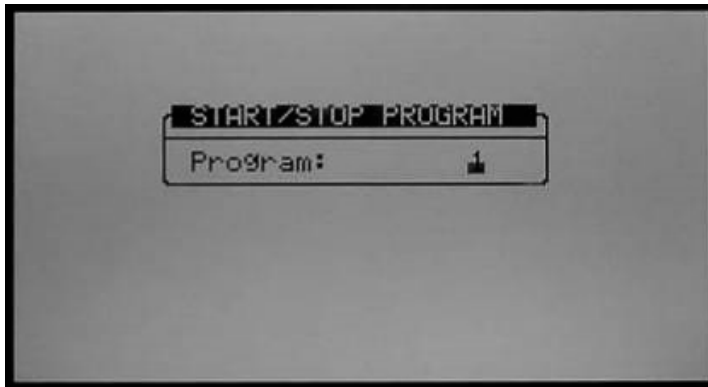

1. Enter a program number to start and press

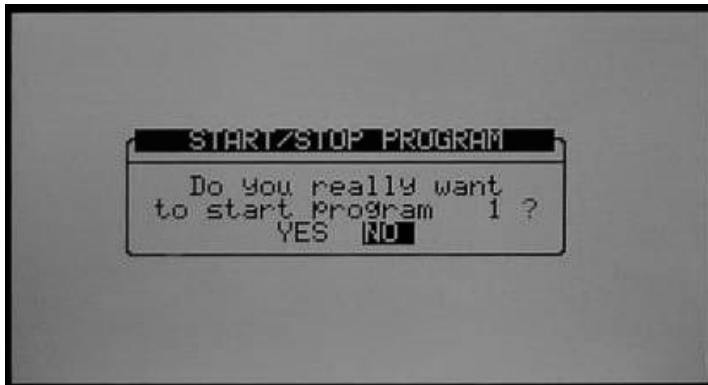

2. Select 'Yes' to confirm your choice and start the relevant program.
3. When you enter the Start/Stop screen during irrigation you will be asked whether you wish to stop the active program. Choose Yes to stop the program.

10.3 Start/Stop Valve

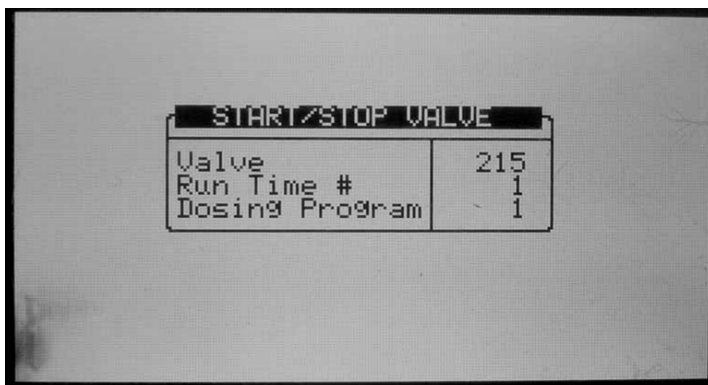

1. Enter a valve number, Run Time program and (optional) dosing program, press



to confirm and then press the menu button to open the confirmation screen.



2. Select 'Yes' if you wish to start the relevant valve.
3. When you enter the Start/Stop screen and a valve is active you will be asked whether you wish to stop the relevant valve. Choose Yes to stop the valve.

10.4 Filter Flushing

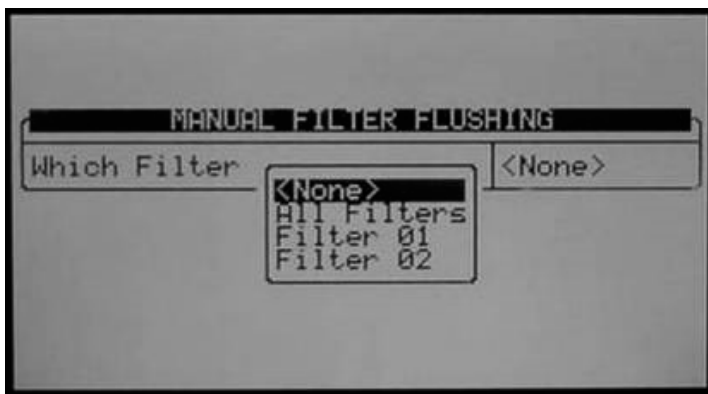

To flush filters manually, follow the prompts, select which filters to flush with the arrow

keys and press  to confirm.

You can flush all filters or individual filters (without Pump or Main valve operation)

11 Alarm

The alarm menu allows configuration of alarms, alarm actions and reset active alarms. It also provides history of previous alarms.

The alarm menu is divided into EC/pH related alarms and none EC/pH related alarms.



- Alarm Reset
- History
- Alarm Definition
- Alarm Setting
- EC/pH Alarm Definition
- EC/pH Alarm Setting
- Radio SYS. Alarm Definition
- Radio Sys. Alarm View
- SMS Subscription

11.1 Alarm Reset

This table shows active alarms and failures. The upper section allows you to cancel failures and reset alarms.

Period of Automatic Reset allows you to set a time in which the Green Field DC will try to reset the alarms automatically and complete the uncompleted processes.



11.2 History

Every alarm from the last reset will have a record in this table (Up to 250 alarms).

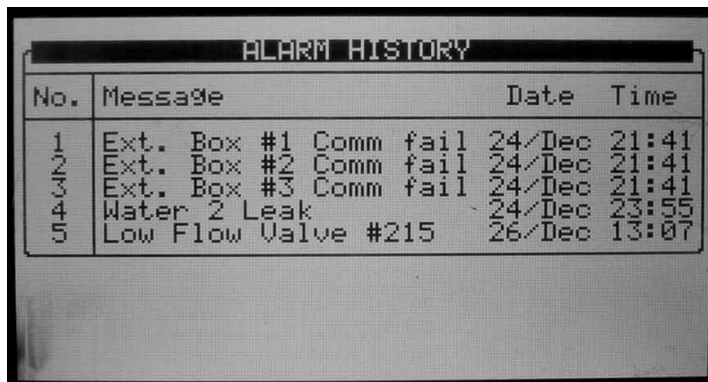

11.3 Alarm Definition

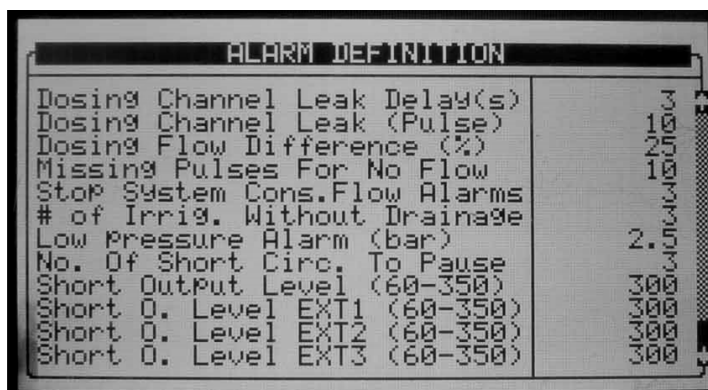
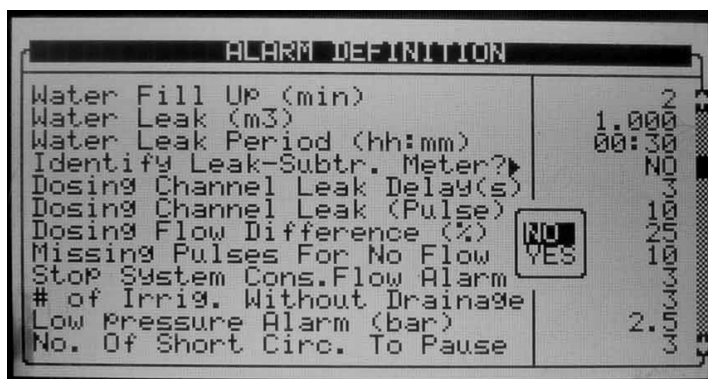

- Water Fill Up (min) - Time for line fill up. The system will ignore high flow and will not generate a High Flow alarm during this period.
- Water Leak (m³ or Gal) - Quantity of water to trigger a water leak alarm. The quantity is either in m³ or gallon depending on the choice of volume units.
- Water Leak Period (hh:mm) - Time frame to measure the water-leak quantity. If it takes the system more time than indicated here to measure the water-leak quantity, the system will not generate an alarm.
- Identify Leak-Subtr. Meter?: Choose whether to identify (Yes / No) when a water leak occurs in a subtracting water meter (relevant only when operating by water source).
- Dosing Channel Leak Delay (s): Delay after dosing channel is stopped before the system starts measuring dosing channel Leak. This feature is usually used to cope with problems regarding hydraulic pumps that work with dosing meters.
- Dosing Channel Leak (Pulse) - Number of pulses generated by the dosing meter during which the dosing channel should be idle before the system will generate a dosing leak alarm.
- Dosing Flow Difference (%): Difference between calculated and measured dosing channel flow above or below which an alarm will be generated. For example, if the calculated dosing channel flow is 100 l/h, and the actual flow is less than 70 l/h or above 130 l/h an alarm will be generated (depending on this parameter's value. This example refers to a parameter set to 30).
- Missing Pulses For No Flow: Number of missing pulses before the system will generate a No Flow alarm. The system calculates the expected time between pulses according to the calculated flow rate and the volume per pulse of the water meter, if more time has passed than expected for the set number of missing pulses the system will generate a No flow alarm.
- Stop System Consecutive Flow Alarms: Number of consecutive flow alarms of the same type (high flow, low flow etc') but different valves before the system is stopped. This setting is used to pause the system when there is a general malfunction that occurs in a few valves (or valve groups). The number on the right side of the table indicates the number of consecutive flow alarms. Reaching set point activates a Stop System Consecutive flow alarm.

CAUTION *Warning: When the water meter does not generate pulses and “missing pulses for NO FLOW” or “Max consecutive flow alarms” are in ignore mode, irrigations by quantity will be “stuck” until stopped manually.*

- # of Irrigations Without Drainage: Number of irrigations given without measuring drainage, above which an alarm will be generated. This alarm usually indicates that the irrigation quantity is too small or that there is a malfunction in the drainage measurement.
- Low Pressure Alarm (bar/psi): Define the minimum allowed pressure, under which an alarm will be generated.
- Num. Of Short Circ. To Pause: Number of short circuit alarms measured before the system is paused. This setting is used to pause the system when a general malfunction occurs causing several outputs to short circuit.
- Short Output Level (60-350): Define the A/D threshold value to be considered as a short circuit (for further instructions see Green Field DC: Part 2 > Appendix 1: General > Short Circuit Control).¹

The following parameters will be visible only if an Extension box is defined;

- Short O. Level EXT1 (60: 350) - Define the A/D threshold value to be considered as a short circuit for Extension box no. 1 (for further instructions see Green Field DC: Part 2 > Troubleshooting > Short Circuit Control).¹
- Short O. Level EXT2 (60: 350) - Define the A/D threshold value to be considered as a short circuit for Extension box no. 2 (for further instructions see Green Field DC: Part 2 > Troubleshooting > Short Circuit Control).¹
- Short O. Level EXT3 (60: 350) - Define the A/D threshold value to be considered as a short circuit for Extension box no. 3 (for further instructions see Green Field DC: Part 2 > Troubleshooting > Short Circuit Control).¹

*NOTE*¹ This value is set according to the table 5.1 parameter 'Load output level' parameter.

11.4 Alarm Setting

ALARM SETTING				
Description	Irri.	Dose	Delay mm:ss	Alarm Active
High Flow	STOP	STOP	01:00	YES
Low Flow	STOP	STOP	01:00	YES
No Flow	STOP	STOP	----	YES
D. Ch. Leak	STOP	STOP	30:00	YES
D. Ch. Fault	STOP	STOP	01:00	YES
Ext. Pause	PAUSE	IRRIG.	00:30	YES
D. Boos.Prot.	CONT.	STOP	01:00	YES
Low Pressure	STOP	STOP	01:00	YES
R.U. Error	STOP	STOP	01:00	YES
Host Error	STOP	STOP	01:00	YES

The Alarm Setting table allows you to define the required response for failures recognized by the Green Field DC:

- STOP: Stop irrigation and/or dosing for current valve (or valve group) and continue to the next valve (or valve group).
- CONT: Continue irrigation and/or dosing for the valve (or valve group) that caused the alarm. This option actually means that the system will generate an alarm but will not take action.
- Delay (mm:ss): Define the period the failure must be active before the Green Field DC will generate an alarm and will take action.
- Alarm Active: Define whether the alarm output should be triggered by the appropriate alarm.

NOTE An alarm will be generated on the Green Field DC screen even if the unit has been set to continue (ignore) or the alarm output has been set as not active (or not defined at all).

NOTE The Green Field DC will not reset a "R.U. Error" alarm once the error has been corrected in the remote unit; the alarm will only be reset upon Period of automatic reset or when reset manually by the user (Reset now function).

11.5 EC/pH Alarm Definition

EC/pH ALARM DEFINITION	
Delta EC Low	0.0
Delta EC High	0.0
Delta pH Low	0.0
Delta pH High	0.0
Delta EC-Pre Control Low	0.0
Delta EC-Pre Control High	0.0
Emergency EC High(1 Min.Dly)	4.0
Emergency pH Low (1 Min.Dly)	4.0

- Delta EC Low: If the measured EC value is lower than the target value minus Delta EC Low, the system will generate a Low EC Alarm.
- Delta EC High: If the measured EC value is higher than the target value plus Delta EC High, the system will generate a High EC Alarm.
- Delta pH Low: If the measured pH value is lower than the target value minus Delta pH Low, the system will generate a Low pH Alarm.
- Delta pH High: If the measured pH value is higher than the target value plus Delta pH High, the system will generate a High pH Alarm.
- Delta EC Pre-Control Low: If the measured EC Pre-Control value is lower than the target value minus Delta EC Pre-Control Low, the system will generate a Low EC Pre-Control Alarm.
- Delta EC Pre-Control High: If the measured EC Pre-Control value is higher than the target value plus Delta EC Pre-Control High, the system will generate a High EC Pre-Control Alarm.
- Emergency EC High (1 minute delay): If the measured EC is higher than the value set here for more than 1 minute, the system will be stopped. This setting should be used to protect the plants/system and should generally be higher than the EC High Alarm based on the dosing-program target value plus the Delta EC High.
- Emergency pH Low (1 minute delay): If the measured pH is lower than the value set here for more than 1 minute, the system will be stopped. This setting should be used to protect the plants/system and should generally be lower than the pH Low Alarm based on the dosing-program target value minus the Delta pH Low.

11.6 EC/pH Alarm Setting

EC/pH ALARM SETTING				
Description	Irri.	Dose	Delay mm:ss	Alarm Active
EC High/Fail	STOP	STOP	01:00	YES
EC Low	STOP	STOP	01:00	YES
pH High	STOP	STOP	01:00	YES
pH Low/Fail	STOP	STOP	01:00	YES
EC-P.Hi/Fail	STOP	STOP	01:00	YES
EC-Pre. Low	STOP	STOP	01:00	YES
E.Tank Fresh	STOP	STOP	01:00	YES
E.Tank Drain	STOP	STOP	01:00	YES
EC Sen. Dif.	STOP	STOP	01:00	YES
pH Sen. Dif.	STOP	STOP	01:00	YES

The EC/pH alarm setting table allows you to define the desired response for EC/pH related failures recognized by the Green Field DC:

- STOP: Stop irrigation and/or dosing for current valve (or valve group) and continue to the next valve (or valve group).
- CONT: Continue irrigation and/or dosing for the valve (or valve group) that caused the alarm. This option actually means that the system will generate an alarm but will not take action.
- Delay (mm:ss): Define the period the failure must be active before the Green Field DC will generate an alarm and will take action.
- Alarm Active: Define whether the alarm output should be triggered by the appropriate alarm.

11.7 Radio SYS. Alarm Definition

RADIO SYS. ALARM DEFINITION			
Alarm Type	Delay mm:ss	Active	Inform
RTU			
Vbatt failure	00:00	YES	YES
Vbatt low	00:00	NO	YES
Vbatt warn	00:00	NO	YES
Cap failure	00:00	NO	YES
Card failure	00:00	NO	YES
I/O Open	00:00	NO	YES
I/O Shor	00:00	NO	YES
HOST			
Over current	00:00	NO	YES

NOTE IMPORTANT: For Radio System to work properly, MUST define in the 6.2 SYSTEM SETUP menu: Remote Unit type parameter SN/RF Net.

In this screen, define Radio Systems alarm activity and notification.

- ACTIVE: defines if alarm is used in making decisions regarding irrigation program (YES / NO)
- INFORM: defines if the system will notify the user of the alarm occurrence (YES / NO)

11.8 Radio Sys. Alarm View

RADIO SYS. Alarm view				
Unit	S/N	Comm	Vin state	Card
HOST	0128	OK	-	-
BASE	0117	FAIL	-	-
RTU	0236	OK	-	3.1
RTU	0115.3.4	-	OK	-
RTU	0513.4.1	-	FAIL	-
RTU	0198	-	WARN	-
RTU	0555.3.1	-	LOW	-
RTU	----	-	-	-
RTU	----	-	-	-
RTU	----	-	-	-

In this screen, view the current alarm status of the Radio System.

The S/N column is the number of the unit. When an Open Circuit or Short Circuit alarm is detected, the system in addition will also present the card number and the input/output number that is problematic.

For Example: RTU: 0555.3.1

- Unit: 555
- Card: 3
- Input/Output: 1

Exiting and re-entering refreshes the alarm status screen.

11.9 SMS Subscription

N/A

12 History

The history menu provides extensive information regarding measurements and processes performed by the Green Field DC.

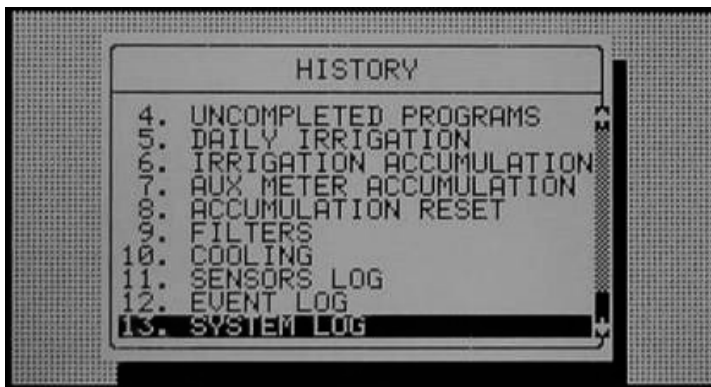
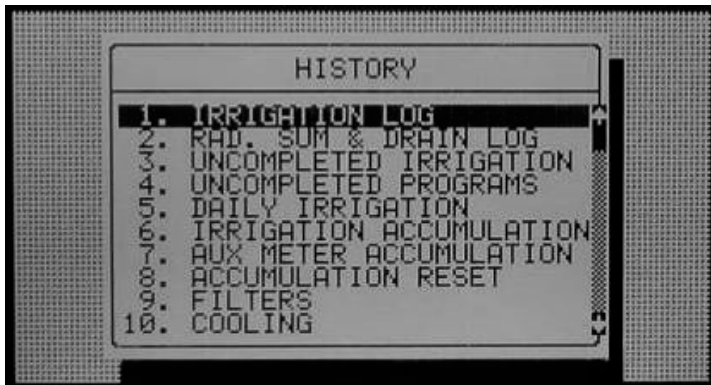

- Irrigation Log
- RAD. / VPD Sum & Drain Log
- Uncompleted Irrigation
- Uncompleted Programs
- Daily Irrigation
- Irrigation Accumulation
- AUX Meter Accumulation
- Accumulation Reset
- Filters
- Cooling
- Sensors Log
- Event Log
- System Log

12.1 Irrigation Log

- The Irrigation Log table includes up to 200 rows of the last irrigations data.
- Each row includes information regarding a specific irrigation.
- To view additional information, use the left/right arrow keys.
- To switch between dosing quantities or time simply press the '+/-' key.

Date	Time	UI	Reason	Water
23/Dec	17:21	255	Rad Sum	3.671
23/Dec	17:32	254	Rad Sum	0.834
23/Dec	17:42	217	Rad Sum	4.884
23/Dec	17:52	115	Rad Sum	2.584
23/Dec	18:02	219	Rad Sum	0.834
24/Dec	14:50	255	Rad Sum	3.671
24/Dec	15:00	254	Rad Sum	0.834
24/Dec	15:10	217	Rad Sum	4.887
24/Dec	15:20	115	Rad Sum	2.583
24/Dec	15:30	219	Rad Sum	0.834

Date	Time	UI	Duration	Flow
23/Dec	17:21	255	00:10:00	22.000
23/Dec	17:32	254	00:10:00	5.000
23/Dec	17:42	217	00:10:00	24.000
23/Dec	17:52	115	00:10:00	15.000
23/Dec	18:02	219	00:10:00	5.000
24/Dec	14:50	255	00:10:00	22.000
24/Dec	15:00	254	00:10:00	5.000
24/Dec	15:10	217	00:10:02	24.000
24/Dec	15:20	115	00:10:00	15.000
24/Dec	15:30	219	00:10:00	5.000

Date	Time	UI	Chan. 1	Chan. 2
23/Dec	17:21	255	0.000	6.000
23/Dec	17:32	254	0.000	0.834
23/Dec	17:42	217	4.444	1.444
23/Dec	17:52	115	0.000	1.444
23/Dec	18:02	219	0.000	0.834
24/Dec	14:50	255	0.000	6.000
24/Dec	15:00	254	0.000	0.834
24/Dec	15:10	217	4.444	1.444
24/Dec	15:20	115	0.000	1.444
24/Dec	15:30	219	0.000	0.834

- Date: Date in which the irrigation started.
- Time: Time in which the irrigation started.
- Valve: Leading valve; the first valve set for the group of valves
- Reason: Specification of the irrigation triggers; time, condition, Rad Sum, etc.
- Water: Irrigation quantity (m3 or gallon) or irrigation time.
- Duration: Irrigation duration (hh:mm:ss).
- Flow: Average flow throughout the irrigation cycle.
- Chan. #: Dosing quantities per channel (liter or gallon) or dosing time.
- EC Low: Lowest EC value recorded during irrigation.
- EC Avg.: Average EC value recorded during irrigation.
- EC High: Highest EC value recorded during irrigation.
- pH Low: Lowest pH value recorded during irrigation.
- pH Avg.: Average pH value recorded during irrigation.
- pH High: Highest pH value recorded during irrigation.

NOTE Water quantity is measured in m3 or gallons, duration is measured by time, flow is measured in m3/h or gallon/m, dosing quantity is measured in liters or gallons.

12.2 RAD. / VPD Sum & Drain Log

Date	Time	UI	Reason	Water
20/Dec	17:26	254	Rad Sum	1.400
20/Dec	17:26	217	Rad Sum	1.400
20/Dec	17:27	115	Rad Sum	1.400
20/Dec	17:27	219	Rad Sum	1.400
20/Dec	17:27	255	Rad Sum	1.400
20/Dec	17:28	254	Rad Sum	0.800
20/Dec	17:28	217	Rad Sum	0.800
20/Dec	17:28	115	Rad Sum	0.800
20/Dec	17:28	219	Rad Sum	0.800
20/Dec	17:29	255	Rad Sum	0.800

Date	Time	UI	Drain %	Drain
20/Dec	17:26	254	100.00	1450
20/Dec	17:26	217	92.85	1300
20/Dec	17:27	115	78.57	1100
20/Dec	17:27	219	100.00	1400
20/Dec	17:27	255	-----	0
20/Dec	17:28	254	62.50	500
20/Dec	17:28	217	100.00	800
20/Dec	17:28	115	18.75	150
20/Dec	17:28	219	-----	0
20/Dec	17:29	255	100.00	850

Date	Time	UI	Rad Sum	Interval
20/Dec	17:26	254	10	----
20/Dec	17:26	217	10	----
20/Dec	17:27	115	10	1
20/Dec	17:27	219	10	1
20/Dec	17:27	255	10	2
20/Dec	17:28	254	10	----
20/Dec	17:28	217	10	----
20/Dec	17:28	115	10	----
20/Dec	17:28	219	10	1
20/Dec	17:29	255	10	1

- Time: Time irrigation started.
- Valve: Leading valve.
- Reason: Specification of the irrigation triggers; time, condition, rad sum, etc.
- Water: Irrigation quantity (m3 or gallon) or irrigation time.
- Drain %: Percentage of drain for relevant irrigation cycle.

- Drain: Drain quantity related to relevant irrigation.
- Rad Sum: Accumulated radiation sum level when irrigation started.
- VPD Sum: Accumulated VPD sum level when irrigation started.
- Interval: Time (in minutes) since last irrigation cycle. Refers to the last irrigation of a specific valve.

12.3 Uncompleted Irrigation

The Uncompleted Irrigation table provides information of irrigations that were started but could not be completed due to a failure. To understand why an irrigation was not completed it is advisable to cross-reference between this table and the Alarm HISTORY table, page 47. The Uncompleted Irrigation table consists of up to 200 lines. Note that if the letter 'C' appears, it refers to a program that was triggered by condition program.

UNCOMPLETED IRRIGATION						
No.	Date	Time hh:mm	Prog No.	Vl. No.	Run No.	Dose Prog
1	20-Dec-06	09:05	1	51+	1	1
2	20-Dec-06	09:25	2	1	1	--

Each line includes information regarding when the irrigation was stopped and added to the uncompleted irrigations table.

- Date: Date in which the current line was added to the uncompleted irrigation table.
- Time: Time in which the current line was added to the uncompleted irrigation table.
- Prog. No.: Program number.
 - 92: The program that was added to the table was started manually.
 - 93: The relevant irrigation was added to the uncompleted irrigations table for the second time (or more) consecutively.
- Vl. No. - Indicates the associated valve. If a group of valves that is configured to irrigate together is stopped, only the first valve is written but a '+' sign is added next to it to indicate that more valves are associated.
- The Green Field DC will attempt to complete the irrigations from the current day (until end day time) upon manual or automatic alarm reset.
 - The valve column of irrigations that are to be completed will be highlighted.
 - The valve column of irrigations that are currently being completed will blink.
- Run No.: Indicates the associated run time program.
- Dose Prog.: Indicates the associated dosing program.
- Prog. Qty.: Planned quantity according to the run time program.
- Left Qty.: Uncompleted quantity.

In order to manually stop an uncompleted irrigation you must go to the START/STOP VALVE table, page 45 because the activation is according to single valves.

12.4 Uncompleted Programs

The Uncompleted Programs table provides information on programs that could not be completed. It is important to understand the difference between this table and the Uncompleted Irrigations table; this table consists only of irrigation cycles that haven't been started and could not be completed during the current day. This can happen due to wrong system setup (more tasks than could be completed), or because the system was not active for a long period of time, for example due to a power failure, and could not complete its tasks.



No.	Date	Time hh:mm	Prog No.	Start Time	Prog Cyc.	Left Cyc.
4	9/Aug	20:00	10	19:00	1	1
5	9/Aug	21:00	10	20:00	1	1
6	10/Aug	04:00	1	13:00	2	2
7	10/Aug	05:00	1	04:00	2	2
8	10/Aug	06:00	10	21:00	1	1
9	10/Aug	07:00	1	05:00	2	2
10	10/Aug	09:00	1	07:00	2	2
11	10/Aug	11:00	1	09:00	2	2
12	10/Aug	13:00	1	11:00	2	2
13	10/Aug	14:00	10	06:00	1	1

The uncompleted program table consists of 200 lines.

12.5 Daily Irrigation

This table allows you to view history of irrigation quantities or time per valve.

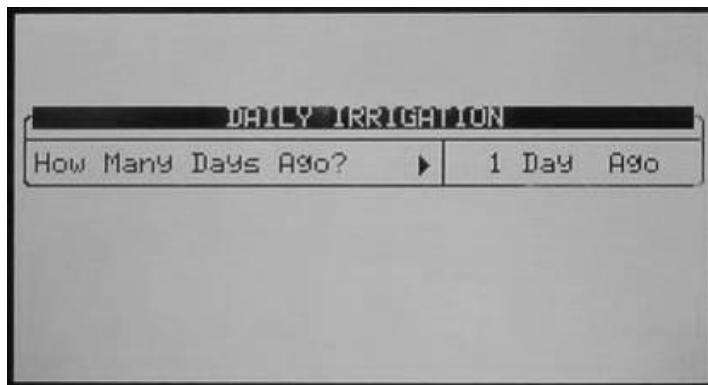

Press ENTER to open the selection list, move with the arrow keys to the relevant day and confirm your choice by pressing ENTER.

For example, 1 day ago means you would like to view yesterday's history, and Today means you would like to view the accumulated history since the last End Day.

The relevant date you are currently viewing will be displayed at the top of the screen.

The Daily Irrigation table contains all water (m³ or gallon) and dosing (liter or gallon). To toggle the view between quantities and time, press the '+/-' key.

12.6 Irrigation Accumulation

The Irrigation Accumulation table allows you to accumulate water and dosing quantities for the required periods. The accumulation of each valve can be reset separately in the ACCUMULATION RESET table.

Valve	Date	Water	Chan. 1
214	20-Dec-06	0.000	0.00
215	20-Dec-06	70.800	211.36
216	20-Dec-06	1.400	3.93
217	20-Dec-06	19.100	35.28
218	20-Dec-06	7.200	19.06
219	20-Dec-06	16.800	29.65
220	20-Dec-06	0.000	0.00
221	20-Dec-06	0.000	0.00
222	20-Dec-06	0.000	0.00

Valve	Chan. 1	Chan. 2	Chan. 3
214	0.00	0.00	0.00
215	211.36	211.37	211.37
216	3.93	3.94	3.94
217	35.28	35.21	35.21
218	19.06	19.97	19.12
219	29.65	30.38	29.86
220	0.00	0.00	0.00
221	0.00	0.00	0.00
222	0.00	0.00	0.00

To toggle the view between quantities and time, press the '+/-' key.

Water quantity is measured in cubic meter or gallons; dosing quantity is measured in liters or gallons.

12.7 AUX Meter Accumulation

The Auxiliary Meter Accumulation table allows you to accumulate quantities from meters that do not have designated software, for example, in order to measure the drain water quantity or to measure the cooling system's consumption.

NOTE These water meters are accumulators only and are not a part of the irrigation control.

Meter	Quantity	Date
1	4.600	20-Dec-06
2	3.500	20-Dec-06
3	2.200	20-Dec-06
4	2.500	20-Dec-06
5	3.450	20-Dec-06
6	3.600	20-Dec-06
7	5.700	20-Dec-06
8	4.200	20-Dec-06

The quantities displayed are in liters (gallons) up to 9999.999.

To reset an auxiliary meter refer to the ACCUMULATION RESET table below.

12.8 Accumulation Reset

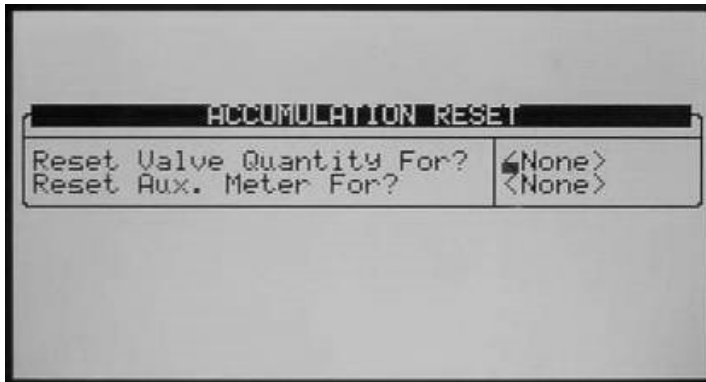

To reset accumulation of an individual valve or of all valves press the ENTER key, choose the relevant option using the arrow keys and confirm by pressing the ENTER key.

When resetting a valve (or all valves) its history will be erased from the following tables:

- Daily Irrigation
- Irrigation Accumulation

To reset an individual auxiliary meter or all auxiliary meters press the ENTER key, choose the relevant option using the arrow keys, and confirm by pressing ENTER.

CAUTION When resetting an Aux meter (or all Aux meters) its history will be erased from the Aux Meter Accumulation table.

12.9 Filters

The filters history table provides daily information of the number and cause of flushing.

The screenshot shows a terminal window with the title "FILTERS". Below the title is a table with four columns: "Date", "Delta P.", "Time", and "Manual". The table contains three rows of data.

Date	Delta P.	Time	Manual
10/Aug	0	44	0
9/Aug	0	0	0
8/Aug	0	0	0

12.10 Cooling

Viewing the history of cooling activities or time per valve is allowed.

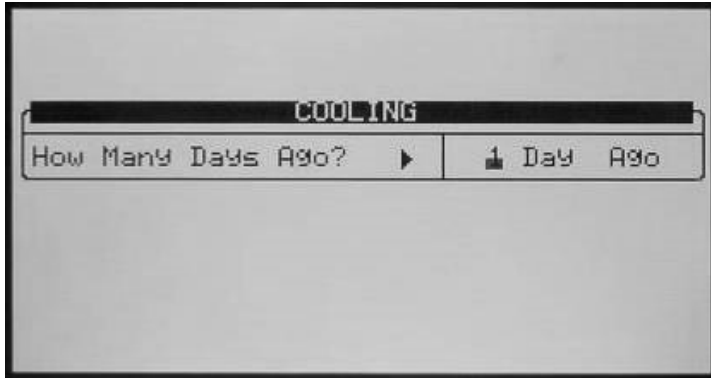

Press ENTER to open the selection list, move with the arrow keys to the relevant day and confirm your selection by pressing ENTER.

For example, 1 day ago means you would like to view yesterday's history, and Today means you would like to view the accumulated history since the last End Day.

12.11 Sensors Log

The sensors Log table includes history of average measurements of logged sensors. To define which sensors should be logged and the averaging interval refer to table 6.2.

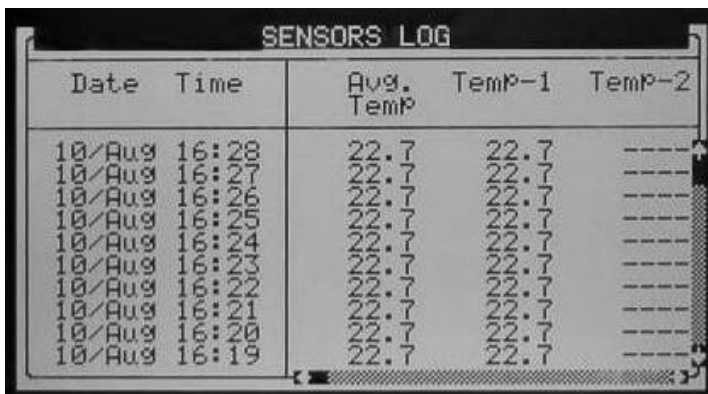
A screenshot of a terminal window titled "SENSORS LOG" displaying a table of sensor data. The table has four columns: "Date Time", "Avg. Temp", "Temp-1", and "Temp-2". The data rows show a sequence of measurements from 10/Aug 16:19 to 10/Aug 16:28, with "Avg. Temp" and "Temp-1" values of 22.7 and "Temp-2" values represented by dashes. A vertical scrollbar is visible on the right side of the table.

Date Time	Avg. Temp	Temp-1	Temp-2
10/Aug 16:28	22.7	22.7	----
10/Aug 16:27	22.7	22.7	----
10/Aug 16:26	22.7	22.7	----
10/Aug 16:25	22.7	22.7	----
10/Aug 16:24	22.7	22.7	----
10/Aug 16:23	22.7	22.7	----
10/Aug 16:22	22.7	22.7	----
10/Aug 16:21	22.7	22.7	----
10/Aug 16:20	22.7	22.7	----
10/Aug 16:19	22.7	22.7	----

The sensors Log table contains up to 10,000 data fields. Date and time are 2 fields per line and every sensor is an additional field.

For example: logging of 2 sensors uses 4 data fields; 2 for time and date and 1 for each sensor. In this case, the table will consist of a maximum of 2,500 lines.

12.12 Event Log

The table provides information of all the processes performed by the Green Field DC including their time and date.

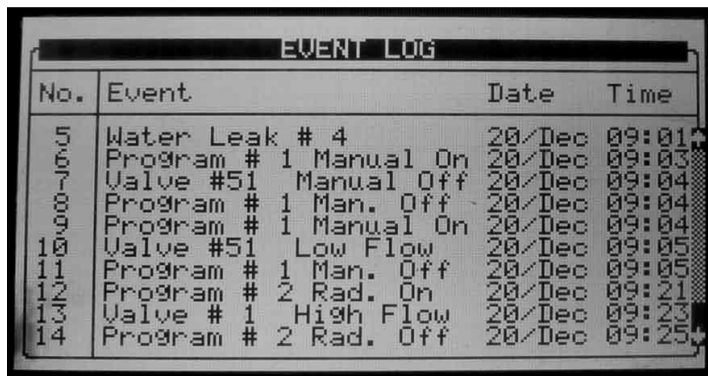

No.	Event	Date	Time
5	Water Leak # 4	20/Dec	09:01
6	Program # 1 Manual On	20/Dec	09:03
7	Valve #51 Manual Off	20/Dec	09:04
8	Program # 1 Man. Off	20/Dec	09:04
9	Program # 1 Manual On	20/Dec	09:04
10	Valve #51 Low Flow	20/Dec	09:05
11	Program # 1 Man. Off	20/Dec	09:05
12	Program # 2 Rad. On	20/Dec	09:21
13	Valve # 1 High Flow	20/Dec	09:23
14	Program # 2 Rad. Off	20/Dec	09:25

The table consists of the last 999 events.

12.13 System Log

This table provides information of all the system changes. Examples of system changes are changes of triggered by the controller, the PC communication, a power off, etc.

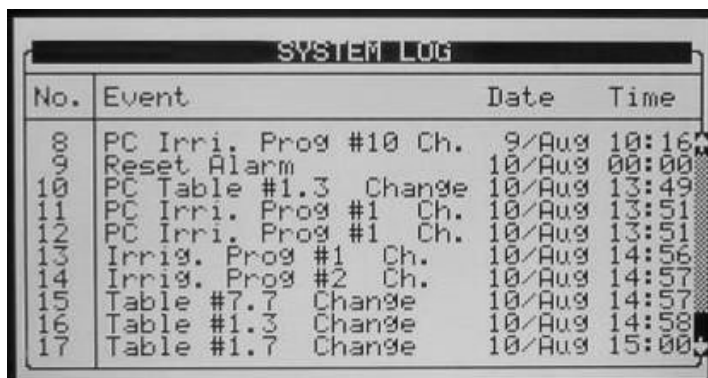

No.	Event	Date	Time
8	PC Irri. Prog #10 Ch.	9/Aug	10:16
9	Reset Alarm	10/Aug	00:00
10	PC Table #1.3 Change	10/Aug	13:49
11	PC Irri. Prog #1 Ch.	10/Aug	13:51
12	PC Irri. Prog #1 Ch.	10/Aug	13:51
13	Irrig. Prog #1 Ch.	10/Aug	14:56
14	Irrig. Prog #2 Ch.	10/Aug	14:57
15	Table #7.7 Change	10/Aug	14:57
16	Table #1.3 Change	10/Aug	14:58
17	Table #1.7 Change	10/Aug	15:00

The table consists of the last 999 events.

13 Test



The Test menu provides a quick way of verifying functionality.

- Relays
- Digital Input
- Analog Input
- Temperature
- Humidity
- Hardware Check List

13.1 Relays

The Relays Test screen allows you to check the current output status and verify proper operation.

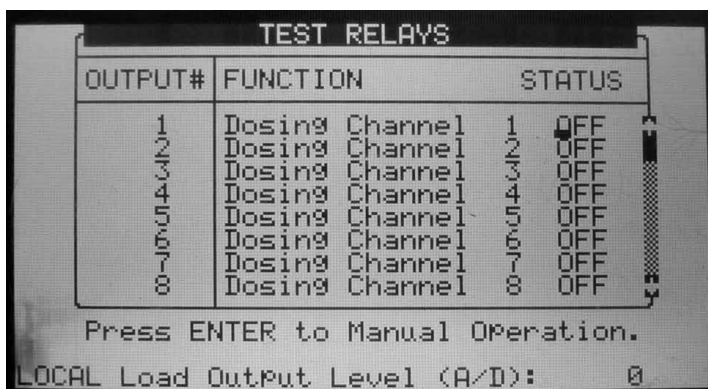

TEST RELAYS			
OUTPUT#	FUNCTION		STATUS
126	None	0	OFF
127	Same As Relay	11	OFF
128	Valve	54	OFF
129	Valve	115	OFF
130	Valve	116	OFF
131	Valve	117	OFF
132	None	0	OFF
133	None	0	OFF

Press ENTER to Manual Operation.

EXT1 Load Output Level (A/D): 0

TEST RELAYS			
OUTPUT#	FUNCTION		STATUS
249	None	0	OFF
250	None	0	OFF
251	None	0	OFF
252	None	0	OFF
253	None	0	OFF
254	None	0	OFF
255	Same As Relay	13	OFF
256	Valve	255	OFF

Press ENTER to Manual Operation.

EXT3 Load Output Level (A/D): 0

The setting switches automatically between ON and Off depending on device actual status.

To manually test relay functionality, move the cursor to required device using the arrow keys and press ENTER; the device will be turned On and the setting will show Man.

Press ENTER again to return to automatic operation.

- OFF: The output is not active.
- ON: The output is automatically turned on by the relevant program.
- Man: Manual operation of the output. The manual operation resets after 30 minutes of being idle, to prevent you from forgetting to set it back to automatic operation.
- Load Output Level: Output level in A/D values. The value is constantly updated in accordance to relay operation and output level change. This value is used to calculate the A/D threshold value to be considered as a short circuit.

13.2 Digital Input

The Digital Input test screen allows you to verify the proper operation of digital inputs and sensors.

Digital inputs are defined as meters (water meters, dosing meters, etc) that count the number of closed contacts from 0 to 255 and automatically restart back from 0.

Other digital inputs (Dry contact, Ext. Pause, etc) show either 0 when the contact is open or 1 when the contact is closed.

Note that the card number is set according to its jumpers regardless to its location (local or extension box).

DIGITAL INPUT				
Channel	Card No.1	Card No.2	Card No.3	Card No.4
1	59	28	37	39
2	00	00	00	00
3	00	00	00	00
4	00	00	00	00
5	00	00	00	00
6	00	00	00	00
7	00	00	00	00
8	00	00	00	00
9	00	00	00	00
10	00	00	00	00
11	00	00	00	00

13.3 Analog Input

Analog inputs will show values from 0 to 1023.

ANALOG INPUT		
Channel	Card No.1	Card No.2
1	439	791
2	216	846
3	231	859
4	552	1022
5	240	1005
6	405	1010
7	328	1011
8	359	1013
9	383	318
10	5	248
11	1001	786

Sensor type	Description
pH sensor	pH = 0: A/D = 205
	pH = 7.0: A/D = 615
	pH = 14.0: A/D = 1023
EC sensor	EC = 0: A/D = 205
	EC = 2.0: A/D = 370
	EC = 10.0: A/D = 1024
Humidity sensor	RH% = 0: A/D = 0
	RH% = 50: A/D = 308
	RH% = 100: A/D = 620
Temp sensor	T°C = 0: A/D = 768
	T°C = 25: A/D = 489
	T°C = 50: A/D = 250

13.4 Temperature

This table shows the current temperature sensor readings in degrees (Celsius or Fahrenheit depending on the setup in the SYSTEM SETUP screen).

TEMPERATURE	
No.	Value
1	22.8
---	---
---	---
---	---
---	---
---	---

13.5 Humidity

This table shows the current humidity sensor readings in % relative humidity.

HUMIDITY	
No.	Value
1	55.3
---	---
---	---
---	---
---	---
---	---

13.6 Hardware Check List

The Hardware Check List displays which and how many output and input cards are connected and where they are connected; local, or in one of the extension boxes. Position of cards connected locally will appear on the bottom table.

HARDWARE CHECKLIST				
DESCRIPTION	LOC.	EXT1	EXT2	EXT3
Analog Input	2	0	0	0
Digital Input	1	1	1	1
Relay Card	5	3	8	3
Ext. Box Version	-	1.01	1.01	1.01

COM.	Relay 64+57	---	A. In No.2	A. In No.1	D. In No.1
Relay 1+ 8	Relay 9+16	Relay 17+24	Relay 25+32	---	P.S.

To update the hardware checklist, disconnect the Green Field DC from the power supply or perform a cold start procedure.

The bottom row shows 24VAC output cards, dry contact output cards and power supply. The upper row shows dry contact output cards, analog and digital input cards, and communication card.

NOTE Notice that in the large boxes this table should be turned left to see actual cards position. For example the communication card (COM.) will actually be on the bottom left side of the box.

14 Setup

The SETUP menu provides clock, calibration; plug storage/retrieval and language settings.



- Time & Date
- System Setup
- Temperature Calibration
- Humidity Calibration
- EC/pH Calibration
- Pressure Calibration
- Weather Station Calibration
- Sensors Logging
- Write to Data Plug
- Read from Data Plug
- Edit SMS Phonebook
- SMS Setup
- SMS Personal Message

14.1 Time & Date

The Time & Date screen allows you to set the current time and date as well as the end of the crop daytime.

To adjust the time and date, place the cursor on the setting you wish to modify, change the numbers using the keypad and press ENTER to save your changes.

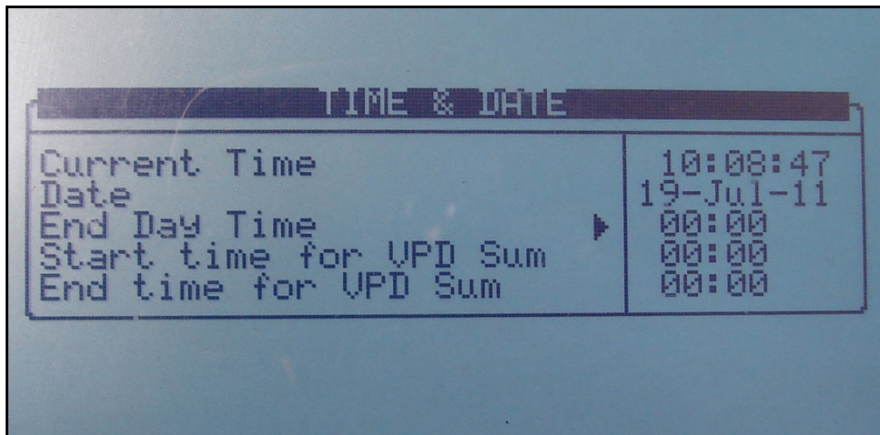

- End Day Time - Select the start time of a new day 00:00 to 23:00.

At End Day time:

- All the alarms are reset.
- All the uncompleted irrigations are reset. Irrigation cycles that haven't been completed will move to the UNCOMPLETED PROGRAMS table, page 57.
- All the valves that are registered in the uncompleted programs table and did not complete the irrigation are switched from Wait position to Do Not Continue (Move to history).
- Cycle days in the PROGRAM
- IRRIGATION table are moved one day ahead.
- The daily % change is zeroed (the constant % change stays the same).
- Currently active cycle will continue with its current settings until completed.
- Start/End time for VPD Sum: Set the time frame for the VPD Sum counter.
- Only during this time frame will the VPD be summed
- At End time for VPD Sum, the counter is reset

14.2 System Setup

The System Setup screen includes all general system settings.

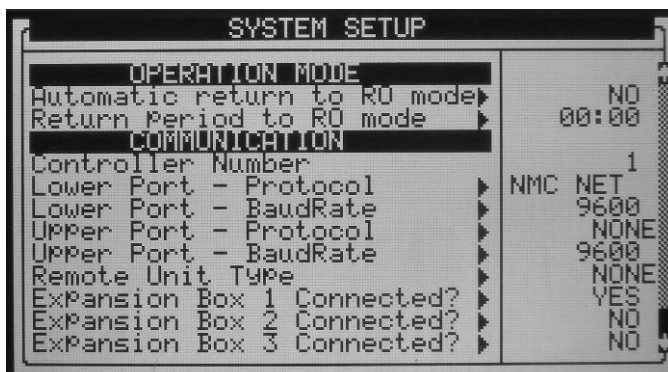
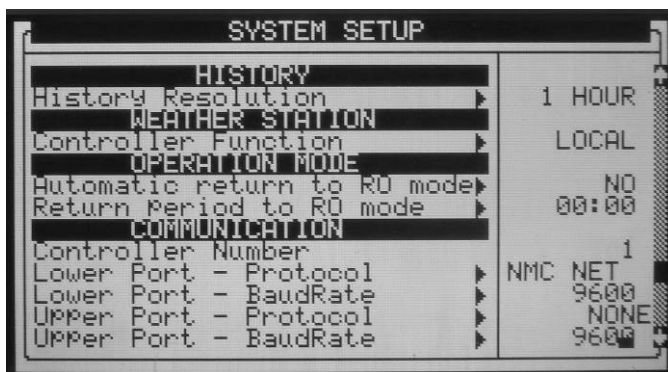
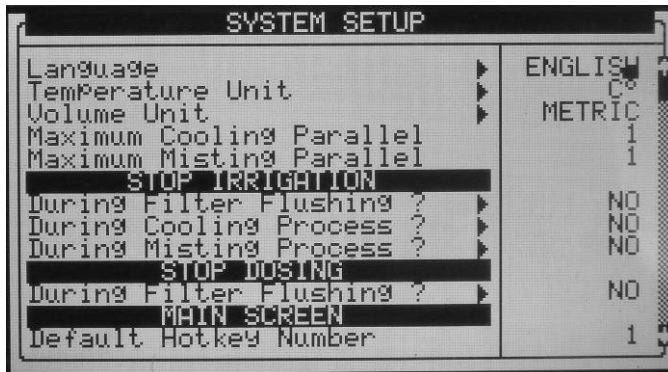

- Language: Choose controller language.
- Temperature Unit - Celsius or Fahrenheit.
- Volume Unit - Metric (m3 & Liter) or Gallon. These units also influence the pressure measurement units; when choosing metric pressure, measurement will be in bar, when choosing gallon pressure, measurement will be in PSI.
- Maximum Cooling Parallel: Define the maximum number of cooling programs to be operated simultaneously. The maximal possible number is 8.
- This number refers to the number of cooling programs that will be operated in parallel; valves from the same cooling program will always be operated sequentially.
- Maximum Misting Parallel: Define the maximum number of misting valves to be operated simultaneously. The maximal possible number is 40.

STOP IRRIGATION

- During Filter Flushing: Define whether irrigation should be stopped during filter flushing.
- During Cooling Process: Define whether irrigation should be stopped during cooling.
- During Misting Process: Define whether irrigation should be stopped during misting.

STOP DOSING

- During Filter Flushing: Define whether dosing should be stopped during filter flushing.

MAIN SCREEN

- Default Hotkey Number: Define the required default hotkey number. When the system is idle for a few minutes the controller will automatically switch to the default hotkey (hot-screen)

HISTORY

- History Resolution - Set the history collection rate of the sensors. For example if set to 15 minutes, the controller will collect data from the defined sensors every 15 minutes (see 6.8 SENSORS LOGGING for configuring which sensors / data is collected).

WEATHER STATION

- Controller function: Define whether this controller is connected to a weather station directly or through the network.
 - Local: A weather station is connected to this controller; its data is used locally only and should not be passed or received through the network.
 - Slave: This controller receives weather station data through the network; the data is collected by another Green Field DC (or NMC-64 Climate), which is connected directly to a weather station defined as Master. Sensors connected directly to a slave controller will be used by it and will have a higher priority than those transmitted by the master.
 - Master: A weather station is connected to this controller and its data should be transmitted through the network to other controllers. There can be only one master controller of any type in each network.

OPERATION MODE

- Automatic return to RO mode: Define if the controller will return automatically back to the Read Only mode after a certain period of time.
- Return Period to Read Only mode: Set the amount of time for the controller to return automatically to the Read Only mode (mm:ss).

This parameter is only relevant if the Automatic return to RO mode parameter is defined as YES

COMMUNICATION

- Controller Number - Select the controller number for communication. The controller number in the controller and in the PC should match in order for the

communication to work. Each controller in the network must have a unique number.

- Lower Port: Protocol: Communicate with:
 - Green Field Net - Local Network
 - GSM RCLP: GSM Modem
- Lower Port: BaudRate (PC Communication Network) - Select the lower port's baud rate for communication. The baud rate in the controller and in the PC must match; otherwise, the communication cannot operate properly.

NOTE See Green Field DC Part 2 > Appendix 4: Network connection & PC software for additional information regarding controller number and baud rate.

- Upper Port: Protocol: SN/RF Net. Square One Single Net protocol should be selected in order to define the Remote Unit Type.
- Upper Port: BaudRate (Extension Box Network) - Select the upper port's baud rate for communication. The baud rate in the controller and in the extension boxes must match; otherwise, the communication cannot operate properly.

NOTE Green Field DC Part 2 > Table 2: Baud rate values. This table provides explanations regarding how to set the Baud rates in the extension boxes.

- Remote unit type: Select the type of remote units connected to the Green Field DC:
 - NONE: No remote units are connected to the Green Field DC.
 - SN/RF Net- SingleNet or RadioNet remote units are connected to the Green Field DC.
 - SA RADIO: Radio remote units are connected to the Green Field DC.

NOTE When choosing SingleNet or RadioNet relevant parameters will appear in the controller.

NOTE Only one type on remote units (SingleNet or Radio) can be connected to a specific controller.

- Extension Box # Connected: Specify whether the relevant extension box is connected or not. The Green Field DC will "search" for the relevant extension box and will update the HARDWARE CHECK LIST and all other relevant settings accordingly. If the Green Field DC doesn't recognize the extension box an alarm "Ext. Box # Com fail" will be generated, in case communication is reestablished the alarm will be automatically reset.

WATER SOURCE

- Flow Rate: Start From: Select whether the flow rate calculation in an irrigation will begin either with the value Zero (which means that the flow rate will increase according to pulses received), or a Nominal value calculated using all the active valves in the irrigation. The calculation method is important primarily for dosing and EC/pH control. When using a controller which operates with relatively slow pulses, it is recommended to choose the Nominal flow rate option due to inaccurate flow calculation in the first stage of the irrigation. When operating with slow pulses and starting with a Zero value, it will take a long time for the controller to reach its' actual flow rate value. When operating by fast pulses, choose either Zero or Nominal.

- **Calculated Flow Delay:** This parameter is relevant only when Nominal is being selected in the previous parameter. This parameter defines the time the controller uses its' nominal flow rate value before switching to the calculated one. In this period LOW FLOW and HIGH FLOW alarms will not be detected.

14.3 Temperature Calibration

Enables calibrating temperature sensors. Use the Left/right arrow keys to increase/decrease the values.

It is recommended to calibrate the temperature sensors using a reference sensor.

14.4 Humidity Calibration

Enables calibrating humidity sensors. Use the Left/right arrow keys to increase/decrease the values.

It is recommended to calibrate the humidity sensors using a reference sensor.

14.5 EC/pH Calibration

Calibration of EC & PH is comprised of two steps:

- Calibration of the EC/pH Monitor Transmitter, page 80
- EC/pH Transmitter Monitor & Green Field ECO Correlation, page 83

14.5.1 CALIBRATION OF THE EC/PH MONITOR TRANSMITTER

Use the following instructions when using the EC/pH transmitters. When using other types of transmitters use calibration guidelines supplied by the manufacturer and jump to EC/pH Transmitter Monitor & Green Field ECO Correlation.

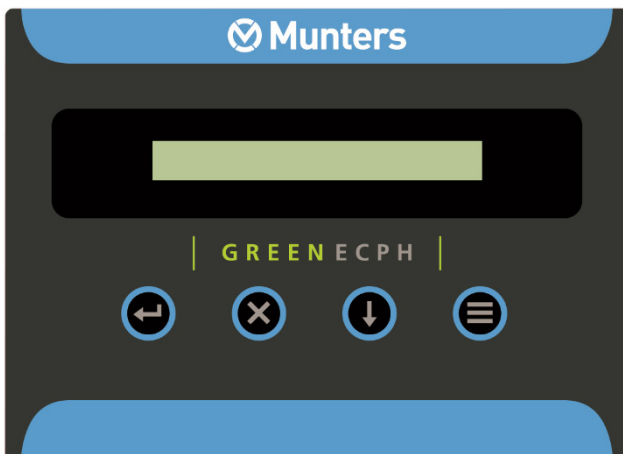

EC & PH main screen



14.5.1.1 EC Calibration

- Auto Set EC (EC factory set)
- EC Soft Calibration

14.5.1.1.1 Auto Set EC (EC factory set)







The Auto set procedure initializes all the previous corrections and sets the calibration according to the factory settings.

Perform Auto set on the first run and when you replace an EC Electrode with a new one.

1. Press the  button and wait for the Service prompt to appear.
2. Press  button several times until *AUTOSET EC* prompt is displayed and then press . The message OK is displayed for a while and then the display reverts back to normal.

NOTE Always perform EC Soft Calibration after the Auto set EC (EC factor set)

14.5.1.1.2 EC Soft Calibration

1. Press  and wait for the Service prompt to appear.
2. Press  several times until the *CALIB (rate) EC* prompt is displayed and press .
3. Use  to choose *EC 1.4* or *EC 5*, according to your water value and the buffers you have, press  to confirm.
4. Insert the probe into the appropriate buffer, wait for approximately 10 seconds, and press . You will be asked to wait for a few seconds, while the unit performs the value correction.
5. The Gain point is now set and *EC 0.0* will be displayed. Hold the EC probe out in the open air and wipe it gently with a napkin or a tissue, then press .

6. If the calibration process is completed successfully, *EC Calibration OK* is displayed. If it fails, *EC CALIBRATION FAIL* is displayed, in this case refer to Green Field ECO Irrigation: Part 2 > EC/pH > Troubleshooting.



14.5.1.2 pH Calibration

- Auto Set pH (pH Factory set)
- pH Soft Calibration

14.5.1.2.1 Auto Set pH (pH Factory set)

The Auto set procedure initializes all the previous corrections and sets the calibration according to the factory settings.





Perform Auto set on the first run and when you replace a pH electrode with a new one.

1. Press  and wait for the Service prompt to appear.
2. Press  several times until *AUTOSET pH* is displayed and press . The message OK is displayed for a while and then the display reverts back to normal.

NOTE Always perform *pH Soft Calibration* after the *Auto set pH (pH factory set)*

14.5.1.2.2 pH Soft Calibration

1. Remove the pH probe and clean it by directing a stream of water towards its membrane. Do not wipe or dry the membrane.

2. Press  and wait for the *Service* prompt to appear.
3. Press  several times until the *CALIB (rate) pH* prompt is displayed and then press .
4. When *pH 7.0* is displayed, immerse the probe in the pH 7.0 buffer, wait for approximately 10 seconds and press . You will be asked to wait for a few seconds, while the unit performs the value correction. The Gain point is now set.
5. When *pH 4.0* is displayed, immerse the probe in the pH 4.0 buffer, wait for approximately 30 seconds and press . You will be asked to wait for a few seconds, while the unit performs the value correction. The Offset point is now set.

6. If the calibration process is completed successfully, *pH Calibration OK* will be displayed. If it fails, *LOQUID IS POOR* is displayed, please refer to Green Field ECO Irrigation: Part 2 > EC/pH > Troubleshooting.

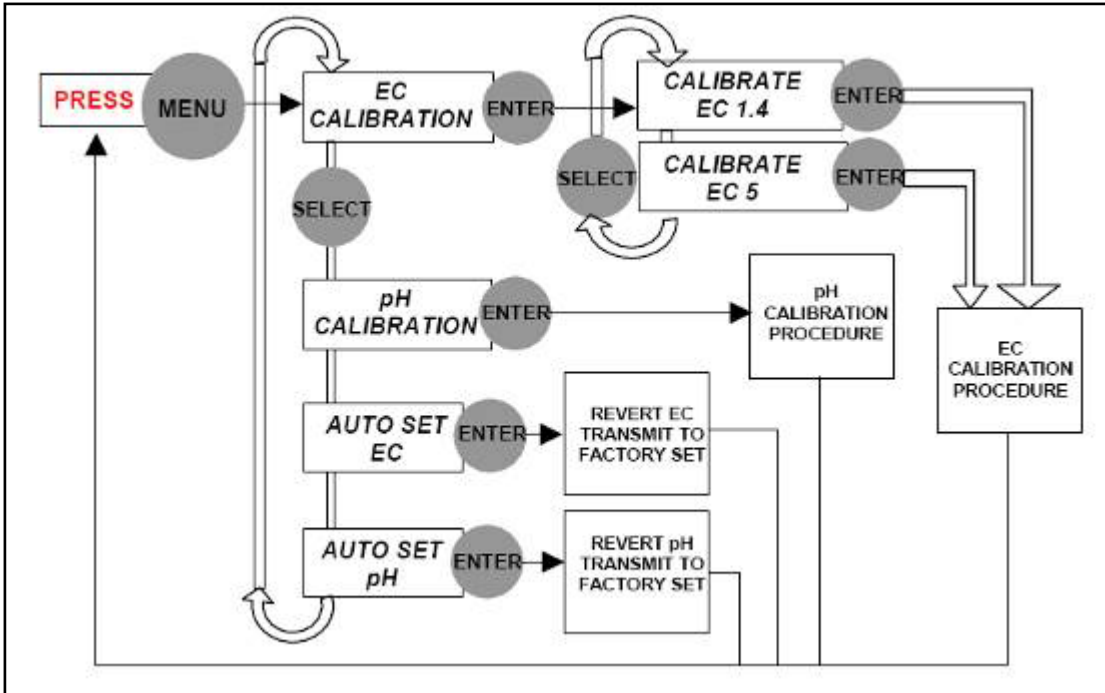

Menu Navigation Schema

14.5.2 EC/PH TRANSMITTER MONITOR & GREEN FIELD ECO CORRELATION

EC/pH CALIBRATION		
Sensor	Value	Factor
EC 1	1.71	0.06
pH 1	2.36	0.07
EC 2	<NONE>	---
pH 2	<NONE>	---

Press <-> Arrows to Increase/Decrease

Place the cursor on the relevant factor and use the left/right arrow keys to increase/decrease the factor until the values displayed by the Green Field ECO are equal to the values indicated on the EC/pH transmitter screen.

To ensure the measured values are stable it is recommended to immerse the sensor in calibration fluid when doing this process.

Under normal operation conditions the correlation process should be done only when there are system changes, for example when changing EC/pH sensors, nevertheless it is recommended to verify that the readings of the EC/pH transmitter and of the Green Field ECO are equal every time EC/pH calibration is performed, and adjust if required.

14.6 Pressure Calibration

Inlet and outlet pressure sensors calibration.

Calibration of the pressure sensors is usually done using reference pressure sensors connected in the vicinity of the electronic pressure sensors.

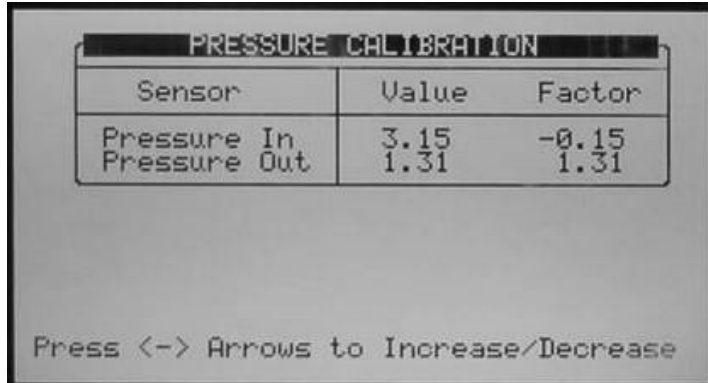

Sensor	Value	Factor
Pressure In	3.15	-0.15
Pressure Out	1.31	1.31

Press <-> Arrows to Increase/Decrease

Use the left/right arrow keys to increase/decrease values until the values displayed by the Green Field DC are equal to the values indicated on the reference pressure sensor.

14.7 Weather Station Calibration

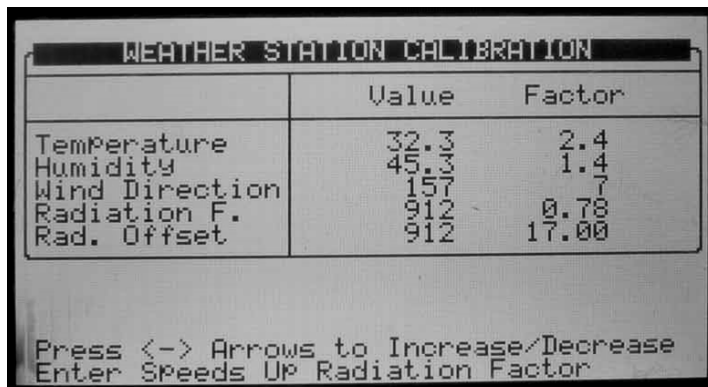

	Value	Factor
Temperature	32.3	2.4
Humidity	45.3	1.4
Wind Direction	157	7
Radiation F.	912	0.78
Rad. Offset	912	17.00

Press <-> Arrows to Increase/Decrease
Enter SPEEDS UP Radiation Factor

Use the left/right arrow keys to increase/decrease values.

- For temperature and humidity sensors calibration can be done using reference temperature and humidity sensors.
- Wind direction sensor should be calibrated so that the value indicated by the Green Field DC fits the actual direction pointed by the wind direction sensor.
- The radiation sensor factor should be set as indicated in the calibration sticker supplied with the sensor. The radiation offset should be set to 17 unless specified otherwise.

NOTE See Green Field DC Irrigation: Part 2 > Sensor specifications > Weather sensor specifications for additional information.

14.8 Sensors Logging

The Sensors Logging screen allows you to define which sensors should be logged.

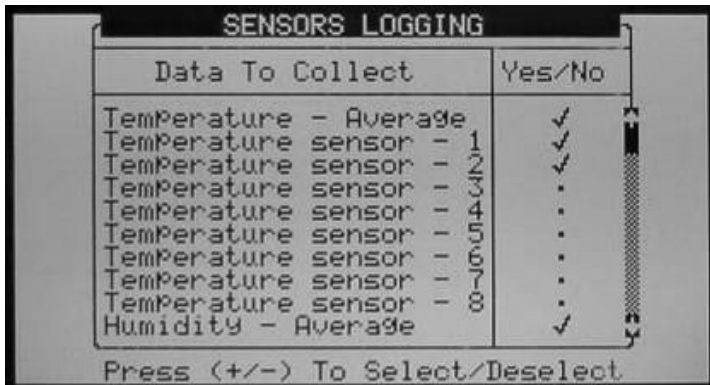

To select an item move the cursor using the arrow keys and mark it using the '+/-' key. Selected items are marked with ✓.

NOTE When you change the sensors logging setup, the sensors history table resets and starts over; all sensors data accumulated on the controller is lost.

14.9 Write to Data Plug

The data-plug can be used to save controller settings, and restore them when needed.

Plug the data-plug into the Green Field DC data-plug socket (see Figure on next page).

The data-plug is symmetric so it can be plugged in both directions.

Enter the WRITE TO DATA PLUG screen and confirm your choice.



NOTE When writing to a data-plug, old data on the data-plug will be overwritten.

14.10 Read from Data Plug

The data-plug can be used to upload and restore controller settings when needed.

Plug the data-plug into the Green Field DC data-plug socket (see the figure below).

Data-plug

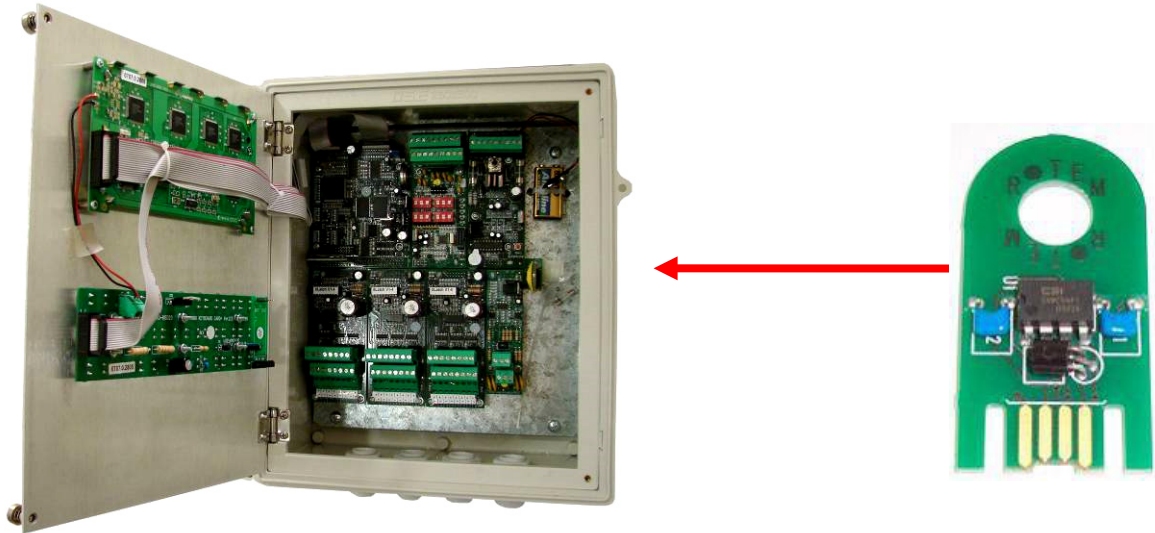

NOTE The Data plug should be used when the system is idle; otherwise, some of the running programs might be interrupted and moved to halt.

Enter the READ FROM DATA PLUG screen and confirm your choice.



NOTE When reading from the data-plug, the current settings data on the controller will be overwritten.

[14.11 Edit SMS Phonebook](#)

N/A

[14.12SMS Setup](#)

N/A

[14.13SMS Personal Message](#)

N/A

15 Configuration

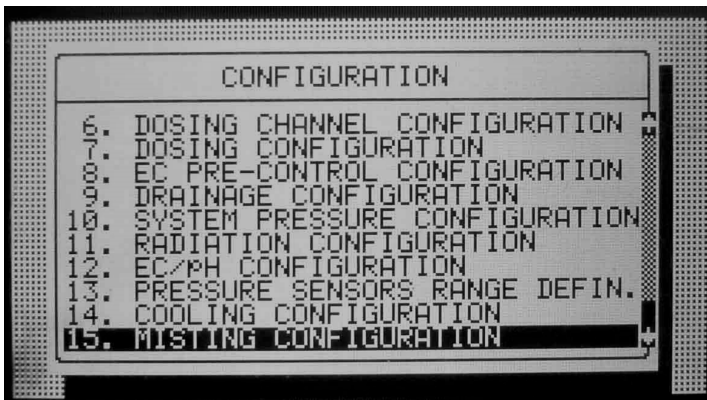
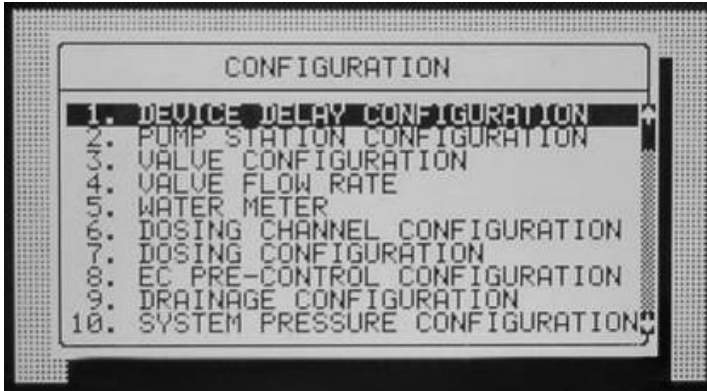

- Device Delay Configuration
- Pump Station Configuration
- Valve Configuration
- Valve Flow Rate
- Water Meter
- Dosing Channel Configuration
- Dosing Configuration
- EC Pre-Control Configuration
- Drainage Configuration
- System Pressure Configuration
- EC/pH Range Definition
- Pressure Sensor Range Definition
- Cooling Configuration
- Misting Configuration

15.1 Device Delay Configuration

The Device Delay Configuration screen allows you to define the startup and shutdown order of the irrigation process.

DEVICE DELAY CONFIGURATION		
	On mm:ss	Off mm:ss
Pump	--:--	00:35
Main Valve	01:00	00:15
Valve	01:30	--:--
IN-PROGRAM DELAYS		
Shift delay (sec)		-30
Stagger delay (sec)		20

- On (mm:ss): On is the definition of the startup order. The set times are taken from procedure startup. The device with the shortest time will be started first and shifted to procedure startup. Therefore it is recommended that the device that is to be started first be set as 00:00 (automatically changes to --:--).
- Off (mm:ss): Off is the definition of the shutdown order of the irrigation process. The set times are taken from procedure shutdown. The device with the shortest time will be stopped first and shifted to procedure shutdown. Therefore it is recommended that the device that is to be stopped first be set as 00:00 (automatically changes to --:--).

Example of device startup & shutdown order:

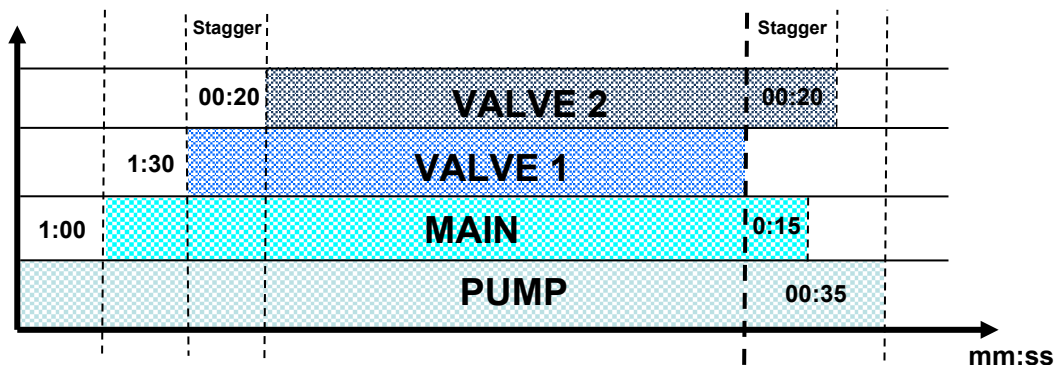

- Startup: According to the settings above, the pump will be turned on first (on procedure startup). The main valve will be opened after 1 minute and 30 seconds later (1:30 minutes from procedure startup) the valve.
- Shutdown: According to the settings above the valve will be turned off first (on procedure shutdown). The main valve will be closed after 15 seconds and the pump will be closed 20 seconds later (35 seconds from procedure shutdown).

NOTE It is recommended that the device that should be started (stopped) first be defined as zero (will appear as --:--).

IN-PROGRAM DELAYS

- Shift delay (sec): Define the time (in seconds) between each valve change. The shift delay can also be a shift advance by inserting a negative value. This means that the next valve will start before the previous one.

- Stagger delay (sec): Define the time (in seconds) for the first shift and the last shift delay between valves (inside of group).

Example of Stagger valve delay: multiple shifts

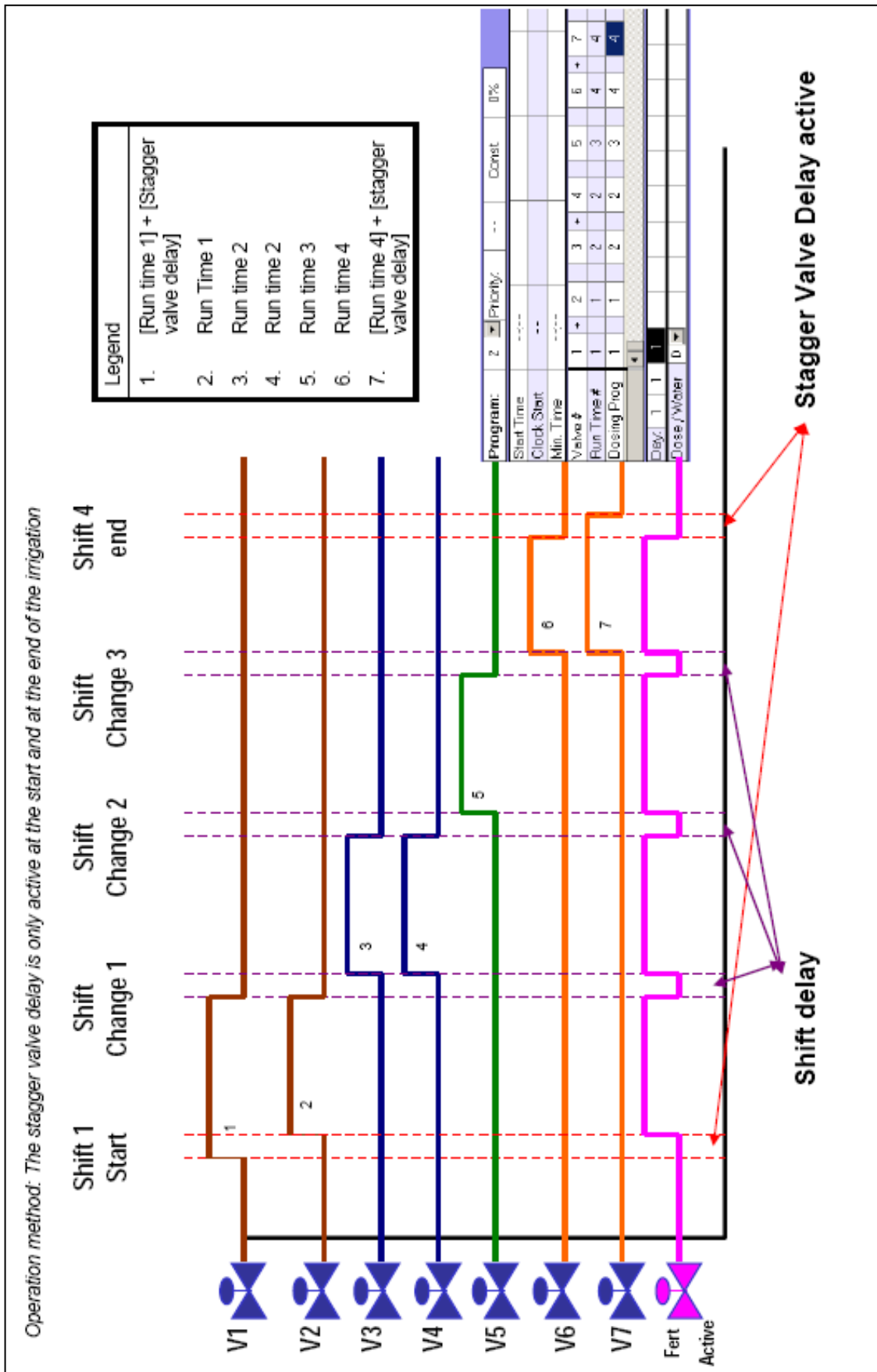

15.2 Pump Station Configuration

The Green Field DC can include up to 6 pumps. Each valve (irrigation, cooling or misting) can be connected to one of the pumps or to the pump station. The pump station is a group of pumps (out of the six possible pumps) that will be started in accordance with the required flow.

The Pump Station configuration screen allows you to define which pumps are part of the station, the capacity of the various pumps and their startup and shutdown delays.

The Green Field DC automatically calculates the expected flow and determines which pump (or pumps) should be started (see Valve Configuration for additional information regarding flow calculation). The Green Field DC will start the minimal number of pumps required to supply the calculated flow rate.

If several pumps should be started, the Green Field DC will start from the largest to the smallest and will turn them off from the smallest to the largest.

- Pump No.: Pump number.
- Capacity: Define pump capacity in m³ or gallon. This will be the maximum pump capacity, above which the Green Field DC will turn on another pump (if available).
- Stability (mm:ss): Define stability time. Stability time is the startup time required for current pump before next pump can be started up. Stability time is usually used to prevent voltage drop down and water hammer (see Pump Startup Order schema).
- Off Delay (mm:ss): Define off delay. Off delay will be the delay time for current pump to stop after last pump has stopped. This delay is usually used to prevent water hammer (see Pump Shutdown Order schema).
- Station (Yes/No): Define whether the pump is part of the pump station.

The following is a startup and shutdown order schema according to the settings above and a calculated flow rate of 60 m³/h:

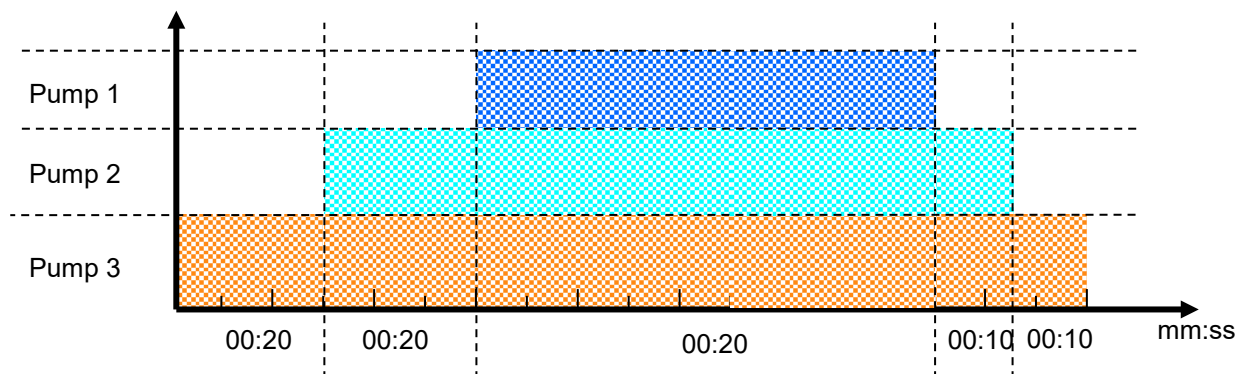

Pump startup & shutdown order

15.3 Valve Configuration

Valve configuration allows you to configure devices such as pumps, main valves and drainage measurement of valves.

VALVE CONFIGURATION				
Valve No.	Pump	Main Valve	Water Meter	Drain Meter
115	Pump 2	1	2	2
116	Station	1	1	1
117	Pump 3	1	3	3
118	Station	1	1	1
119	Pump 4	1	4	4
120	Station	1	1	1
121	Pump 2	1	2	1
122	Station	1	1	1
123	Station	1	1	1
124	Pump 4	1	1	1

VALVE CONFIGURATION				
Valve No.	Main Valve	Water Meter	Drain Meter	Drain Type
115	1	2	2	Sample
116	1	1	1	Total
117	1	3	3	Sample
118	1	1	1	Total
119	1	4	4	Sample
120	1	1	1	Total
121	1	2	1	Total
122	1	1	1	Total
123	1	1	1	Total
124	1	1	1	Total

VALVE CONFIGURATION				
Valve No.	Water Meter	Drain Meter	Drain Type	Sample %
115	2	2	Sample	50.0000%
116	1	1	Total	-----
117	3	3	Sample	80.0000%
118	1	1	Total	-----
119	4	4	Sample	100.0000%
120	1	1	Total	-----
121	2	1	Total	-----
122	1	1	Total	-----
123	1	1	Total	-----
124	1	1	Total	-----

- Valve No.: Indication of the valve number.
- Pump: Define which pump or pump station should be started when irrigating this valve. When choosing Station, the Green Field DC will choose which and how many pumps should be started to supply the required (calculated) flow. See PUMP STATION CONFIGURATION on page XX for more information).
- Main Valve: Define which main valve should be opened when starting each valve.
- Water Meter: Configure a water meter to each valve. This option is only possible when the flow calculation (water meter type) is Standard.

NOTE Make sure that you define an operative water meter. There is no protection against defining a water meter that isn't properly defined in the system.

Note that when operating by Water Source (unlike Standard, in table 7.5) a valve is not configured to a specific water meter. In this case, all water meters set in the system are relevant for each irrigation and their pulses are calculated for the flow rate, hence, water meter column will be ignored in valve configuration table.

NOTE Make sure that you define an operative water meter. There is no protection against defining a water meter that isn't properly defined in the system.

NOTE When using more than one water meter it is recommended not to start to valves that are not configured to the same water meter simultaneously; the Green Field DC uses only the water meter connected to the leading valve and does not sum the flow from the rest of the water meters, this might create unexpected alarms and malfunctions!

- Drain Meter: Define which drain meter this valve is connected to.
- Drain Type: Define drainage type:
 - Total: Drainage is collected from the complete valve area.
 - Sample: Drainage is collected from a representing part of the valve area.

Note that it is possible to set several valves to the same drain meter when working by 'Total'. The system does not allow operating several valves on the same meter when operating by 'Sample'.

- Sample %: When using sample drainage measurement it is required to define the ratio of the sample area to the complete valve area.

15.4 Valve Flow Rate

VALVE FLOW RATE			
Valve No.	Nominal m ³ /h	Minimum m ³ /h	Maximum m ³ /h
51	5.000	3.750	6.250
52	19.000	14.250	23.750
53	20.000	15.000	25.000
54	22.000	16.500	27.500
55	13.000	9.750	16.250
56	15.000	11.250	18.750
57	22.000	16.500	27.500
58	30.000	22.500	37.500
59	11.000	8.250	13.750
60	14.000	10.500	17.500

VALVE FLOW RATE			
Valve No.	Nominal m ³ /h	Minimum m ³ /h	Maximum m ³ /h
246	5.000	3.750	6.250
247	13.000	9.750	16.250
248	16.000	12.000	20.000
249	19.000	14.250	23.750
250	4.000	3.000	5.000
251	23.000	17.250	28.750
252	18.000	13.500	22.500
253	25.000	18.750	31.250
254	5.000	3.750	6.250
255	22.000	16.500	27.500

- **Nominal:** Define nominal valve flow rate (m³/h or gallon/min). The Green Field DC uses the set nominal flow rate for calculating the ratio between valves when starting a few valves together, the boundaries for alarms, the total flow rate for calculating how many pumps to start, etc. Therefore it is recommended to try and set the nominal flow rate as close as possible to the actual flow rate.
- **Minimum:** Minimum valve flow rate, under which the system will generate a low flow alarm. When changing the Nominal flow rate this setting is automatically set to 25% under the nominal flow, and can be manually changed.
- **Maximum:** Maximum valve flow rate, above which the system will generate a high flow alarm. When changing the nominal flow rate this setting is automatically set to 25% above the nominal flow, and can be manually changed.

NOTE When starting several valves simultaneously the system will sum their nominal, minimal and maximal flow rates. An alarm will be generated only if the measured flow rate is lower than the total minimum, or higher than the total maximum.

NOTE When starting several valves simultaneously, the quantities between them will be divided based on the ratio of their nominal flow.

15.5 Water Meter

- **Ratio:** Set volume per pulse of each water meter or auxiliary meter.
- **Type:** Define type of flow calculation:
 - **Standard:** In this function valves which are operated in a group should be connected to the same water meter.

NOTE If a few valves configured to different water meters will be started simultaneously, the Green Field DC uses the flow measured by the water meter connected to the leading valve.

- Water source: The Green Field DC will sum or deduct flow measured simultaneously from a few water meters. When choosing this function an additional column called "SUM" will appear, this column enables to define which water meters should be summed and which deducted from the total measured flow.

NOTE Flow calculation type is a general definition for all water meters, therefore when changing type of water meter for one of the water meters the type will be changed for all water meters.

NOTE When setting flow calculation (water meter type) to Water source it is not possible to configure valves to water meters.

- Sum: Define whether flow measured by each water meter should be added to the total measured flow or deducted:
- "+" Flow measured by this water meter will be added to the total measured flow.
- "-" Flow measured by this water meter will be deducted from the total measured flow.

NOTE Since flow cannot be negative, if the controller measures negative flow it will show zero.

NOTE If all valves are set to "-" the system will ignore the measured flow and will use the calculated flow (based on the nominal flow).

The image shows three screenshots of the 'WATER METER' configuration screen. Each screen displays a table with columns for Description, Ratio, Type, and Sum.

Description	Ratio	Type	Sum
Water Meter 1 (L/P)	10.000	W.SOURCE	
Water Meter 2 (L/P)	20.000	W.SOURCE	
Water Meter 3 (L/P)	50.000	W.SOURCE	
Water Meter 4 (L/P)	100.000	W.SOURCE	
Water Meter 5 (L/P)	10.000	W.SOURCE	
Water Meter 6 (L/P)	-----	W.SOURCE	
AUX Meter 1 (L/P)	-----	-----	-----
AUX Meter 2 (L/P)	-----	-----	-----
AUX Meter 3 (L/P)	-----	-----	-----
AUX Meter 4 (L/P)	-----	-----	-----
AUX Meter 5 (L/P)	-----	-----	-----

Description	Type	Sum
Water Meter 1 (L/P)	W.SOURCE	+
Water Meter 2 (L/P)	W.SOURCE	+
Water Meter 3 (L/P)	W.SOURCE	+
Water Meter 4 (L/P)	W.SOURCE	+
Water Meter 5 (L/P)	STANDARD	-
Water Meter 6 (L/P)	W.SOURCE	+
AUX Meter 1 (L/P)	-----	-----
AUX Meter 2 (L/P)	-----	-----
AUX Meter 3 (L/P)	-----	-----
AUX Meter 4 (L/P)	-----	-----
AUX Meter 5 (L/P)	-----	-----

Description	Ratio	Type
Water Meter 1 (L/P)	10.000	STANDARD
Water Meter 2 (L/P)	20.000	STANDARD
Water Meter 3 (L/P)	50.000	STANDARD
Water Meter 4 (L/P)	100.000	STANDARD
Water Meter 5 (L/P)	10.000	STANDARD
Water Meter 6 (L/P)	-----	STANDARD
AUX Meter 1 (L/P)	-----	-----
AUX Meter 2 (L/P)	-----	-----
AUX Meter 3 (L/P)	-----	-----
AUX Meter 4 (L/P)	-----	-----
AUX Meter 5 (L/P)	-----	-----

- It is very important to choose the correct flow meter for the application. Choosing a wrong flow meter might result in measurement errors or an inaccurate control. For instructions regarding how to choose the correct water meter see Green Field DC Irrigation > General > Flow meter determination.

15.6 Dosing Channel Configuration

DOSING CHANNEL CONFIGURATION			
No.	Pump	Method	Ratio
1	Venturi	Time(Lit/h)	150.000
2	Venturi	Time(Lit/h)	200.000
3	Venturi	Time(Lit/h)	300.000
4	Venturi	Time(Lit/h)	300.000

DOSING CHANNEL CONFIGURATION			
No.	Ratio	React	High(%)
1	150.000	EC	50
2	200.000	EC	50
3	300.000	ACID	50
4	300.000	PASSIVE	---

DOSING CHANNEL CONFIGURATION			
No.	High(%)	Low(%)	U/P(L)
1	80	80	0.1000
2	50	50	-----
3	50	50	-----
4	---	---	-----

- Pump - Select the type of dosing pump:
 - Venturi: The dosing unit consists of venturi driven injectors. The dosing booster will be turned on when fertigation is active.
 - Hydraulic: The dosing unit consists of hydraulic fertilizer pumps. The dosing booster is not needed and will not be turned on when Fertigation is active. When working with hydraulic pump, the method can only be Liter/Pulse and EC & pH control is not possible.
 - Electric: The dosing unit consists of electrical fertilizer pumps. The dosing booster is not needed and will not be turned on when Fertigation is active.
- Method - Select the operating method:
 - Liter/Pulse: Define whether a dosing meter is connected to this channel and used for control purposes. Set the volume per pulse on the Ratio column.
 - Time (cc/sec): Define whether the calculated flow rate of the dosing channel is in CC (gallons) of fertilizer per second.
 - Time (Liter/min): Define whether the calculated flow rate of the dosing channel is in liters (gallons) per minute.
 - Time (Liter/Hour): Define whether the calculated flow rate of the dosing channel is in liters (gallons) per Hour.
- Ratio
 - Method is Time - Define calculated flow rate, this will be the flow rate of the channel when completely open.
 - Method is Liter/Pulse: Define the volume per pulse.
- React - Set the required use of the channel:
 - EC: The channel is used to increase measured EC, meaning it will be opened more when the measured EC is lower than the set EC.
 - pH: The channel is used to decrease measured pH, meaning it will be opened more when the measured pH is higher than the set pH.
 - Passive: The channel does not respond to changes in measured EC/pH, meaning it will be opened as set in the dosing program regardless of the EC/pH values.
 - Alkali: The channel is used to increase measured pH, meaning it will be opened more when the measured pH is lower than the set pH.

NOTE If EC/pH control is off, or the channel is used for proportional injection only (for example in order to inject chemicals) set reaction to passive.

- High % - set an injection percentage limit. This percentage will limit the deviation from set dosing recipe when Green Field DC is injecting more than specified in order to try and reach the target EC/pH values.

- Low % - set an injection percentage limit. This percentage will limit the deviation from set dosing recipe when Green Field DC is injecting less than defined in order to try and reach the target EC/pH values.
- V/P(L/G): This parameter will be disabled when operating by Liter/Pulse. Define the volume per pulse of the dosing meter (liters or gallons). Only required when using a dosing meter for measurement and alarm purposes. When using a dosing meter for control purposes the volume per pulse of the dosing meter should be defined on the Ratio column. The letter between the brackets indicates whether the volume units are in Liter or Gallon.

15.7 Dosing Configuration

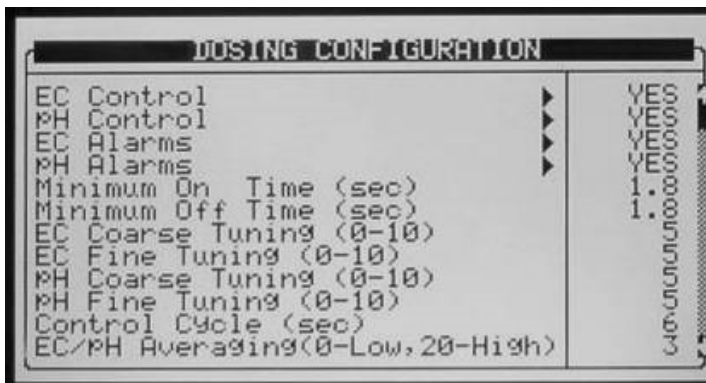

- EC Control: Define whether EC control should be operative.
- pH Control: Define whether pH control should be operative.
- EC Alarms: Define whether EC related alarms are operative. When EC control is set to 'Yes', EC Alarms are automatically set to 'Yes' and cannot be changed.
- pH Alarms: Define whether pH related alarms are operative. When pH control is set to 'Yes' pH Alarms are automatically set to 'Yes' and cannot be changed.
- Minimum On Time (sec): Define the minimum time the dosing regulator may be opened for. This feature is used to protect the regulator from being excessively turned on and off. The minimum allowed on time is 0.4 seconds.
- Minimum Off Time - Define the minimum time the dosing regulator may be turned off. This feature is used to protect the regulator from being excessively turned on and off. The minimum On time allowed is 0.4 seconds.
- EC Coarse Tuning (0-10): EC Coarse Tuning is used to adjust the speed and strength of the EC control. A higher value will result in faster correction but might lead to over shooting (see Appendix 1: General > EC/pH correction adjustment for further information).
- EC Fine Tuning (0-10): EC Fine Tuning is used to fine tune the EC control shooting (see Green Field DC Irrigation > Part 2 > General > EC/pH correction adjustment for further information).
- pH Coarse Tuning (0-10): pH Coarse Tuning is used to adjust the speed and strength of pH control. A higher value will result in faster correction but might lead to over shooting (see Green Field DC Irrigation > Part 2 > General > EC/pH correction adjustment for further information).

- pH Fine Tuning (0-10): pH Fine Tuning is used to fine tune pH control shooting (see Green Field DC Irrigation > Part 2 > General > EC/pH correction adjustment for further information).
- Control Cycle (sec): Define the control cycle for EC/pH control. This should be the time it takes the system since it injected fertilizer/acid until the change in recognized by the system.
- EC/pH Averaging (0-Low, 20-High) - Averaging factor for EC/pH measurement. EC/pH averaging should be used to enable correction when injection is not homogenous.
- Dosing Booster Off Delay (mm:ss): Define the time that the dosing booster should be left on after dosing has ended. This time is usually used to circulate the acid and nutrients in order to prevent high concentrations in the area of the venturies and dosing booster when the system is idle.
 - Dosing by QTY. Method:
 - Bulk: All channels set to QTY (quantity) dosing method will inject the set quantity in one bulk, starting after water before quantity/time has elapsed.
 - Spread Out: The set dosing quantity of all channels set to QTY (quantity) dosing method will be spread throughout the irrigation.

15.8 EC Pre-Control Configuration

EC Pre-Control Configuration	
EC Pre-Control Runtime	01:50
EC Pre-Control Control Cycle	00:06
Coarse Tuning	5
Fine Tuning	5
EC Pre-Control Pump	
Start With First/Last Device ▶	First
Off Delay	00:15

- EC Pre-Control Configuration:
 - EC Pre-Control Runtime: Set the time it takes the EC Pre-Control valve to shift from fully closed to fully open. This parameter is very important and must be exact as the controller uses this parameter to calculate the opening percentage of the EC Pre-Control valve.
 - EC Pre-Control Control Cycle: Set the time it takes since the EC Pre-Control valve changes position until the change is measured by the EC Pre-Control sensor.
 - Coarse Tuning - Coarse Tuning is used to adjust control speed and strength. A higher value will result in faster correction but might lead to over-closing, a lower value might result in slow reaction.
 - Fine Tuning - Fine Tuning is used to fine tune EC Pre-Control behavior.
- EC Pre-Control Pump:

- Start With First/Last Device: Define whether the EC Pre-Control Pump should open with the first or the last device of the irrigation (refer to table 1.3 to see device startup order).
- Off Delay: Define Off delay (if required) for the EC Pre-Control pump.

15.9 Drainage Configuration

DRAINAGE CONFIGURATION			
Meter No.	Ratio Liter/Pulse	On Delay	Off Delay
1	1.000	00:01:00	00:03:00
2	1.000	00:06:00	00:05:00
3	1.000	00:10:00	00:10:00
4	-----	--:--:--	--:--:--
5	-----	--:--:--	--:--:--
6	-----	--:--:--	--:--:--
7	-----	--:--:--	--:--:--
8	-----	--:--:--	--:--:--

- Ratio: Define volume per pulse of the drainage meters (liter/pulse or gallon/pulse).
- On Delay: Define how long a valve, which is configured to this drainage measurement, should be open before the measured drainage is related to this valve. All drainage measured before this time has elapsed (although the valve is open) will still be related to the previous opened valve that was configured to this drainage sump.
- Off Delay: Define how long after irrigation has finished, the measured drainage should still be related to the previous irrigation. This value is used to “tell” the Green Field DC when to stop relating drainage to the previous irrigation and write it to all relevant history tables.

15.10 System Pressure Configuration

SYSTEM PRESSURE CONFIGURATION

Low Pressure Alarm ▶ B. In Sensor

None
P. In Sensor
 P. Out Sensor

- Define which pressure sensor (inlet or outlet) should be used as the system’s pressure. This sensor can later be defined to stop the system in case of low pressure (see table 1.7).

15.11 EC/pH Range Definition

EC/pH CONFIGURATION			
Sensor	4 mA	20 mA	Sensor Dif.
EC 1	0	10	
pH 1	0	14	
EC 2	0	10	----
pH 2	0	14	----
EC P	0	20	
EC Control Sensor	▶		EC 1+EC 2
pH Control Sensor	▶		pH 1+pH 2

- Define the range of the EC/pH transmitters.
- Default settings for EC/pH transmitters are:
 - EC: zero to 10 mS
 - PH: zero to 14 ppm
- EC Control Sensor: Define which EC sensor should be used for control. When setting EC 1 + EC 2, EC1 will be used for control, and EC2 will be used for verification.
- pH Control Sensor: Define which pH sensor should be used for control. When setting pH 1 + pH 2, pH1 will be used for control, and pH2 will be used for verification.

15.12 Pressure Sensor Range Definition

PRESSURE SENSORS RANGE DEFINITION		
Sensor ▶	0 Volt	5 Volt
Pin (bar)	0.00	10.00
Pout (bar)	0.00	10.00

0 Volt
4 mA

- 0: 5 Volt or 4: 20 mA - Use the arrow keys to move the cursor to the 0 Volt (4 mA), press ENTER to switch between 0: 5 Volt and 4: 20 mA.
- 0 Volt (4 mA): Define the pressure (bar or PSI) that should be presented when 0 volts (4 mA) is read by the Green Field DC.
- 5 Volt (20 mA): Define the pressure (bar or PSI) that should be presented when 5 Volts (20 mA) is read by the Green Field DC.

The Green Field DC will create a linear graph between the 0 Volt (4 mA) to the 5 Volt (20 mA).

15.13 Cooling Configuration

The cooling configuration screen will only be visible after one (or more) cooling valves have been defined in the DEVICE LAYOUT table.

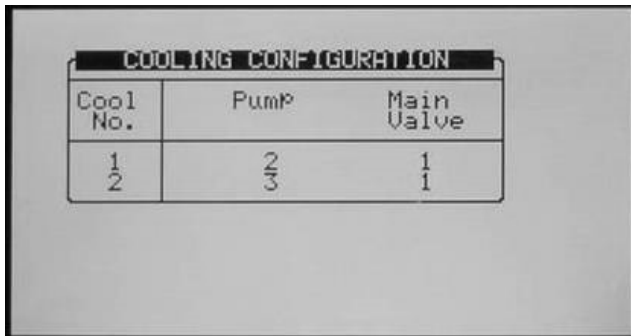

Cool No.	Pump	Main Valve
1 2	2 3	1 1

- Pump: Configure a pump to each cooling valve. This setting is not necessary if the cooling pump is not controlled by the Green Field DC.
- Main Valve: Configure a main valve to each cooling valve. This setting is not necessary if the cooling doesn't have a main valve.

15.14 Misting Configuration

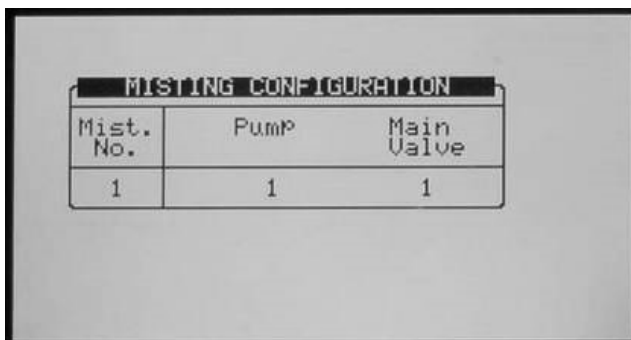

Mist. No.	Pump	Main Valve
1	1	1

- Pump: Configure a pump for each misting valve. This setting is not necessary if the misting pump is not controlled by the Green Field DC.
- Main Valve: Configure a main valve to each misting valve. This setting is not necessary if the misting doesn't have a main valve.

16 Installation



- Device Layout
- Device List
- Digital Input
- Analog Input 1-2
- Hardware Checklist

16.1 Device Layout

The device layout screen allows you to assign functions to each output (relay).

1. Place the cursor on the Function column, use the arrow keys to reach the relevant line, and press ENTER. A selection list including all available devices will appear.
 2. Choose the required device and confirm by pressing ENTER. The cursor will move to the No. column.
 3. Specify the number of the device in the controller and press ENTER to confirm.
 4. If you wish to define several devices of the same type, e.g., valves 1 to 10, configure the first one and press ENTER a few times until you reach the required amount. The Green Field DC automatically continues with the same device until instructed otherwise, or until reaching the system limitation for that device.
- Relay: This column is divided to two sub-columns indicating relay number and the location of the relay card;
 - Local: Numbers 1 to 64 and the card exists.
 - EXT 1: Numbers 65 to 128 and the card exists.
 - EXT 2: Numbers 129 to 196 and the card exists.
 - EXT 3 - Numbers 197 to 256 and the card exists.

NOTE If the card does not exist, the column can show either 'N/A' (see Screen 4 on next page) or 'R.U.' (see Screen 5 on next page), according to parameter "Remote Unit Type" in table 6.2.

NOTE If a selected value will be different than 'None' in table 6.2, 'R.U.' will be displayed in this table (see Screen 5 on next page).

NOTE If 'SingleNet' is chosen in table 6.2, the screen will consist of 256 outputs.

NOTE If 'Radio' is selected in table 6.2, the screen will contain at least 64 outputs.

Screen 1

DEVICE LAYOUT			
Relay		Function	No.
LOCAL	1	Dosing Channel	1
LOCAL	2	Dosing Channel	2
LOCAL	3	Dosing Channel	3
LOCAL	4	Dosing Channel	4
LOCAL	5	Dosing Channel	5
LOCAL	6	Dosing Channel	6
LOCAL	7	Dosing Channel	7
LOCAL	8	Dosing Channel	8
LOCAL	9	Dosing Booster	1
LOCAL	10	Pump	1

Screen 2

DEVICE LAYOUT			
Relay		Function	No.
LOCAL	62	Same As Relay	11
LOCAL	63	Same As Relay	12
LOCAL	64	Same As Relay	13
EXT1	65	Valve	51
EXT1	66	Valve	52
EXT1	67	Valve	53
EXT1	68	None	---
EXT1	69	None	---
EXT1	70	None	---
EXT1	71	None	---

Screen 3

DEVICE LAYOUT			
Relay		Function	No.
EXT1	125	None	---
EXT1	126	None	---
EXT1	127	Same As Relay	11
EXT1	128	Valve	54
EXT2	129	Valve	115
EXT2	130	Valve	116
EXT2	131	Valve	117
EXT2	132	None	---
EXT2	133	None	---
EXT2	134	None	---

Screen 4

DEVICE LAYOUT			
Relay		Function	No.
N/A	247	None	---
N/A	248	None	---
EXT3	249	None	---
EXT3	250	None	---
EXT3	251	None	---
EXT3	252	None	---
EXT3	253	None	---
EXT3	254	None	---
EXT3	255	Same As Relay	13
EXT3	256	Valve	255

Screen 5

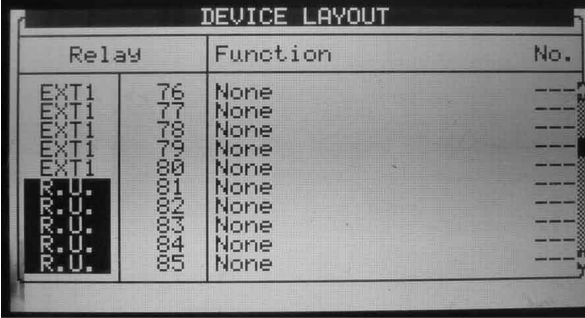

Relay	Function	No.
XT1	76	None
XT1	77	None
XT1	78	None
XT1	79	None
XT1	80	None
U.	81	None
U.	82	None
U.	83	None
U.	84	None
U.	85	None

After making changes, be sure to exit and return again to check for errors. The Green Field DC will delete and replace conflicting assignments with '---'.

16.2 Device List

The Device List screen allows you to view what type, and how many devices are currently defined. This screen automatically updates depending on the devices set in the 7.1 screen.

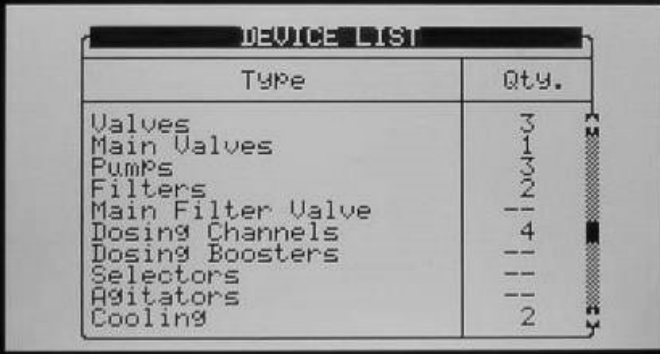

Type	Qty.
Valves	3
Main Valves	1
Pumps	1
Filters	2
Main Filter Valve	1
Dosing Channels	4
Dosing Boosters	1
Selectors	1
Agitators	1
Cooling	2

16.3 Digital Input

Place the cursor on the relevant line and press ENTER. A selection list will open. Choose the required sensor and press ENTER to confirm.

Inputs 1-32 are according to the following:

- Card no. 1: inputs 1: 8
- Card no. 2: inputs 9: 16
- Card no. 3: inputs 17: 24
- Card no. 4: inputs 25 - 32

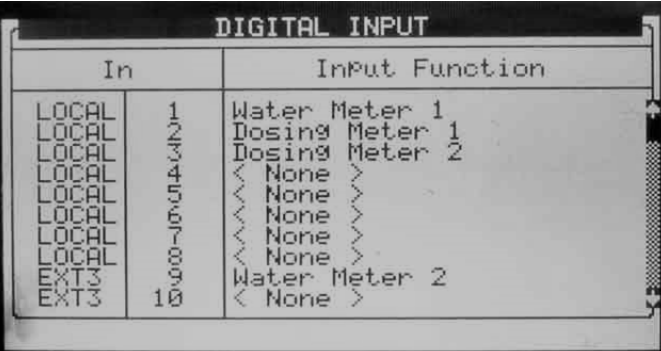

In	Input Function
LOCAL 1	Water Meter 1
LOCAL 2	Dosing Meter 1
LOCAL 3	Dosing Meter 2
LOCAL 4	< None >
LOCAL 5	< None >
LOCAL 6	< None >
LOCAL 7	< None >
LOCAL 8	< None >
EXT3 9	Water Meter 2
EXT3 10	< None >

DIGITAL INPUT		
In		Input Function
EXT1	17	Water Meter 3
EXT1	18	External Pause
EXT1	19	< None >
EXT1	20	< None >
EXT1	21	< None >
EXT1	22	< None >
EXT1	23	< None >
EXT1	24	< None >
EXT2	25	Water Meter 4
EXT2	26	Delta Pressure

- Note that if the cards do not exist, either 'N/A' or 'R.U' will be displayed, according to parameter "Remote Unit Type" in table 6.2.
- This table refers to both local and extension boxes.
- Note that the card number is set according to its jumpers regardless to its location (local or extension box).

16.4 Analog Input 1-2

Place the cursor on the Input Function column, use the arrow keys to reach the relevant line, press ENTER, a selection list including all available analog sensors will appear, choose the required sensor and confirm by pressing ENTER. The cursor will jump to the No. column, define the number of the sensor in the controller and press enter to confirm.

ANALOG INPUT No. 1		
Channel	Input Function	No.
1	Temp. Sensor	1
2	Temp. Sensor	2
3	< None >	-
4	EC Sensor	1
5	pH Sensor	1
6	EC Sens. Verify	2
7	pH Sens. Verify	2
8	EC Pre-Control	1
9	Radiation	1
10	< None >	-
11	< None >	-

16.5 Hardware Checklist

Same as HARDWARE CHECK LIST screen from TEST section (Menu 6.6).

17 Controller Advanced Settings

- Pump Station Configuration
- Multiple Water Meters
- Drain Meter Measurement
- Drainage Timing
- Drain Log
- Various Dosing Channel Configurations
- Dosing Configuration
- Dual EC/pH Sensors
- Advanced System Setup
- Hot Keys And Status Screens
- Operation Mode

17.1 Pump Station Configuration

1 Main menu: 1. Program, 2. Manual, 3. Alarm, 4. History, 5. Water Meter, 6. Setup, 7. Config, 8. Install. **SELECT** button.

2 CONFIGURATION menu: 1. DEVICE DELAY CONFIGURATION, 2. PUMP STATION CONFIGURATION, 3. VALVE CONFIGURATION, 4. VALVE FLOW RATE, 5. WATER METER, 6. DOSING CHANNEL CONFIGURATION, 7. DOSING CONFIGURATION, 8. EC PRE-CONTROL CONFIGURATION, 9. DRAINAGE CONFIGURATION, 10. SYSTEM PRESSURE CONFIGURATION.

3 PUMP STATION CONFIGURATION table:

Pump No.	Capacity m3/h	Stability mm:ss	Off Delay mm:ss
1	50.000	--:--	--:--
2	70.000	00:10	00:10
3	80.000	00:15	00:15
4	100.000	--:--	--:--

4 PUMP STATION CONFIGURATION table:

Pump No.	Stability mm:ss	Off Delay mm:ss	Station
1	--:--	--:--	VP
2	00:10	00:10	VP
3	00:15	00:15	VP
4	--:--	--:--	NO

Pumps 1, 2 & 3 form a station

5 CONFIGURATION menu: 1. DEVICE DELAY CONFIGURATION, 2. PUMP STATION CONFIGURATION, 3. VALVE CONFIGURATION, 4. VALVE FLOW RATE, 5. WATER METER, 6. DOSING CHANNEL CONFIGURATION, 7. DOSING CONFIGURATION, 8. EC PRE-CONTROL CONFIGURATION, 9. DRAINAGE CONFIGURATION, 10. SYSTEM PRESSURE CONFIGURATION.

6 VALVE CONFIGURATION table:

Valve No.	Pump	Main Valve	Water Meter	Drain Meter
1	Pump 4	1	1	--
2	Pump 4	1	1	--
3	Station	2	2	--
4	Station	2	2	--
5	Station	2	2	--

Valves 1 & 2 allocated to Pump 4
Valves 3, 4 & 5 allocated to station of pumps 1, 2 & 3

17.2 Multiple Water Meters

- Option A: Standard Use/M Measurement
- Option B: Multiple Water Sources

17.2.1 OPTION A: STANDARD USE/MEASUREMENT

1 1. Program 2. Manual 3. Alarm 4. History
5. Test 6. Setup 7. Config 8. Install

2 CONFIGURATION
1. DEVICE DELAY CONFIGURATION
2. PUMP STATION CONFIGURATION
3. VALVE CONFIGURATION
4. VALVE FLOW RATE
5. WATER METER CONFIGURATION
6. DOSING CHANNEL CONFIGURATION
7. EC PRE-CONTROL CONFIGURATION
8. DRAINAGE CONFIGURATION
9. SYSTEM PRESSURE CONFIGURATION

3 WATER METER

Description	Ratio	Type
Water Meter 1 (L/P)	100.000	STANDARD
Water Meter 2 (L/P)	100.000	STANDARD
Water Meter 3 (L/P)	10.000	STANDARD
Water Meter 4 (L/P)	10.000	STANDARD
Water Meter 5 (L/P)	---	---
AUX Meter 1 (L/P)	---	---
AUX Meter 2 (L/P)	---	---
AUX Meter 3 (L/P)	---	---
AUX Meter 4 (L/P)	---	---
AUX Meter 5 (L/P)	---	---

Enter capacity and type for additional water meters

4 CONFIGURATION
1. DEVICE DELAY CONFIGURATION
2. PUMP STATION CONFIGURATION
3. VALVE CONFIGURATION
4. VALVE FLOW RATE
5. WATER METER CONFIGURATION
6. DOSING CHANNEL CONFIGURATION
7. EC PRE-CONTROL CONFIGURATION
8. DRAINAGE CONFIGURATION
9. SYSTEM PRESSURE CONFIGURATION

5 VALVE CONFIGURATION

Valve No.	Pump	Main Valve	Water Meter	Drain Meter
1	PUMP 1	1	1	---
2	PUMP 1	1	2	---
3	PUMP 1	1	3	---
4	PUMP 1	1	4	---

Configure meters to valves
Ex: Valves 3, 4 & 5 are allocated to water meters 2, 3 & 4 consecutively

17.2.2 OPTION B: MULTIPLE WATER SOURCES

- Used for water management, meters are located before the irrigation system

WATER METER

Description	Ratio	Type
Water Meter 1 (L/P)	100.000	W. SOURCE
Water Meter 2 (L/P)	100.000	W. SOURCE
Water Meter 3 (L/P)	10.000	W. SOURCE
Water Meter 4 (L/P)	10.000	W. SOURCE
Water Meter 5 (L/P)	---	---
Water Meter 6 (L/P)	---	---
AUX Meter 1 (L/P)	---	---
AUX Meter 2 (L/P)	---	---
AUX Meter 3 (L/P)	---	---
AUX Meter 4 (L/P)	---	---
AUX Meter 5 (L/P)	---	---

WATER METER

Description	TYPE	Sum
Water Meter 1 (L/P)	W. SOURCE	+
Water Meter 2 (L/P)	W. SOURCE	+
Water Meter 3 (L/P)	W. SOURCE	+
Water Meter 4 (L/P)	W. SOURCE	+
Water Meter 5 (L/P)	W. SOURCE	+
Water Meter 6 (L/P)	W. SOURCE	+
AUX Meter 1 (L/P)	---	---
AUX Meter 2 (L/P)	---	---
AUX Meter 3 (L/P)	---	---
AUX Meter 4 (L/P)	---	---
AUX Meter 5 (L/P)	---	---

Fresh Water, Tank 1, Tank 2, Drain Water, Water Meter 1, Water Meter 2, Water Meter 3, Water Meter 4

NOTE Cannot allocate a water meter to a valve.

17.3 Drain Meter Measurement

Drain applications for greenhouses.

- Option A: Total Measurement
- Option B: Sample Measurement

17.3.1 OPTION A: TOTAL MEASUREMENT

The diagram shows a greenhouse with a main pipe and several lateral pipes. A blue arrow labeled 'Total Flow' points to the main pipe.

Valve No.	Pump	Main Valve	Water Meter	Drain Meter
1	Pump	1	1	1

Valve No.	Water Meter	Drain Meter	Drain Sample %
1	1	1	Total
4	1	1	Sample
5	1	1	Sample
6	1	1	Sample
7	1	1	Sample

17.3.2 OPTION B: SAMPLE MEASUREMENT

The diagram shows a greenhouse with a main pipe and several lateral pipes. A blue arrow labeled 'Sample' points to one of the lateral pipes.

Valve No.	Main Valve	Water Meter	Drain Meter	Drain Type
1	1	1	1	Sample

Valve No.	Water Meter	Drain Meter	Drain Sample %
1	1	1	Sample 1.0000%
4	1	1	Sample 0.0000%
5	1	1	Sample 0.0000%
6	1	1	Sample 0.0000%
7	1	1	Sample 0.0000%

Meter No.	Ratio Liter/Pulse	On Delay	Off Delay
1	1.000	00:00:00	00:15:00

Collect sample from drain of 1 lateral=simulate the total amount of drain water per valve/shift

Measure delay:
 On delay= time it takes for water to get through the system.
 Off Delay= time after irrigation it takes for water to fully drain and stop drain measurement.

17.4 Drainage Timing

- Drainage Timing Option A
- Drainage Timing Option B

17.4.1 DRAINAGE TIMING OPTION A

When irrigating 1 valve which allocated to the a drain meter.

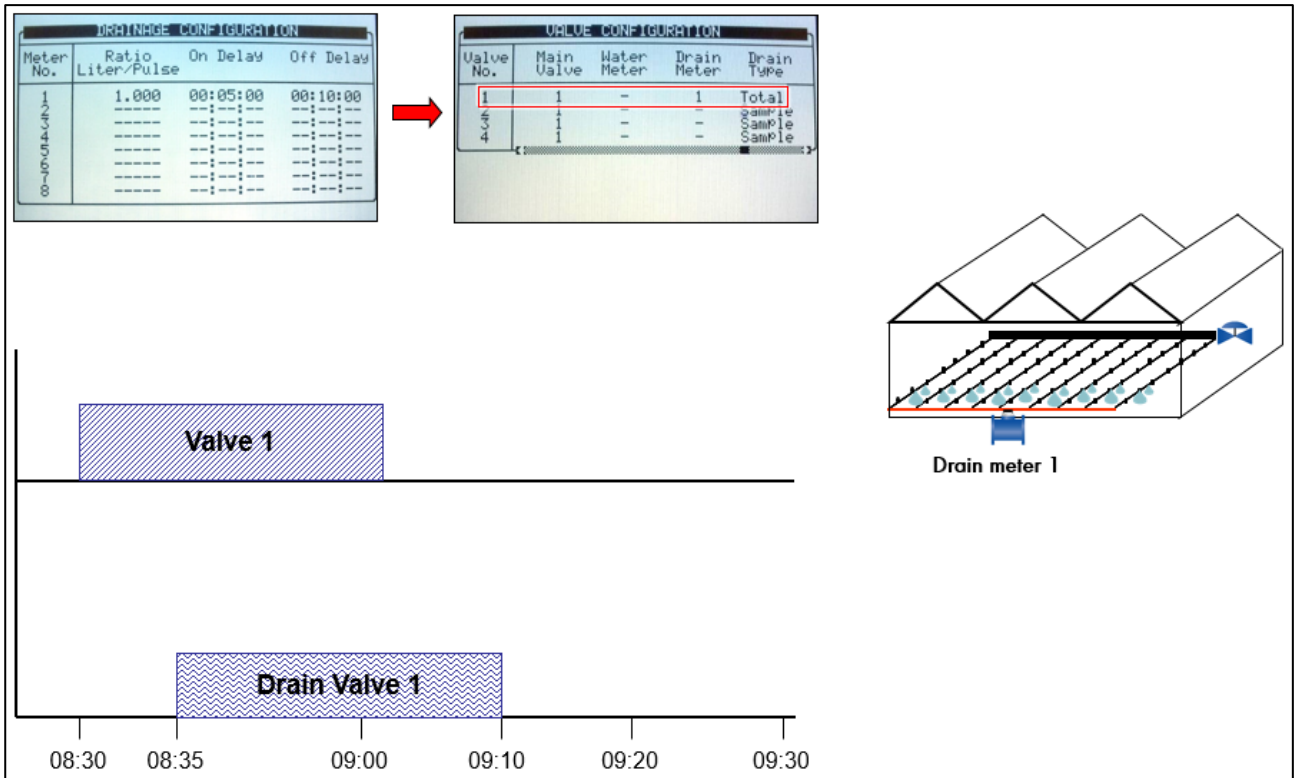

17.4.2 DRAINAGE TIMING OPTION B

When irrigating 2 consecutive valves which allocated to the same drain meter

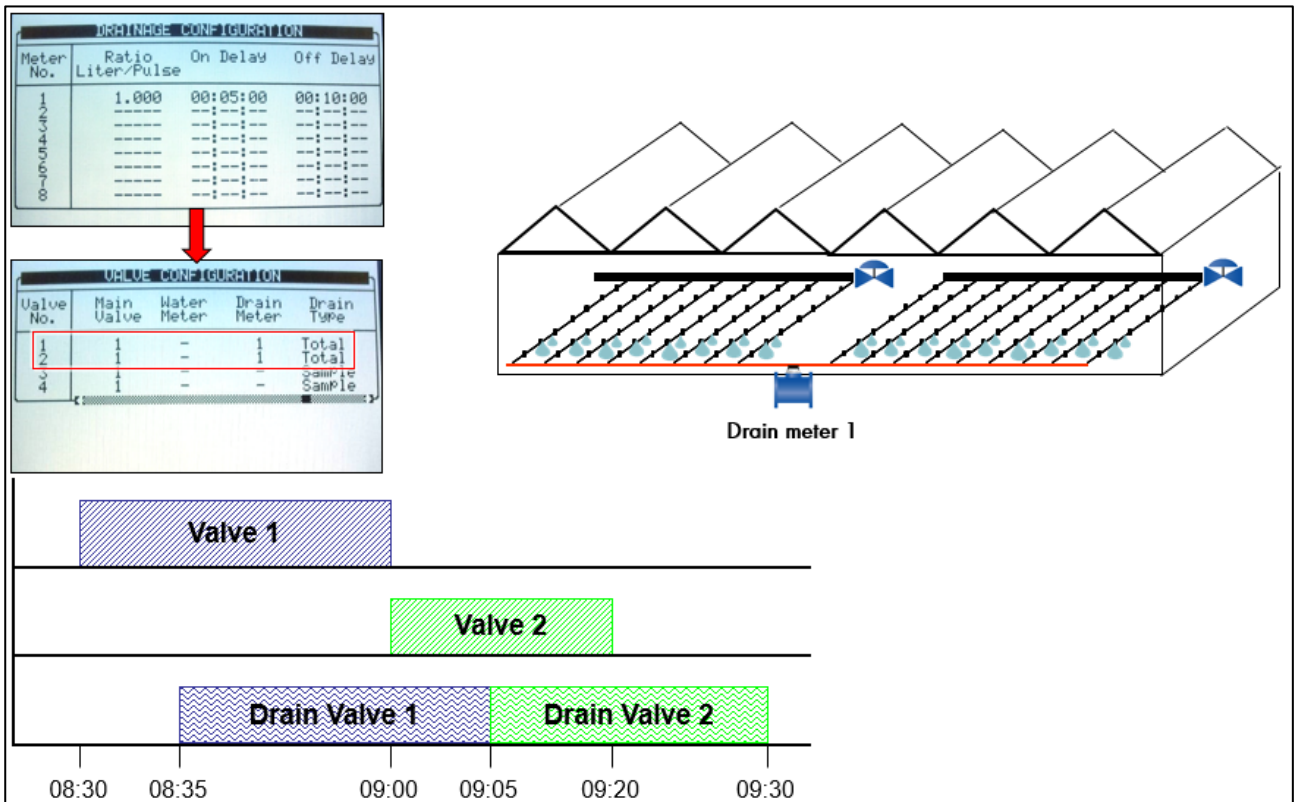

NOTE Valve 2 "On Delay" is taking control of valve 1 "Off Delay". Means that valve 1 drain measurement finished while valve 2 drain measurement just started

17.5 Drain Log

History Menu

1. IRRIGATION LOG
2. RAD. SUM & DRAIN LOG
 3. UNCOMPLETED IRRIGATION
 4. UNCOMPLETED PROGRAM
 5. DAILY IRRIGATION
 6. IRRIGATION ACCUMULATION
 7. WATER & AUX METER ACCO.
 8. ACCUMULATION RESET
 9. FILTERS
 10. COOLING

View drainage history log

Date	Time	U1	Drain %	Drain
20/Dec	17:26	254	100.00	1450
20/Dec	17:26	217	92.06	1300
20/Dec	17:26	117	78.57	1100
20/Dec	17:26	254	100.00	1400
20/Dec	17:26	0	---	0
20/Dec	17:26	254	62.50	500
20/Dec	17:26	254	100.00	800
20/Dec	17:26	117	18.75	150
20/Dec	17:26	0	---	0
20/Dec	17:26	254	100.00	850

17.6 Various Dosing Channel Configurations

- Method 1
- Method 2
- Method 3

17.6.1 METHOD 1

- Dosing Pump control = Calculated according to Nominal Flow Rate
- Dosing pump measurement = Calculated according to Fert. Meter
- Dosing pump type = Venturi or Electric

Inject fertilizer according to nominal capacity of pump/measure from fertilizer meter for verification purposes

Dosing Channel Configuration

No.	Pump	Method	Venturi
1	Electric	Liter/Pulse	Hydraulic
2	Venturi	Time(Lit/h)	Electric
3	Venturi	Time(Lit/h)	999.000

Set nominal pump capacity

No.	Pump	Method	Ratio
1	Electric	Time(Lit/h)	200.000
2	Venturi	Time(Lit/h)	999.000
3	Venturi	Time(Lit/h)	999.000

Set dosing meter ratio V/P of dosing meter, = volume per pulse in liter (L) or gallon (G)

No.	High(%)	Low(%)	U/P(L)
1	50	50	1.000
2	50	50	---
3	50	50	---

Alarm Menu

1. ALARM RESET
 2. HISTORY
3. ALARM DEFINITION
 4. ALARM SETTING
 5. EC/PH ALARM DEFINITION
 6. EC/PH ALARM SETTING

Alarm Definition

Water Fill Up (min)	1
Water Leak (m3)	1.000
Water Leak Period (hh:mm)	00:30
Identify Leak-Subtr. Meter?	NO
Dosing Channel Leak Delay(s)	3
Dosing Channel Leak (Pulse)	10
Dosing Flow Difference (%)	25
Missing Pulses For No Flow	1
Stop System Cons.Flow Alarms	1
# of Irrig. Without Drainage	3
Low Pressure Alarm (bar)	2.5
No. Of Short Circ. To Pause	3

Set alarm when the difference between the nominal dosing flow and the measured dosing flow is ±xx% (default set at recommended 25%)

17.6.2 METHOD 2

- Dosing Pump control = Calculated according to Nominal Flow Rate
- Dosing pump measurement = Calculated according to dosing pump flow rate
- Dosing pump type = Venturi or Electric

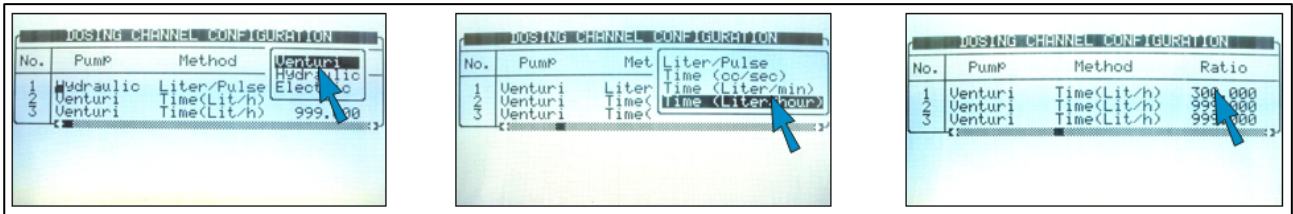

17.6.3 METHOD 3

- Dosing Pump control =According Fert. meter pulses (For quantitative injection only)
- Dosing pump measurement= Fert. Meter
- Dosing pump type= Hydraulic

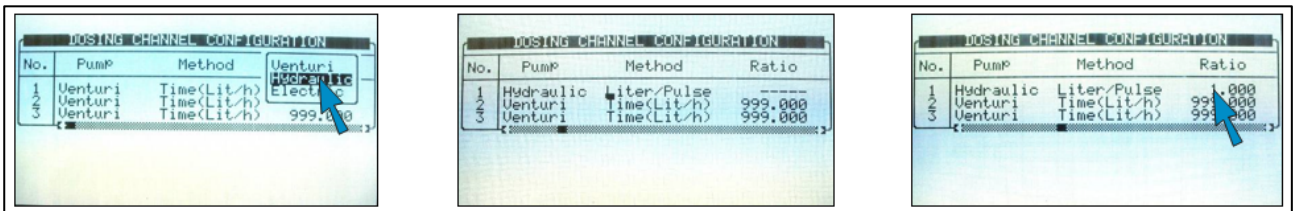

17.7 Dosing Configuration

- EC/pH Control
- EC/pH Control- Alarm Setting

Type of each channel configured by technician during installation process

- EC- channel influenced by EC levels
- ACID- channel to inject acid to reduce pH levels
- PASSIVE- no EC/pH influence
- ALKALI- channel to increase pH levels

17.7.1 EC/PH CONTROL

System will inject +/- depending on EC levels, auto-adjust to meet target levels. Set limits for controller adjustments when levels are too high/low.

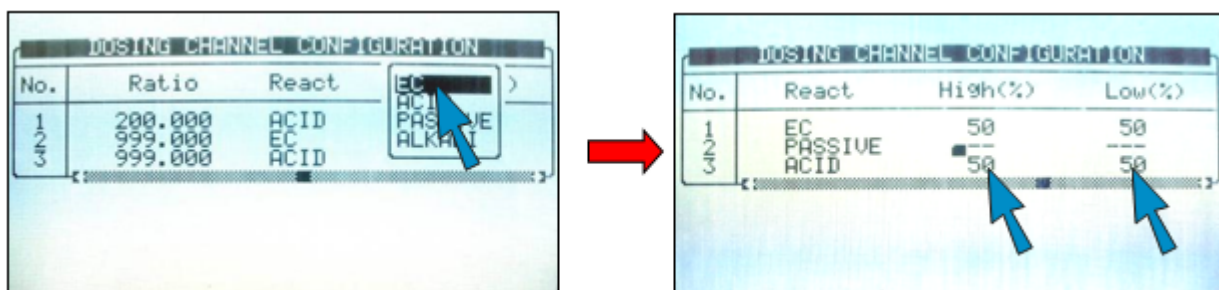

Ex: If dosing channel 1 is set by the grower to inject 10 liter/m³, the controller auto adjust range is 5 to 15 liter/m³ in order to meet the EC level.

17.7.2 EC/pH CONTROL- ALARM SETTING

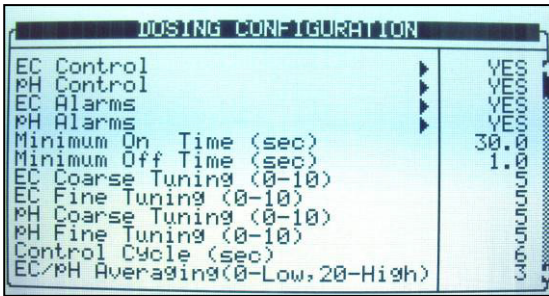

- EC/pH coarse tuning- when way off target, faster/stronger correction
- EC/pH fine tuning- off target is low, slow/light correction
- Control cycle- Delay time from fertilizer/Acid injection point to EC/pH sensors reading
- EC/pH averaging- balanced reading from EC/pH sensors
- Dose boost off delay- time clear water circulated through system after fertigation stops and venturi closes

17.8 Dual EC/pH Sensors

Additional sensors as fail-safe and to verify if difference occurs, alarm will signal.

Install sensors as in section 7.4

CONFIGURATION

4. VALVE FLOW RATE
5. WATER METER
5. DOSING CHANNEL CONFIGURATION
6. DOSING CONFIGURATION
8. EC PRE-CONTROL CONFIGURATION
9. DRAINAGE CONFIGURATION
10. SYSTEM PRESSURE CONFIGURATION
11. RADIATION CONFIGURATION
12. EC/pH CONFIGURATION
13. PRESSURE SENSORS RAN... DEFIN.C

EC/pH CONFIGURATION

Sensor	4 mA	20 mA	Sensor Dif.
EC 1	0	10	
pH 1	0	14	
EC 2	0	10	
pH 2	0	14	
EC P	0	20	

EC Control Sensor ▶ EC 1+EC 2
pH Control Sensor ▶ pH 1+pH 2

Enter sensor difference to set alarm

Sensor	4 mA	20 mA	Sensor Dif.
EC 1	0	10	
pH 1	0	14	
EC 2	0	10	0.50
pH 2	0	14	0.50
EC P	0	20	

EC Control Sensor ▶ EC 1+EC 2
pH Control Sensor ▶ pH 1+pH 2

ALARM

1. ALARM RESET
2. HISTORY
3. ALARM DEFINITION
4. ALARM SETTING
5. EC/pH ALARM DEFINITION
6. EC/pH ALARM SETTING

EC/pH ALARM SETTING

Description	Irrig. Dose	Delay	Alarm	Active
EC High/Fail	STOP	STOP	01:00	YES
EC Low	STOP	STOP	01:00	YES
pH High	STOP	STOP	01:00	YES
pH Low/Fail	STOP	STOP	01:00	YES
EC P-Hi/Fail	STOP	STOP	01:00	YES
EC P-Low	STOP	STOP	01:00	YES
EC Pre- Low	STOP	STOP	01:00	YES
EC Tank Fresh	STOP	STOP	01:00	YES
EC Tank Drain	STOP	STOP	01:00	YES
EC Sen. Dif.	STOP	STOP	01:00	YES
pH Sen. Dif.	STOP	STOP	01:00	YES

EC/pH CONFIGURATION

Sensor	4 mA	20 mA	Sensor Dif.
EC 1	0	10	
pH 1	0	14	
EC 2	0	10	
pH 2	0	14	
EC P	0	20	

EC Control Sensor ▶ EC 2
pH Control Sensor ▶ pH 1+pH 2

Select action and delay-
if 1 sensor fails, sensor 2 activated

At end, if one sensor fails, the technician can set
the system to be controlled by the 2nd sensor

17.9 Advanced System Setup

End day time

Stop time for measuring water and dosing accumulating information from irrigation valves and dosing channels

Max. cooling parallel

Max. misting parallel

Define cooling/misting valve/pump

Cool No.	Pump	Main Valve
1	1	1
2	1	1

Setup

System Setup

Set max. cooling/misting programs working together

NOTE Use only when the system has a limited capacity to operate max # cooling/misting programs simultaneously.

Stop irrigation?

Set to pause irrigation during cooling/misting process, then resume irrigation

Stop Dosing?

Set to pause dosing during filter flushing process, then resume irrigation

Valve transition

Set delay between valves or set to overlap valves in order to create pressure before opening them by pressing +/- key

5 second overlap

5 second delay

IRRIGATION PROGRAM

Default hot key/ History resolution

Change setting of default hot key that will be present for the grower as a default.
Set history resolution-how often system saves information

Weather station

Local - Only one controller network
Master- connected to station, transfers data to slave controller
Slave- more than 1 controller network, not connected to weather station but receive data by communication to the Master
**Each controller must be given I.D. # prior to this setting

Baud rate

Select baud rate of communication:
Lower Port - Controllers and PC
Upper Port - Controller and its expansion boxes/Remote unit (SingleNet)

17.10 Hot Keys And Status Screens

In the Active Irrigation screen, can view filter status of the system by pressing number keys corresponding to each hot

Hot Screen 1- Active Irrigation

ACTIVE IRRIGATION	SET	ACTUAL	LEFT
CYCLE	00:10:00	00:00:09	00:09:52
WATER FLOW	100.000	100.000	
EC	not set	1.5	
pH	not set	5.3	

PROGRAM: MANUAL 14:12:02 IRRIGATION VALUE: 1 14-Mar-07 D DUSING

ALARM

Hot Screen 2- Irrigation Process Status

IRRIGATION PROCESS				
Prog:Un. irr Value: 1 Time: 16:43:49				
	Set	Actual	Flow	Valve
Water	00:10	00:00	0.000	ON
Chan. 1	5.00	0.00	---	OFF
Chan. 2	5.00	0.00	999.000	OFF
Chan. 3	3.00	0.00	999.000	OFF

Hot Screen 3- Program Status

PROGRAM STATUS		
Program: 1	18-Oct-07	16:43:58
Status	Time - Minimum	End 20:00
	Time - Maximum	---
Rad Sum - Measured/Limit		0/0
Clock Starts - Given/Set		---
Starts Due To Rad Sum		---
Starts Due To Max Time		---
Total Cycles Given		---
Last Start		00:03:12
Elapsed Time		---
Next Start		---

Hot Screen 4- Water Flow & EC/pH Status

WATER FLOW		EC/pH			
Status	Prog	Trg.	EC	pH	EC.Pre
Now.	100.000		1.5	5.5	
Act.	0.000				

	Open(%)	Min(%)	Prog(%)	Max(%)
Chan. 1	---	---	---	---
Chan. 2	---	---	---	---
Chan. 3	---	---	---	---

Hot Screen 5- Filter Flushing Status

FILTER FLUSHING STATUS	
Item	Value
Flush Status	OFF
Time To Next Flush	01:02:52
Delta Pressure (Digital)	OFF
Flushing Filter No.	---
Remaining Filters Qty.	0
Delay	00:05
Current Delta Pressure	---
Main Filter Delay	00:00:10

Hot Screen 6- Temp. & Hum. Status

TEMP & HUMIDITY		
No.	Temp.	Humidity
1	23.1	58.0
2	<NONE>	<NONE>
3	<NONE>	<NONE>
4	<NONE>	<NONE>
5	<NONE>	<NONE>
6	<NONE>	<NONE>
7	<NONE>	<NONE>
8	<NONE>	<NONE>
AUG.	23.1	58.0

Hot Screen 7- Weather Station Status

Outside Temperature	<NONE>
Outside Humidity	<NONE>
Wind Direction	<NONE>
Wind Speed	0.0 Km/h
Radiation	<NONE>
Radiation Sum	<NONE>
Rain Status	<NONE>
Rain Flow	<NONE>
Daily Rain	<NONE>

Hot Screen 8- System Pressure Status

SYSTEM PRESSURE	
Sensor	Value
Pressure In	N/A
Pressure Out	N/A

*The Highlighted Sensor Is The System Pressure

17.11 Operation Mode

There are three levels of operation:

- Read Only (restricted): All the parameters and menus are visible, but cannot be modified

- User (partially restricted): Menus 1-6 are fully accessible and can be modified. Menus 7 and 8 can be viewed but not modified
- Technician (unrestricted): All menus are fully accessible (no restrictions)

To change the operation mode, press the Mode key:

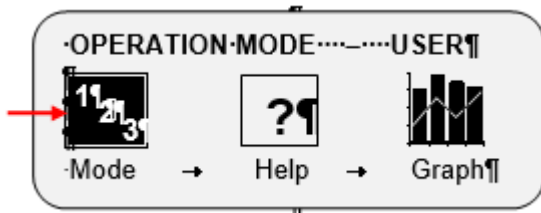

Press ENTER when the “Mode” icon is selected

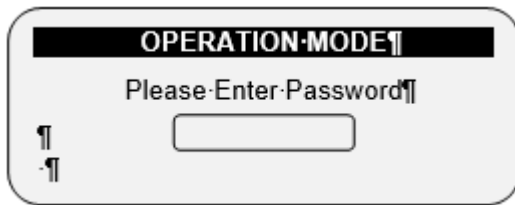

The controller recognizes the operation mode according to the password that is entered:

MODE	PASSWORD
Read Only	0000
User	9785 or 0101
Technician	38845

If an incorrect password is entered, then this screen will appear:

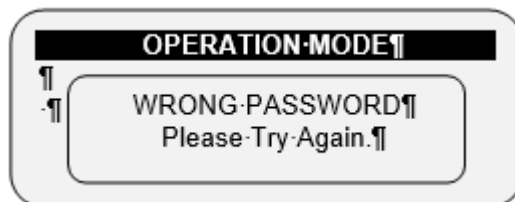

The Operation mode can be configured to automatically return to the “Read-Only” mode after a certain amount of time.

NOTE Refer to System Setup, page 77.

SYSTEM SETUP		
HISTORY		
History Resolution	▶	1 HOUR
WEATHER STATION		
Controller Function	▶	LOCAL
OPERATION MODE		
Automatic return to RO mode	▶	NO
Return period to RO mode	▶	00:10
COMMUNICATION		
Controller Number	▶	1
Lower Port: Protocol	▶	Green Field NET
Lower Port: BaudRate	▶	9600
Upper Port: Protocol	▶	NONE
Upper Port: BaudRate	▶	9600

- In order to perform a cold start or firmware upgrade, the controller must be in the “Technician” mode.
- If there is a power failure, the controller will power up with the last mode that used.

18 Appendix A: Parts List

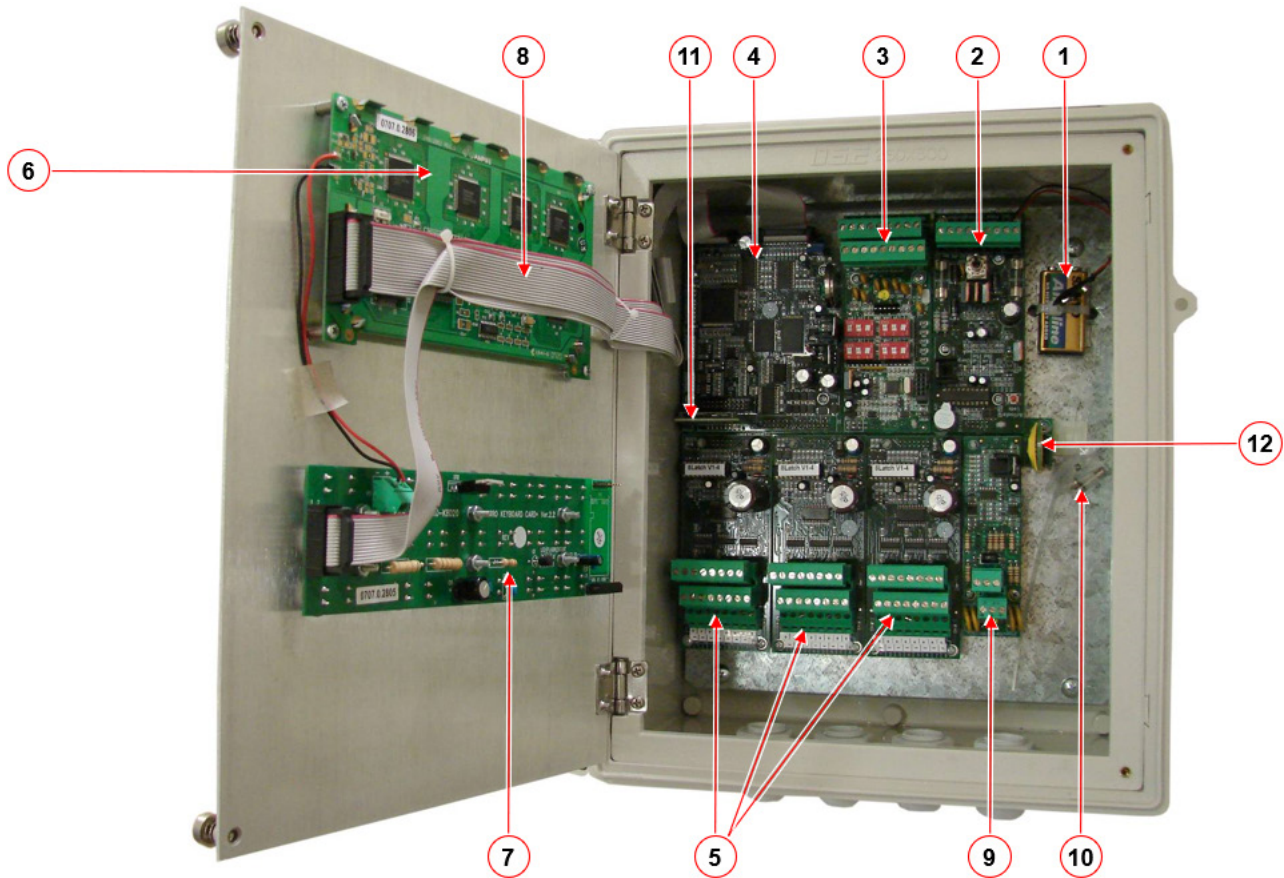

Item #	Description	
1	9V Battery	960-99-00133
2	Green Field DC Power Supply card	960-99-00134
3	Green Field DC Digital & Analog Input card	960-99-00135
4	Green Field DC CPU card	960-99-00136
5	Green Field DC 8 Latch Output card	960-99-00137
6	Green Field DC Display card	960-99-00138
7	Green Field DC Keyboard card	960-99-00139
8	Flat Cable	960-99-00140
9	Green Field DC Communication card	960-99-00141
10	Spare Fuse x2	960-99-00142
11	Green Field DC SD Card	960-99-00143
12	Green Field DC Data Plug	960-99-00144

19 Appendix B: Troubleshooting

- Power Failure
- "No Flow" Alarm
- "Sensor Fail" Alarm
- Display Backlight Failure

19.1 Power Failure

ENSURE Switch is in the ON position.

Option B - Replace Battery
If controller turns on and off:

SELECT ⇒ "5. Test"
⇒ "7. Power & Communication"

VERIFY Solar Panel ≈ 13.0 Volts
Main Battery ≈ 12.5 Volts
Main Battery Status = FULL

Option A - Replace Fuse
If controller still is not working then turn switch OFF and:

REPLACE Fuse x2

IF CONTROLLER STILL IS NOT WORKING THEN:

FINAL SOLUTION
REPLACE Battery

19.2 "No Flow" Alarm

If a "No Flow" alarm appears go through the following steps to identify the problem.

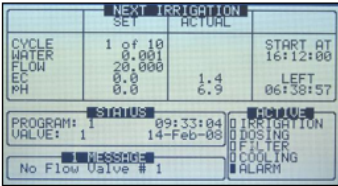

Option A – Relay Card Malfunction

DESCRIPTION	LOC.	EXP1	EXP2	EXP3
Analog Input	1	0	-	-
Digital Input	1	1	-	-
Relay Card	1	2	-	-
Exp. Box Version	-	1.03	-	-
Qty. Rem. Output Key	256	-	-	-

ENSURE All RELAY cards installed are present

If one of the RELAY cards is not present, go to *Appendix C - Replacement and Additional Installations*. Follow the steps for replacing the appropriate Relay Latch card.

1

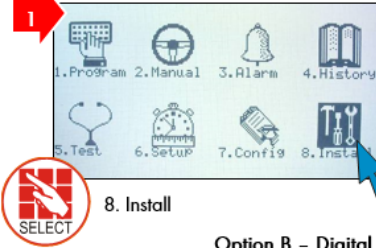

8. Install

Option B – Digital Input Card Malfunction

DESCRIPTION	LOC.	EXP1	EXP2	EXP3
Analog Input	1	0	-	-
Digital Input	1	1	-	-
Relay Card	1	2	-	-
Exp. Box Version	-	1.03	-	-
Qty. Rem. Output Key	256	-	-	-

ENSURE D. In (Digital Input Card) is present

If Digital Input card is not present, go to *Appendix C - Replacement and Additional Installations*. Follow the steps for replacing the Digital Input card.

2



6. Hardware Checklist

19.3 "Sensor Fail" Alarm

If a "Sensor Fail" alarm appears go through the following steps to identify the problem.

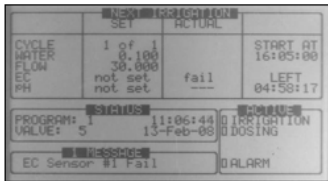

Option A – Digital Input Card Malfunction

DESCRIPTION	LOC.	EXP1	EXP2	EXP3
Analog Input	1	0	-	-
Digital Input	1	1	-	-
Relay Card	1	2	-	-
Exp. Box Version	-	1.03	-	-
Qty. Rem. Output Key	256	-	-	-

ENSURE D. In (Digital Input Card) is present

If Digital Input card is not present, go to *Appendix C - Replacement and Additional Installations*. Follow the steps for replacing the Digital Input card.

1

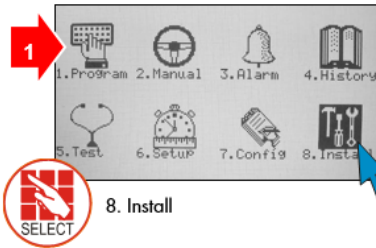

8. Install

Option B – Dip Switches Position Incorrect

VERIFY Dip Switches are correctly arranged according to *Appendix D - Sensor Installation and Definition*

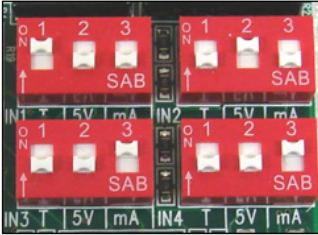

2



6. Hardware Checklist

Option C – Sensor Malfunction

If Dip switches are correctly positioned, go to section *8.3 Analog Input Test* and make sure controller receives proper sensor readings.

19.4 Display Backlight Failure

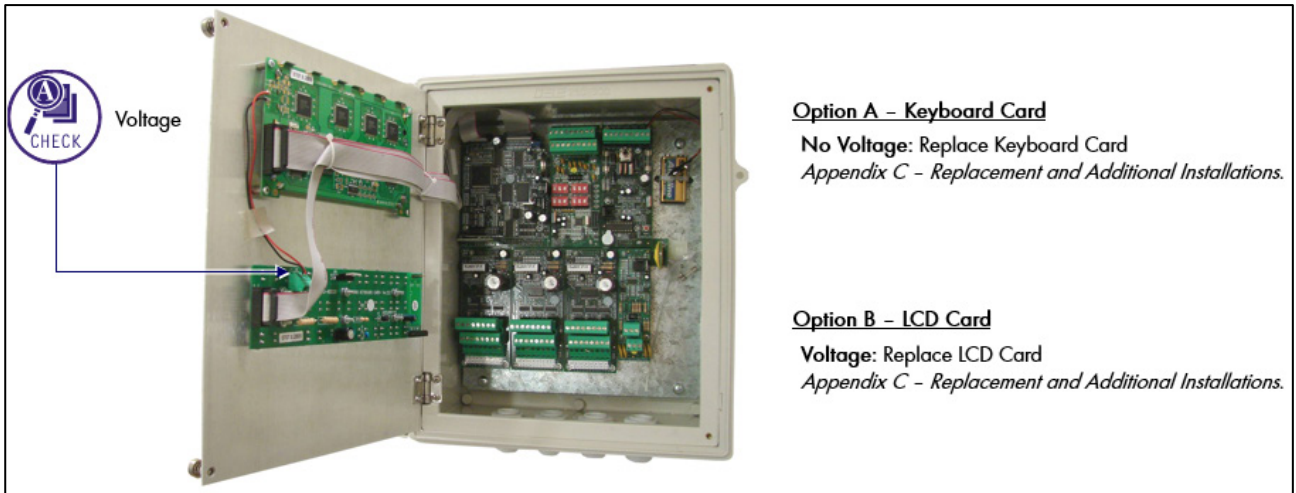

20 Appendix C: Replacements And Additional Installations

- Install 8 Latch Output Card
- Remove a Card
- LCD & Keyboard Replacement

20.1 Install 8 Latch Output Card

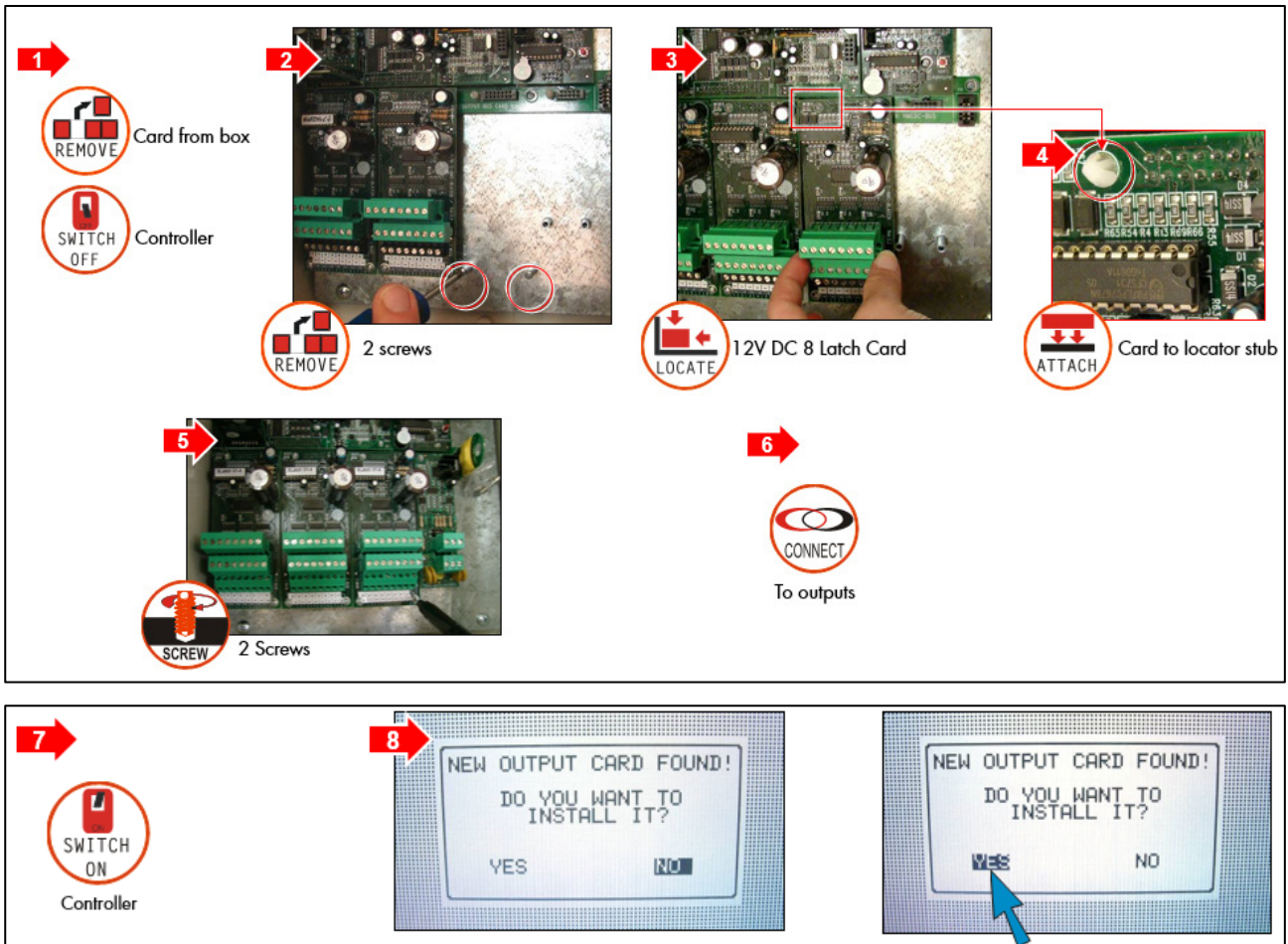

20.2 Remove a Card

Same For All Cards

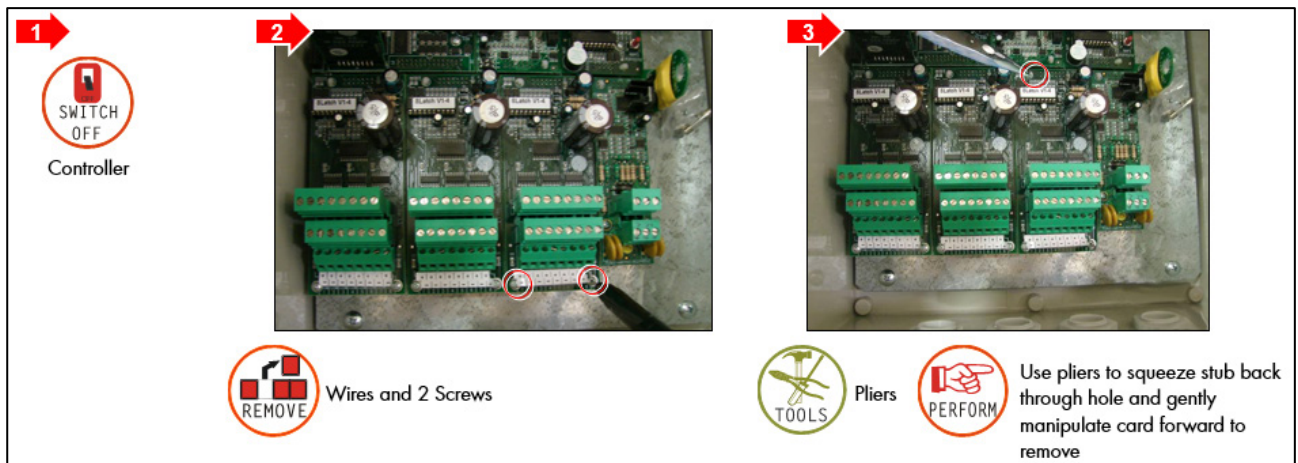

20.3 LCD & Keyboard Replacement

If LCD or keyboards are no longer in working condition first recognize if your LCD or keyboard is an OLD or NEW version.

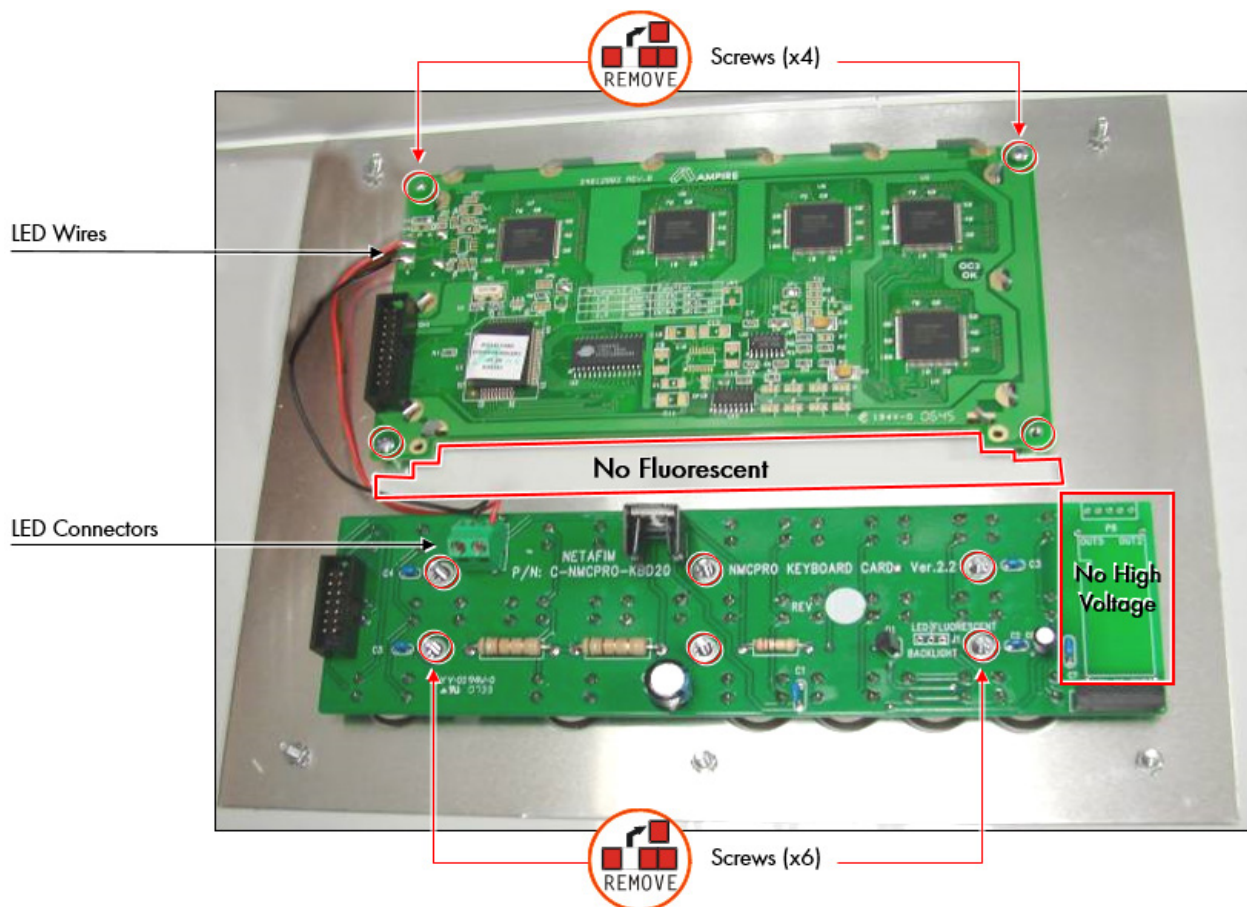

21 Appendix D: Sensor Installation And Definition

- EC: pH Sensor Connection
- Outside Temp/Hum Sensor Connection
- Sensor Definition
- Pyranometer Connection
- Radiation Sensor Definition
- Radiation Sensor Configuration
- Pressure Transducer Connection
- Analog Pressure Sensor Definition

21.1 EC: pH Sensor Connection

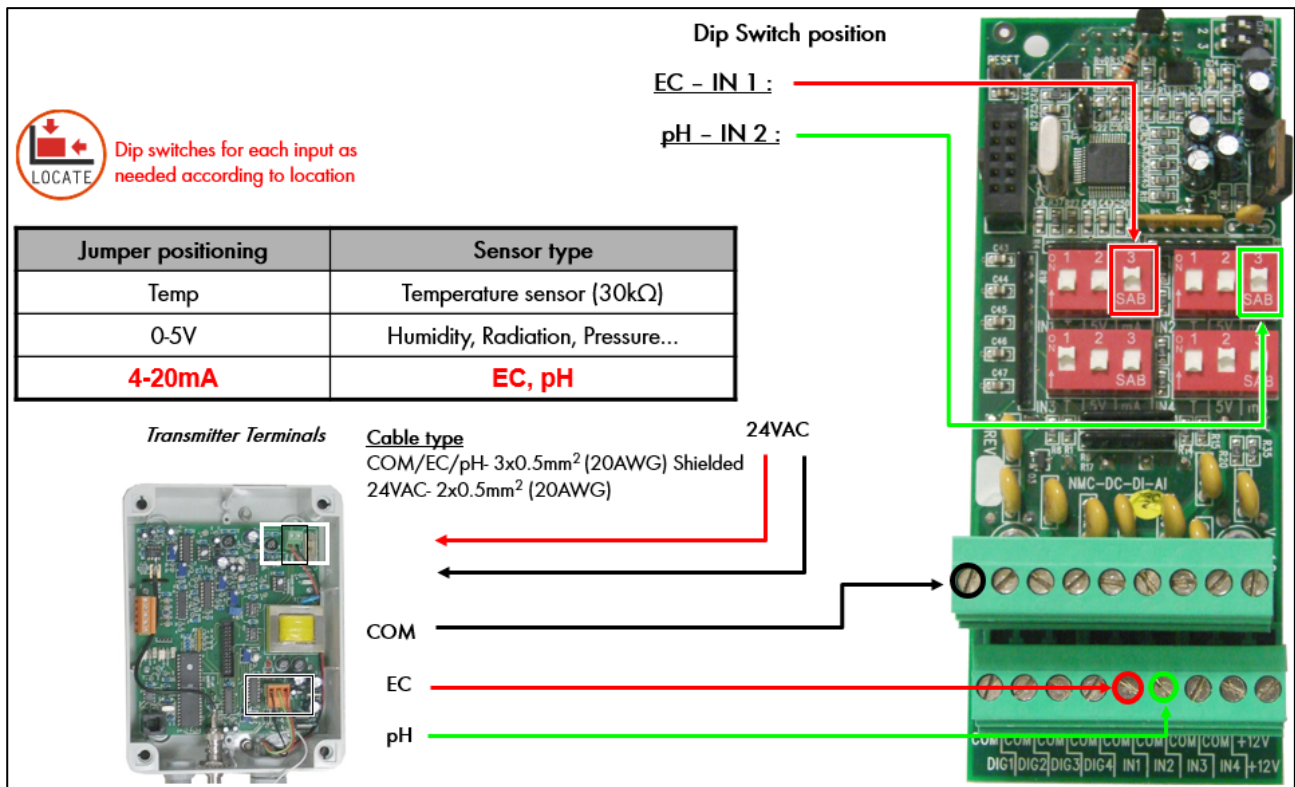

21.2 Outside Temp/Hum Sensor Connection

Outside Temp – IN 3 :
 Outside Hum – IN 4 :

Dip Switch position	Sensor type
Temp	Temperature sensor (30kΩ)
0-5V	Humidity
4-20mA	EC, pH, CO2...



Cable type
 4x0.5mm² (20AWG)

Sensor Wires
 Temp&Hum sensor: Black - COM
 Hum sensor: White - Input
 Temp sensor: Red - Input
 Hum sensor: Red - +12VDC

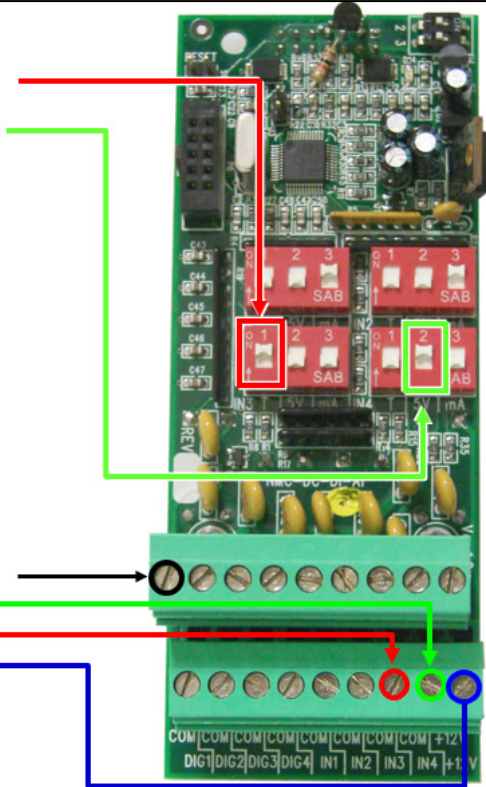

21.3 Sensor Definition

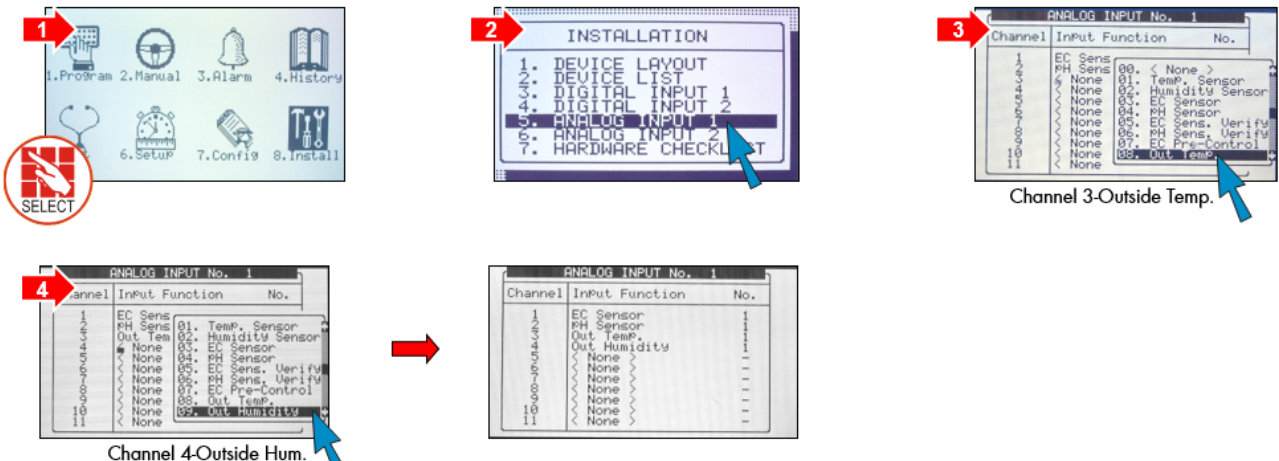

1 1. Program 2. Manual 3. Alarm 4. History
 5. Staircase 6. Setup 7. Config 8. Install
 SELECT

2 INSTALLATION
 1. DEVICE LAYOUT
 2. DEVICE LIST
 3. DIGITAL INPUT 1
 4. DIGITAL INPUT 2
 5. ANALOG INPUT 1
 6. ANALOG INPUT 2
 7. HARDWARE CHECKLIST

3 ANALOG INPUT No. 1
 Channel Input Function No.
 1 EC Sens 00. < None >
 2 PH Sens 01. Temp. Sensor
 3 None 02. Humidity Sensor
 4 None 03. EC Sensor
 5 None 04. pH Sensor
 6 None 05. EC Sens. Verify
 7 None 06. PH Sens. Verify
 8 None 07. EC Prg-Control
 9 None 08. Out Temp.
 10 None
 11 None

Channel 3-Outside Temp.

4 ANALOG INPUT No. 1
 Channel Input Function No.
 1 EC Sens 00. < None >
 2 PH Sens 01. Temp. Sensor
 3 None 02. Humidity Sensor
 4 None 03. EC Sensor
 5 None 04. pH Sensor
 6 None 05. EC Sens. Verify
 7 None 06. PH Sens. Verify
 8 None 07. EC Prg-Control
 9 None 08. Out Temp.
 10 None
 11 None

Channel 4-Outside Hum.

21.4 Pyranometer Connection

Dip Switch position

Pyranometer – IN 4:

Dip Switch position	Sensor type
Temp	Temperature sensor (30kΩ)
0-5V	Radiation
4-20mA	EC, pH, CO2...

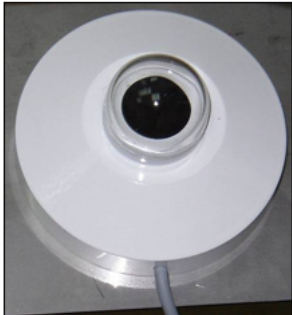

Cable type
3x0.5mm² (20AWG)
Shielded

Sensor Wires
Green - COM
White - Input
Brown +12VDC

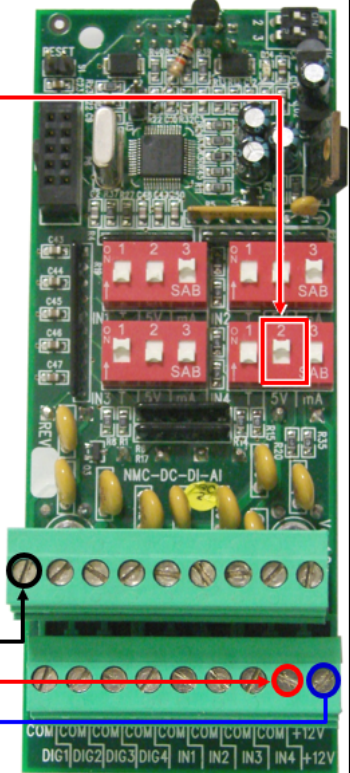

21.5 Radiation Sensor Definition

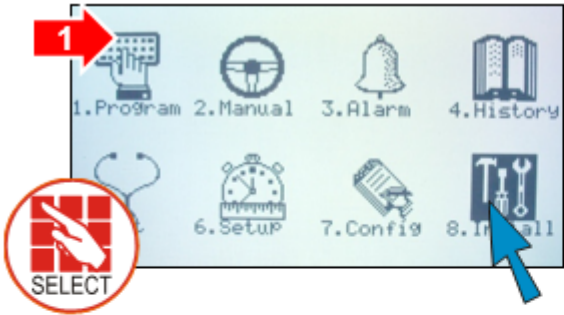

1. Program 2. Manual 3. Alarm 4. History
6. Setup 7. Config 8. Install

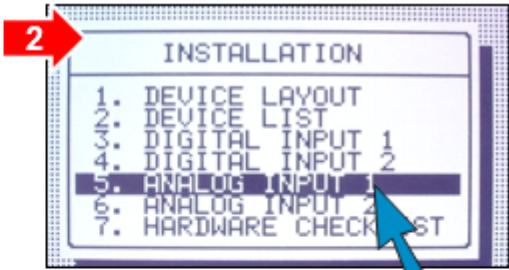

1. DEVICE LAYOUT
2. DEVICE LIST
3. DIGITAL INPUT 1
4. DIGITAL INPUT 2
5. ANALOG INPUT 1
6. ANALOG INPUT 2
7. HARDWARE CHECK LIST

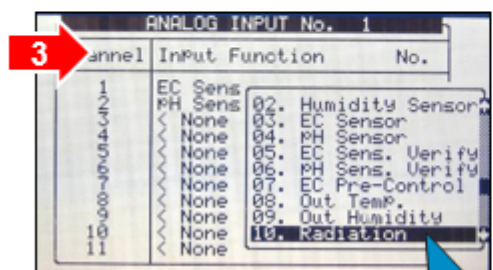

Channel	InPut Function	No.
1	EC Sens	
2	pH Sens	
3	< None >	
4	< None >	
5	< None >	
6	< None >	
7	< None >	
8	< None >	
9	< None >	
10	< None >	
11	< None >	

Channel 4-Radiation

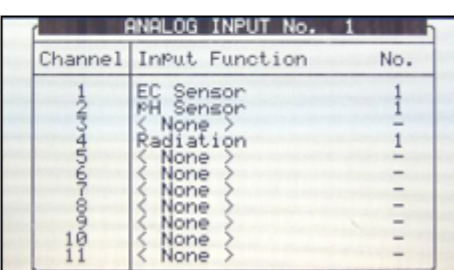

Channel	InPut Function	No.
1	EC Sensor	1
2	pH Sensor	1
3	< None >	
4	Radiation	1
5	< None >	
6	< None >	
7	< None >	
8	< None >	
9	< None >	
10	< None >	
11	< None >	

21.6 Radiation Sensor Configuration

1 Main menu: 1. Program 2. Manual 3. Alarm 4. History 5. Test 6. Setup 7. Config 8. Install

2 CONFIGURATION menu: 3. VALVE CONFIGURATION 4. VALVE FLOW RATE 5. WATER METER 6. DOSING CHANNEL CONFIGURATION 7. DOSING CONFIGURATION 8. EC PRE-CONTROL CONFIGURATION 9. DRAINAGE CONFIGURATION 10. SYSTEM PRESSURE CONFIGURATION 11. RADIATION CONFIGURATION 12. EC/pH CONFIGURATION

3 RADIATION SENSOR CONFIGURATION: Radiation Sensor Type ▶ NETAFIM

4 MENU: In order to use the radiation sensor, You must define a factor larger than zero!

5 MENU

6 Main menu: 1. Program 2. Manual 3. Alarm 4. History 5. Test 6. Setup 7. Config 8. Install

7 SETUP menu: 1. TIME & DATE 2. SYSTEM SETUP 3. TEMPERATURE CALIBRATION 4. HUMIDITY CALIBRATION 5. EC/pH CALIBRATION 6. PRESSURE CALIBRATION 7. RADIATION CALIBRATION 8. SENSOR LOGGING 9. WRITE TO DATA PLUG 10. READ FROM DATA PLUG

8 WEATHER STATION CALIBRATION

	Value	Factor
Temperature	2.2	0.0
Humidity	100.0	0.0
Wind Direction	<NONE>	--
Radiation F.	<FAIL>	2.17
Rad. Offset	<FAIL>	0.00

Press (<-) Arrows to Increase/Decrease
Enter Speeds Up Radiation Factor

ATTENTION Define Radiation Factor according to value on sensor milivolt/watt/m². To Increase/Decrease faster, use arrows while holding down ENTER

9 WEATHER STATION CALIBRATION

	Value	Factor
Temperature	2.2	0.0
Humidity	100.0	0.0
Wind Direction	<NONE>	--
Radiation F.	<FAIL>	2.17
Rad. Offset	<FAIL>	17.00

Press (<-) Arrows to Increase/Decrease
Enter Speeds Up Radiation Factor

ATTENTION Set Radiation Offset to ≥ 17.00 for after sunset when there is no radiation

10 MENU

11 Save Changes? YES NO

21.7 Pressure Transducer Connection

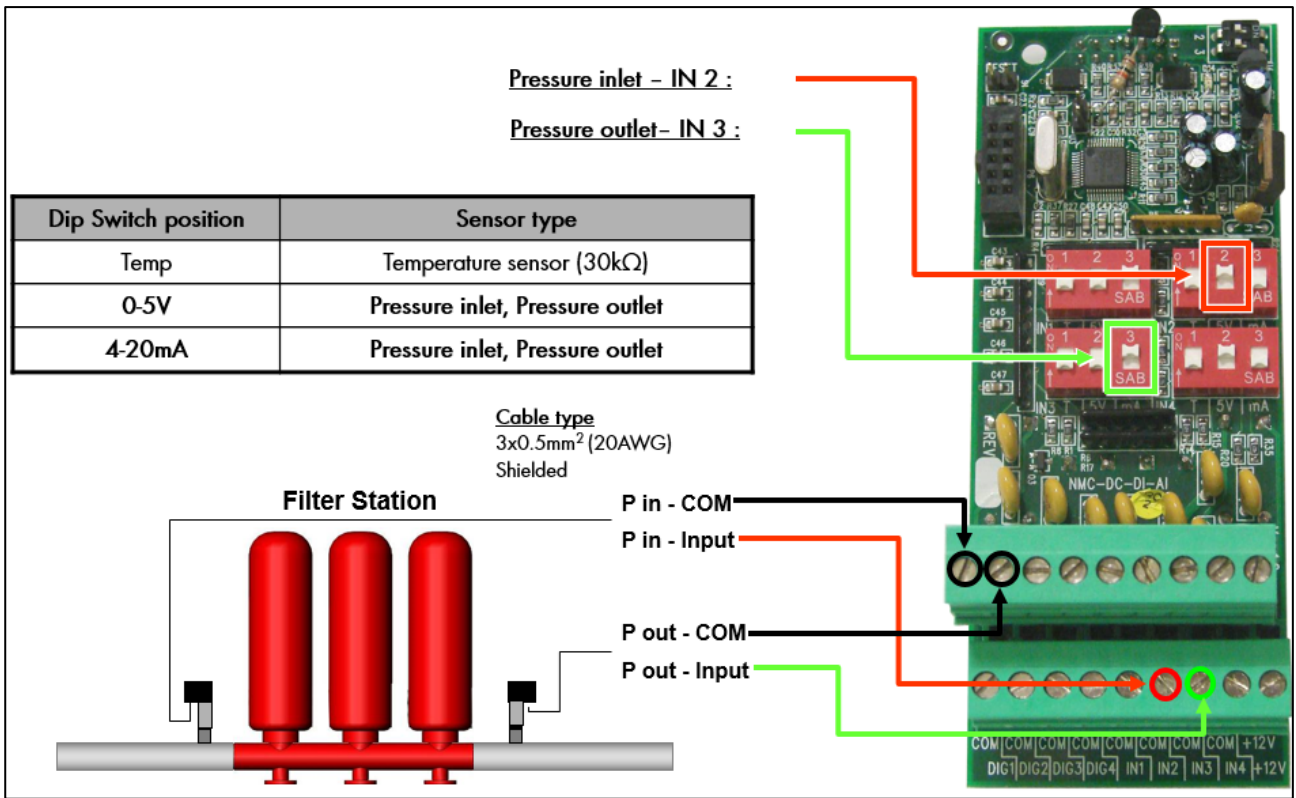

21.8 Analog Pressure Sensor Definition

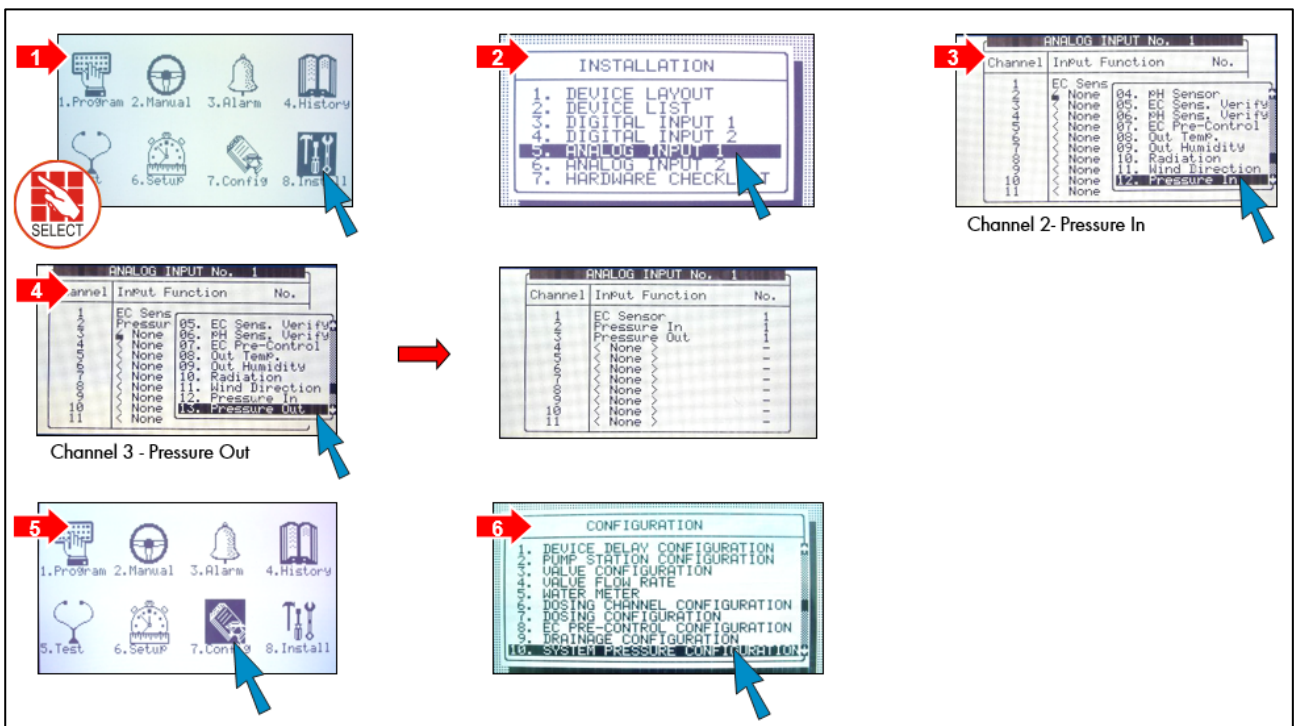

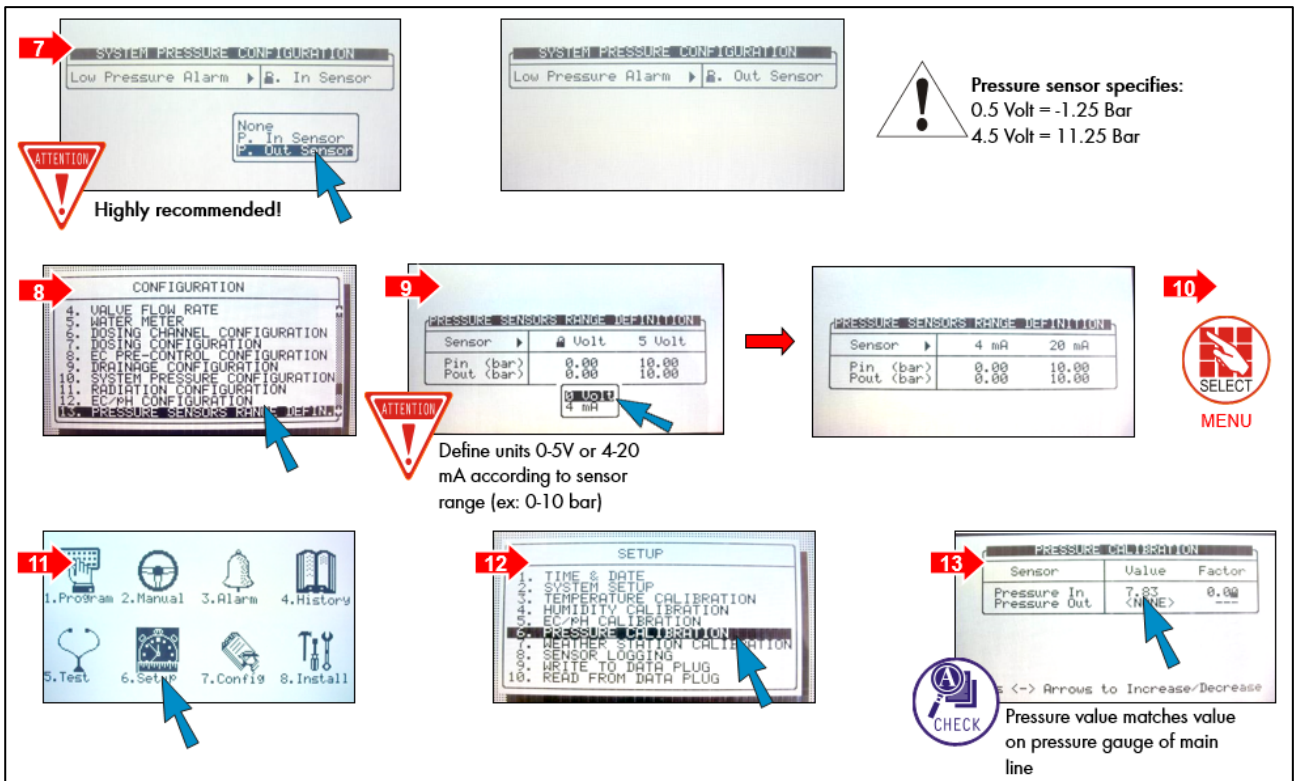

21.9 Sensor and Cable Specifications

Sensor Type	Measured Values	Accuracy	Input Range	Maximum Cable Length	Cable Type
Temperature: RTS-s	-20°C to 50°C/ -4°F to 122°F	0.3°C	30kOhm	500 meter (1640 feet)	2x0.5mm ² (20 AWG)
EC	0 to 10mS (old transmitters used 20mS)	0.05 to 0.1mS	4: 20mA	---	3x0.5mm ² (20 AWG) Shielded
pH	0 - 14	0.1	4: 20mA	---	
RH: RHS-10	0: 100%	±2% (10%-90% RH), ±3.5% (90%-100% RH)	0: 3 VDC	300 meter (985 feet)	3x0.5mm ² (20 AWG)
Pyranometer-	300-2800nanometer (Up to 1500W/m ²)	±5%	0: 5VDC	---	3x0.5mm ² (20AWG) Shielded

Sensor Type	Measured Values	Accuracy	Input Range	Maximum Cable Length	Cable Type
Wind Speed	4-280 km/hr (2-175 mph)	±5%	Pulse output (Wind Cups & Magnetic Switch)	100 meter (330 feet)	4x0.5mm ² (20 AWG)
Pressure	Up to 10bar (145 PSI)	---	0: 5 VDC	---	3x0.5mm ² (20AWG) Shielded
Rain Collector	"Rain amount (mm or inch) Collection area: 200 cm ² (31 inch ²) Resolution: 0.254mm (0.01")"	"±2%, Rainfall count between 0.2-50mm/hr (0.01-2"/hr)±3%, Rainfall count between 50-150mm/hr (2-4"/hr)"	Dry contact (tipping bucket)	100 meter (330 feet)	---
Rain Detector	Rain, No Rain	0.2mm/hr	"Dry contact/0-5VDC"		

22 Appendix E: Technical Specifications

- Technical Specifications
- Controller Components
- Power Supply Fuse Protection
- Outputs
- Common Analog Sensor Specifications

22.1 Technical Specifications

Housing	Plastic housing with a screw on lid	IP 65
	Dimensions (LxWxH)	30x40x18 cm (11.81x15.75x7.08 inch)
	Weight	6.0 kg 13.2 lbs
Ambient Conditions	Operating temperature range	-10 to +50 ⁰ Celsius (14 to 122 ⁰ Fahrenheit)
	Storage temperature range	-10 to +70 ⁰ Celsius (14 to 158 ⁰ Fahrenheit)
Approvals	The 115/230VAC has Safety CE approval	EN61010-1
	EMC approvals CE and FCC	EN55011 Group1 Class A EN61000-3-3; EN61000-6-2; CISPR 11 GROUP 1 CLASS A FCC Part 15 Subpart B

22.2 Controller Components

- Keyboard & Display
- CPU
- Power Supply

22.2.1 KEYBOARD & DISPLAY

- Graphical LCD Display
- Back light
- 5.5"

- Tactile feel Keyboard



22.2.2 CPU

- 32bit CPU
- 8Mb Flash memory
- Settings backup & software upgrade through SD memory card

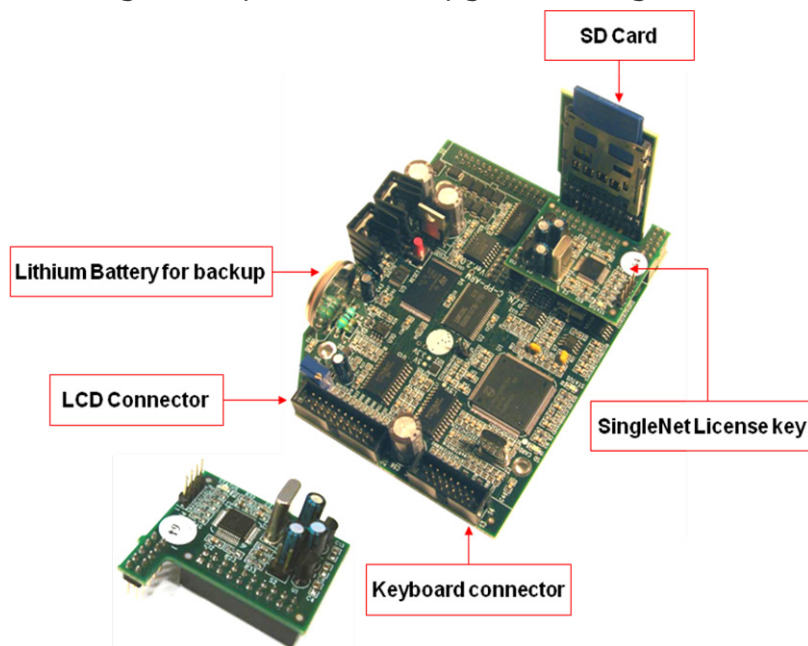

SingleNet License Key

- Communication protocol with SingleNet interface

22.2.3 POWER SUPPLY

- DC Power Supply
 - 12V DC
 - Power Consumption
 - Display ON - Operating comm. Card (485): 180 mA
 - Display OFF - Operating comm. Card (485): 120 mA
 - Display ON - Modem RCLP GSM -200-250 mA depends on state (receiving / broadcasting)
- Protection

- Tubular glass fuse
- Buzzer
 - Sounds when Back Up Battery is connected
- LEDs (Main Battery Status)
 - Low Battery
 - Full Battery
 - Charge
- Jumper
 - Always needed for charging Main Battery

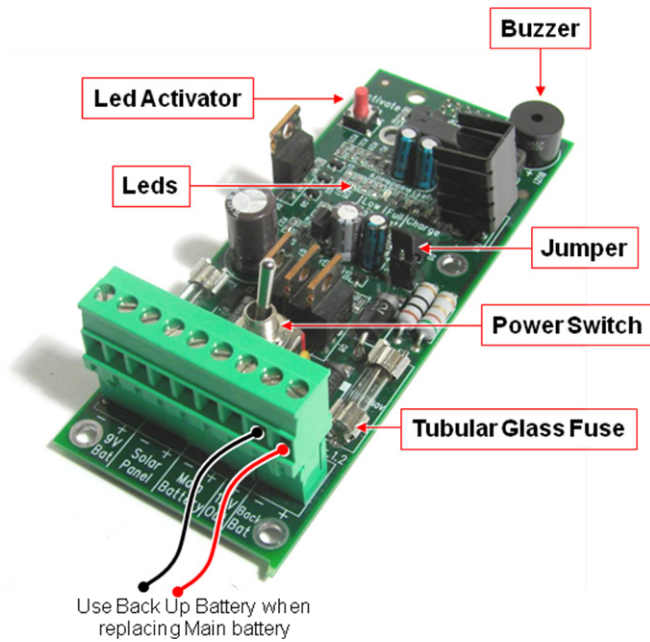

22.3 Power Supply Fuse Protection

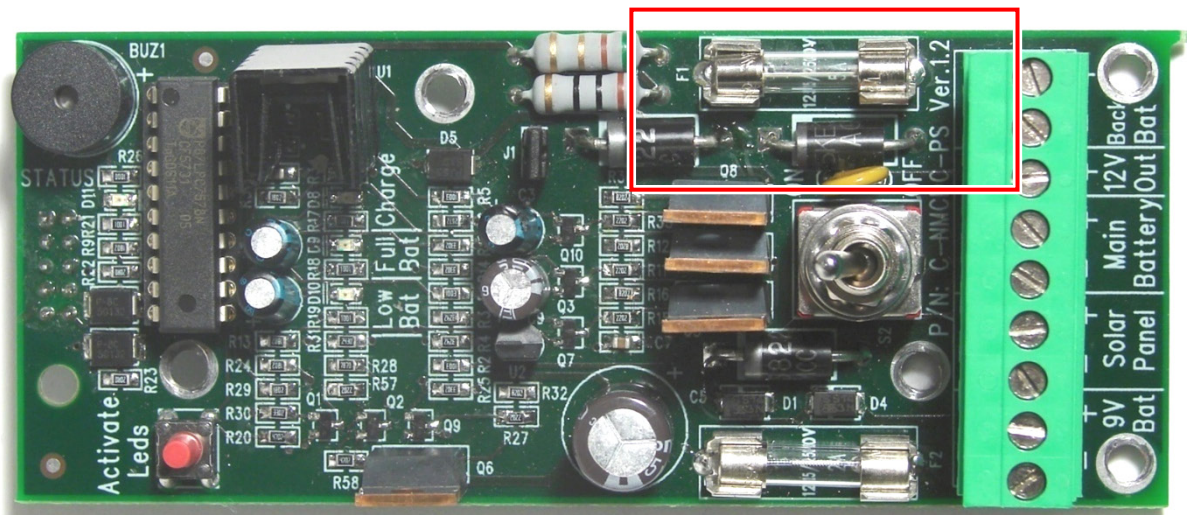

Location	Designation	Type	Style	Rating	Reaction Time	Dimensions
Power Supply, Solar Battery	F1	Tubular Glass	M205	5.0 Amp	Slow Blow (T)	20mm x 5mm
Power Supply, Main Battery	F2	Tubular Glass	M205	2.0 Amp	Slow Blow (T)	20mm x 5mm

22.4 Outputs

- 12V DC Latch Output Card
- Digital & Analog Input Card

22.4.1 12V DC LATCH OUTPUT CARD

- 8 Outputs
- Single output changing duration = 0.015 sec. 0.04 sec. 0.09 sec.

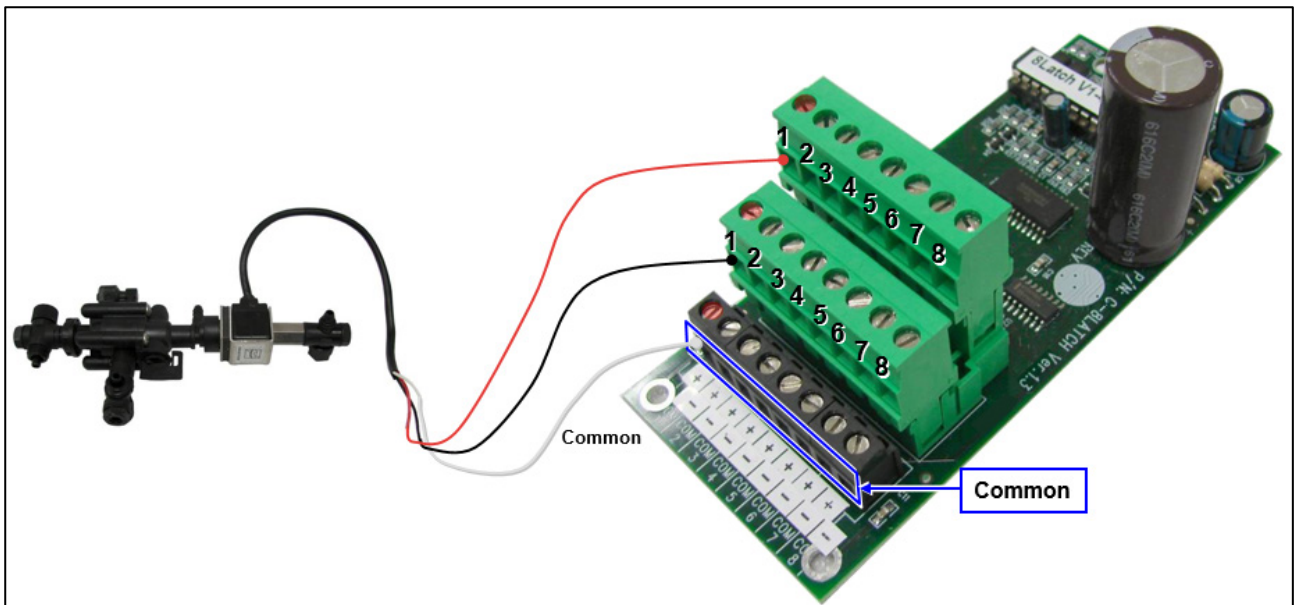

22.4.2 DIGITAL & ANALOG INPUT CARD

- 4 x D.I. Inputs
- 4 x A.I. Inputs
- Maximum pulse rate 50pulse/sec (<50 Hz)
- Inputs 1: 4: Temperature (NTC 30K Ω), 0-5VDC (Radiation, Relative Humidity, Pressure...), 4-20mA (EC, pH, Pressure...)

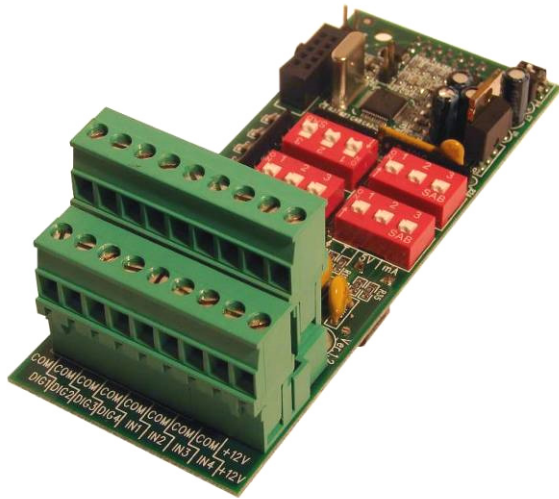

22.5 Common Analog Sensor Specifications

Sensor	Measured Values	Input Range
Temperature: RTS-s	-20°C to 50°C/ -4°F to 122°F	30kOhm
EC	0 to 10mS (old transmitters used 20mS)	4: 20mA
pH	0 - 14	4: 20mA
RH: RHS-10	0: 100%	0: 3 VDC
Pressure	Up to 10bar (145 PSI)	0: 5 VDC
Radiation	0: 1800 w/m ²	0: 5 VDC

23 Warranty

Warranty and technical assistance

Munters products are designed and built to provide reliable and satisfactory performance but cannot be guaranteed free of faults; although they are reliable products they can develop unforeseeable defects and the user must take this into account and arrange adequate emergency or alarm systems if failure to operate could cause damage to the articles for which the Munters plant was required: if this is not done, the user is fully responsible for the damage which they could suffer.

Munters extends this limited warranty to the first purchaser and guarantees its products to be free from defects originating in manufacture or materials for one year from the date of delivery, provided that suitable transport, storage, installation and maintenance terms are complied with. The warranty does not apply if the products have been repaired without express authorisation from Munters, or repaired in such a way that, in Munters' judgement, their performance and reliability have been impaired, or incorrectly installed, or subjected to improper use. The user accepts total responsibility for incorrect use of the products.

The warranty on products from outside suppliers fitted to Farm Link, (for example Farm Link's antennas, power supplies, cables, etc.) is limited to the conditions stated by the supplier: all claims must be made in writing within eight days of the discovery of the defect and within 12 months of the delivery of the defective product. Munters has thirty days from the date of receipt in which to take action, and has the right to examine the product at the customer's premises or at its own plant (carriage cost to be borne by the customer).

Munters at its sole discretion has the option of replacing or repairing, free of charge, products which it considers defective, and will arrange for their despatch back to the customer carriage paid. In the case of faulty parts of small commercial value which are widely available (such as bolts, etc.) for urgent despatch, where the cost of carriage would exceed the value of the parts, Munters may authorise the customer exclusively to purchase the replacement parts locally; Munters will reimburse the value of the product at its cost price.

Munters will not be liable for costs incurred in demounting the defective part, or the time required to travel to site and the associated travel costs. No agent, employee or dealer is authorised to give any further guarantees or to accept any other liability on Munters' behalf in connection with other Munters products, except in writing with the signature of one of the Company's Managers.

WARNING: In the interests of improving the quality of its products and services, Munters reserves the right at any time and without prior notice to alter the specifications in this manual.

The liability of the manufacturer Munters ceases in the event of:

- dismantling the safety devices;
- use of unauthorised materials;

- inadequate maintenance;
- use of non-original spare parts and accessories.

Barring specific contractual terms, the following are directly at the user's expense:

- preparing installation sites;
- providing an electricity supply (including the protective equipotential bonding (PE) conductor, in accordance with CEI EN 60204-1, paragraph 8.2), for correctly connecting the equipment to the mains electricity supply;
- providing ancillary services appropriate to the requirements of the plant on the basis of the information supplied with regard to installation;
- tools and consumables required for fitting and installation;
- lubricants necessary for commissioning and maintenance.

It is mandatory to purchase and use only original spare parts or those recommended by the manufacturer.

Dismantling and assembly must be performed by qualified technicians and according to the manufacturer's instructions.

The use of non-original spare parts or incorrect assembly exonerates the manufacturer from all liability.

Requests for technical assistance and spare parts can be made directly to the nearest [Munters office](#).

