

User Manual

Platinum Touch /Rotem One



Platinum Touch/Rotem One Standard Mode

Climate Controllers

Ag/MIS/UmGb-2636-10/18 Rev 1.9

P/N: 117550



Platinum Touch / Rotem One Standard Mode

User Manual

Revision: N.1.9 of 07.2023

Ag/MIS/UmGb-2636-10/18 Rev 1.1 (MIS)

Product Software: 7.24

This manual for use and maintenance is an integral part of the apparatus together with the attached technical documentation.

This document is destined for the user of the apparatus: it may not be reproduced in whole or in part, committed to computer memory as a file or delivered to third parties without the prior authorization of the assembler of the system.

Munters reserves the right to effect modifications to the apparatus in accordance with technical and legal developments.

Index

<i>chapter</i>		<i>page</i>
1	INTRODUCTION.....	10
1.1	Disclaimer.....	10
1.2	Introduction	10
1.3	Notes	10
2	INTRODUCTION TO THE PLATINUM TOUCH.....	11
2.1	Main Screen.....	11
2.2	Menu Elements.....	12
2.3	Version	12
2.4	Selecting the Mode	13
3	CONTROL MENU.....	14
3.1	Temperature Curve	15
3.1.1	Temperature Curve Main Screen.....	15
3.1.2	Temperature Curve Help Set Definitions.....	16
3.2	Minimum Vent Timer.....	16
3.2.1	How Does Minimum Ventilation Work?.....	17
3.2.2	Setting up Minimum Ventilation.....	18
3.2.3	Ramping Timer Help Set.....	19
3.2.4	Additional Details.....	19
3.3	Timer Settings.....	20
3.4	Introduction to Humidity, Ammonia, and CO2 Treatment.....	20
3.5	Humidity Treatment.....	21
3.5.1	Humidity Treatment Main Screen.....	21
3.5.2	Humidity Treatment Help Set Definitions.....	22
3.6	CO2 Treatment.....	22
3.6.1	CO2 Main Screen	22
3.6.2	CO2 Treatment Help Set Definitions.....	23
3.7	Static Pressure.....	23
3.7.1	Static Pressure Method	23
3.7.1.1	Attic Static Pressure.....	24
3.7.1.2	Tunnel Ventilation Static Pressure.....	25
3.7.2	Disabling the Static Pressure Sensor.....	25
3.7.3	Static Pressure Help Set Definitions.....	25
3.8	Cool Pad.....	26
3.8.1	Cool Pad (Standard), Version 7.21 and Below.....	26

3.8.1.1	Cool Pad, Main Screen	26
3.8.1.2	Cool Pad Help Set Definitions	27
3.8.2	Cool Pad (Ramping), Version 7.22 and Above	28
3.8.2.1	Cool Pad Main Screen	28
3.8.2.2	Cool Pad Help Set Definitions	30
3.9	Foggers	31
3.9.1	Foggers Main Screen	31
3.9.2	Foggers Help Set Definitions	32
3.10	Water & Feed	32
3.10.1	Water and Feed Main Screen	32
3.10.2	Water and Feed Help Set Definitions	33
3.11	Light	35
3.11.1	Light Main Screen	35
3.11.2	Light Help Set Definitions	36
3.11.3	Light Measurement Control	37
3.12	Extra Systems	39
3.13	Control Mode	39
3.13.1	Control Mode Main Screen	40
3.13.2	Catching Mode	40
3.14	System Parameters	41
3.15	Ammonia Treatment	42
3.15.1	Ammonia Treatment Main Screen	42
3.15.2	Ammonia Treatment Help Set Definitions	42
3.16	Feed Scale Program	43
3.16.1	Feed Scale Help Set Definitions	44
3.16.2	Operating Mode	45
3.16.3	Feed Scale Hot Screen	45
3.16.4	Feed Scale Functionality in Two Houses	46
3.17	Light Dimmers	49
3.18	Water Dosing	51
3.18.1	Water Dosing Main Screen	51
3.18.2	Water Dosing Help Set Definitions	52
4	MANAGEMENT MENU	53
4.1	Bird Inventory	54
4.2	Feed Inventory	54
4.2.1	Feed Inventory Main Screen	54
4.2.2	Feed Inventory Help Set Definitions	55
4.3	Growth Day and Flock	55
4.4	Alarm Settings	56
4.4.1	Alarm Setting Help Set Definitions	58
4.4.2	Prioritizing Alarms	61

4.5	Alarm Reset	61
4.6	Fail Safe Settings.....	62
4.7	Password.....	62
4.8	Feeders & Drinkers.....	63
4.8.1	Feeders & Drinkers Main Screen.....	63
4.8.2	Feeders & Drinkers Help Set Definitions	63
4.9	Nipple Flushing.....	64
4.9.1	Scheduling the Flush.....	65
4.9.2	Flushing Order.....	65
4.9.3	Nipple Flushing by Temperature	65
4.10	Water on Demand	66
4.10.1	Relay Control	67
4.10.2	Sensor Control.....	67
4.10.3	Water on Demand Help Set Definitions	68
4.11	Current Sense	68
4.12	RDT-5	68
4.12.1	Configuring the RDT-5	68
4.12.2	RDT-5 / Temperature Curve Set Definitions	70
4.12.3	RDT-5 Digital Alarm.....	71
4.12.4	Saving and Loading RDT-5 Tables	71
4.12.5	RDT-5, Version 7.22	71
4.13	Switches and Relays.....	72
5	HISTORY MENU	73
5.1	Temperature History	74
5.2	Humidity History.....	74
5.3	CO2 History.....	75
5.4	Bird Weight History.....	75
5.4.1	Bird Weight History, Version 7.18 and Below	75
5.4.2	History, Version 7.19.....	76
5.5	Feed Conversion.....	77
5.6	Water Consumption History.....	77
5.7	Feed Consumption History	78
5.8	Mortality History.....	79
5.9	Heaters History	80
5.10	Radiant Heaters History	80
5.11	Variable Heaters History	81
5.12	Alarms History.....	81
5.13	Events Log History	81
5.14	Power Consumption.....	82
5.15	History View.....	83
5.16	Ammonia History.....	84

5.17	Dosing History	84
6	SYSTEM MENU.....	85
6.1	Scales Testing.....	86
6.2	Hardware Checklist	86
6.3	Setup	87
6.3.1	Setup Main Screen	87
6.3.2	Static Pressure Unit Definition.....	87
6.4	Time & Date.....	88
6.5	Variable Speed Fan Setting	88
6.5.1	Variable Speed Main Screen	88
6.5.2	Variable Speed Fan Help Set Definitions.....	89
6.6	Relay Layout	90
6.6.1	Relay Outlet Main Screen	90
6.6.2	Output Function List	90
6.7	Sensors.....	92
6.7.1	Analog Sensors	92
6.7.2	Digital Sensors.....	93
6.8	Analog Output.....	94
6.8.1	Analog Output Main Screen	94
6.8.2	Analog Output Settings.....	94
6.9	Temperature Definition.....	95
6.10	Temp & Timer Setting.....	96
6.10.1	Temp & Timer Main Screen.....	96
6.10.2	Temp & Timer Settings Help Set.....	97
6.11	Vent Curtain Setup.....	97
6.11.1	Using Time to Calibrate.....	98
6.11.2	Using a Potentiometer to Calibrate	98
6.11.3	Stop Fans.....	99
6.11.4	Vent/Curtain Help Set Definitions	100
6.12	House Dimensions.....	100
6.13	Fan Air Capacity	101
6.14	Setting up a Bird Weight Curve - Summary.....	102
6.15	Non-Gender Based Weighing	102
6.15.1	Scale Layout.....	102
6.15.1.1	Scale Layout Main Screen.....	102
6.15.1.2	Scale Layout Set Definitions.....	103
6.15.2	Bird Scale Setting	103
6.15.2.1	Bird Scale Setting Screen.....	104
6.15.2.2	Bird Scale Setting Set Definitions	104
6.15.3	Bird Weight.....	105
6.15.3.1	Bird Weight Main Screen	105

6.15.3.2	Bird Weight Help Set Definitions	106
6.16	Gender Based Weighing	106
6.16.1	Auto or Auto Turkey Curve	108
6.16.2	Customized/Industrial Standard Curves.....	108
6.17	Silo / Auger Layout	109
6.18	Communication	110
6.19	Scale Layout.....	110
7	APPENDIX A: OUTPUT DATA	111
8	APPENDIX B: NATURAL VENTILATION	114
8.1	Natural Ventilation Setup.....	114
8.2	Theory of Operation	117
8.2.1	Transition to or from Natural Ventilation	117
8.2.2	Curtain Movement	118
8.2.3	Toggle Switches.....	118
9	APPENDIX C: DEVICE SETUP SUMMARY	119
9.1	Stir Fans	119
9.2	Attic Ventilation	119
9.3	Heaters Control	119
10	APPENDIX D: KEYBOARD FUNCTIONS.....	121
10.1	Service Menu.....	121
10.1.1	Temperature Calibration.....	122
10.1.2	Humidity Calibration	122
10.1.3	CO2 Sensor Calibration	123
10.1.4	Static Pressure Calibration.....	123
10.1.5	Light Sensor Calibration	124
10.1.6	Feed Calibration.....	125
10.1.7	Water Calibration	125
10.1.8	Ventilation Potentiometer Calibration.....	125
10.1.9	Nipple Flushing	126
10.1.9.1	Nipple Flushing Help Set Definitions	127
10.1.10	Feeders & Drinkers	127
10.1.10.1	Feeders & Drinkers Help Set Definitions	127
10.1.11	Save Settings.....	128
10.1.12	Load Settings	128
10.1.13	Load Settings Report	129
10.1.14	Current Sense Relay Calibration	129
10.1.15	Wind Direction Calibration.....	130
10.1.16	WOD Calibration.....	131
10.1.16.1	WOD Calibration Help Set Definitions.....	131
10.1.17	Ammonia Calibration	131

10.2	Management Menu: Relay Current	132
10.3	Test Menu.....	133
10.3.1	Alarm	133
10.3.2	Analog Sensors	133
10.3.3	Digital Sensors.....	134
10.3.4	Analog Output.....	134
10.3.5	Static Pressure.....	135
10.3.6	Communication	135
11	APPENDIX E: BREEDER MODE.....	136
11.1	Egg Room Setup.....	136
11.2	Egg Counter	139
11.3	Egg Room Water and Feed.....	140
11.3.1	Setup.....	141
11.3.2	Water and Feed Version 7.24 and Above.....	142
11.4	Egg Belt Runtime	143
11.5	Nest Function.....	144
11.5.1	Nest Function, Version 7.18 and Below.....	144
11.5.2	Nest Function, Version 7.19	145
11.5.2.1	Single Relay	145
11.5.2.2	Dual Relay	146
11.6	Work Room Control.....	147
11.7	Scale Arm.....	148
11.8	Weighing the Birds in Breeder.....	149
11.8.1	Bird Scale Setting	149
11.8.1.1	Measuring Bird Weights, Auto Curve	149
11.8.1.2	Measuring Bird Weights, Customized/Industrial Standard Curve	150
11.8.2	Bird Weight History	152
11.9	Breeder Advanced Feeding	153
11.9.1	Selecting the Mode.....	155
11.9.2	Setup.....	156
11.9.3	Feed Scale Program Help Set Definitions.....	161
11.10	Egg Room History.....	162
12	WARRANTY	163

1 Introduction

1.1 Disclaimer

Munters reserves the right to make alterations to specifications, quantities, dimensions etc. for production or other reasons, subsequent to publication. The information contained herein has been prepared by qualified experts within Munters. While we believe the information is accurate and complete, we make no warranty or representation for any particular purposes. The information is offered in good faith and with the understanding that any use of the units or accessories in breach of the directions and warnings in this document is at the sole discretion and risk of the user.

1.2 Introduction

Congratulations on your excellent choice of purchasing a Platinum Touch/Rotem One!

In order to realize the full benefit from this product it is important that it is installed, commissioned and operated correctly. Before installation or using the controller, this manual should be studied carefully. It is also recommended that it is kept safely for future reference. The manual is intended as a reference for installation, commissioning and day-to-day operation of the Munters Controllers.

1.3 Notes

Date of release: July 2010

Munters cannot guarantee to inform users about the changes or to distribute new manuals to them.

NOTE All rights reserved. No part of this manual may be reproduced in any manner whatsoever without the expressed written permission of Munters. The contents of this manual are subject to change without notice.

2 Introduction to the Platinum Touch

This document describes the Platinum Touch / Rotem One Controller.

- [Main Screen](#)
- [Menu Elements](#)
- [Version](#)
- Selecting the Mode

2.1 Main Screen

Figure 1 shows the Platinum Touch / Rotem One Main Screen.

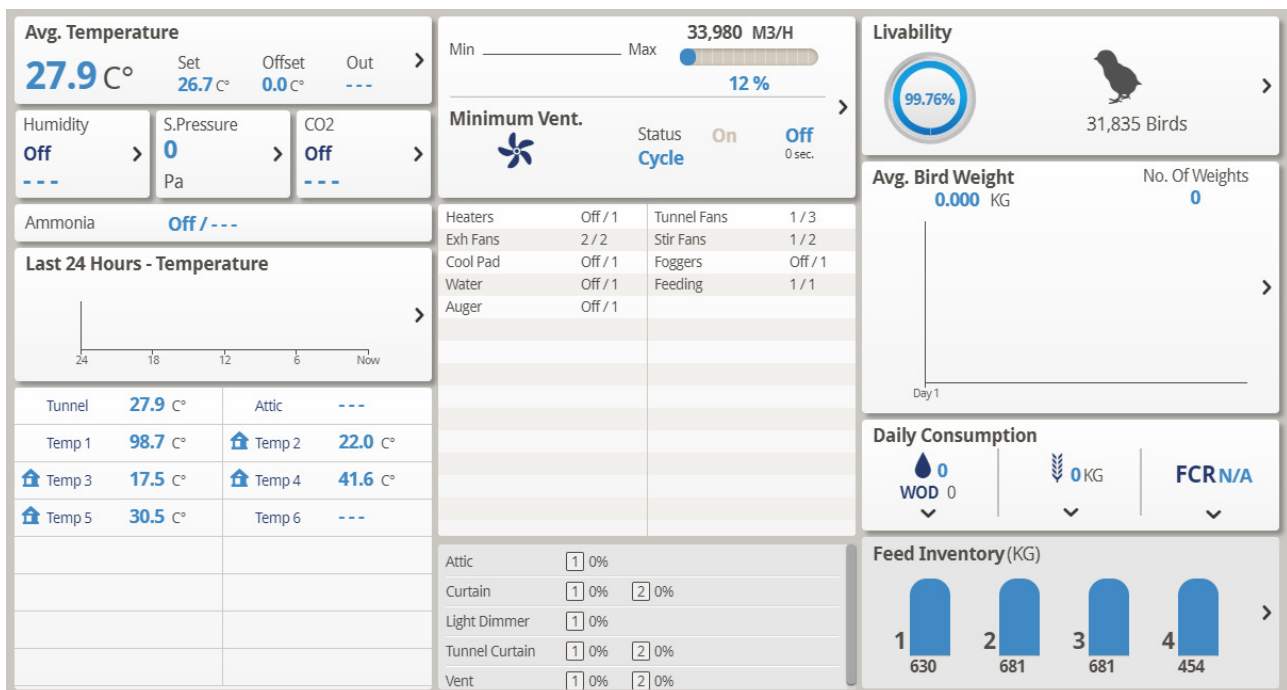

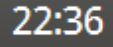
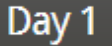
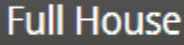
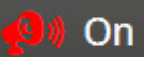



Figure 1: Platinum Touch / Rotem One Main Screen

- **Temperature:** Displays the average temperature, the set point the offset differential, and outdoor temperature. Click on it to go to the [Temperature Curve](#).
- **Ventilation level:** This section displays the current ventilation and percentage of air capacity being utilized. Click on it to go to [Levels of Ventilation](#).
- **Livability:** Current number of living birds and the corresponding percentage relative to the original number. Click on it to go to [Bird Inventory](#).
- **Current relative humidity, static pressure, CO2 & ammonia levels.** Click on it to go to the [Humidity Treatment](#), [Static Pressure](#), [CO2 Treatment](#) and [Ammonia Treatment](#) screens.
- **Average bird weight graph:** This graph summarizes the flock's weight over the growth cycle. Click on it to go to [Bird Weight History](#).

- **Temperature over the last 24 hours.** Click on it to go to the [History View](#).
- **Alarm messages.** The Main Screen lists the latest alarms.
- **Sensors:** This area displays the tunnel and attic target temperatures, the temperature readings for each individual temperature sensor, and the wind speed.
- **Feed Inventory:** Shows the current feed levels in the silos. Click to go to [Feed Inventory](#).

2.2 Menu Elements

Icon	Description
	Click to return to the Main Screen
	Click to open the Menu.
	Displays the current time
	Displays the growth day
	Displays the house status (full house or brood mode)
	Click to turn off alarms. However, Platinum Touch / Rotem One continues to register alarms until alarms are reset.
	Click to read the latest controller error messages (see Alarms History, page 81).
	Hot screens

2.3 Version

- Go to System > Version to see the unit's software version.

Version		
Name	Version	Date
Controller Type	Platinum Pro Broiler Standard	
Controller Version	6.19.2	
UI Server Version	3.5.4.0	11/14/2019 12:39:52 PM
UI Client Version	3.5.4.0	11/14/2019 12:39:44 PM

2.4 Selecting the Mode

Platinum Touch / Rotem One runs in two modes: Broiler and Breeder.

To select the mode:

1. Open the door. Locate the keyboard.
2. Disconnect the power cable from the power source.
3. On the keyboard, press the **Delete** button and reapply power. The Cold Start screen appears.
4. Select **Yes**. **Choose Controller Type** appears.
5. Select the required mode.
6. Press **Enter**.

NOTE The manual is based on the Broiler Mode. Functions that are unique to Breeders are described in Appendix E: Breeder Mode.

3 Control Menu

🔑 Control	Temperature Curve	Foggers	Feed Scale Program
📁 Management	Min Vent Timer	Water & Feed	Light Dimmers
⌚ History	Timer Settings	Light	Dosing Pump Settings
🔧 System	Humidity Treatment	Extra Systems	
🔗 EXT System	CO2 Treatment	Control Mode	
	Static Pressure	System Parameters	
	Cool Pad	Ammonia Treatment	

The following sections detail:

- Temperature Curve
- Minimum Vent Timer
- Timer Settings
- Introduction to Humidity, Ammonia, and CO2 Treatment
- Humidity Treatment
- CO2 Treatment
- Static Pressure
- Cool Pad
- Foggers
- Water & Feed
- Light
- Extra Systems
- Control Mode
- System Parameters
- Ammonia Treatment
- Feed Scale Program
- Light Dimmers
- Water Dosing

3.1 Temperature Curve

- Temperature Curve Main Screen
- Temperature Curve Help | Set Definitions

3.1.1 TEMPERATURE CURVE MAIN SCREEN

This screen sets the temperature targets according to the bird age.

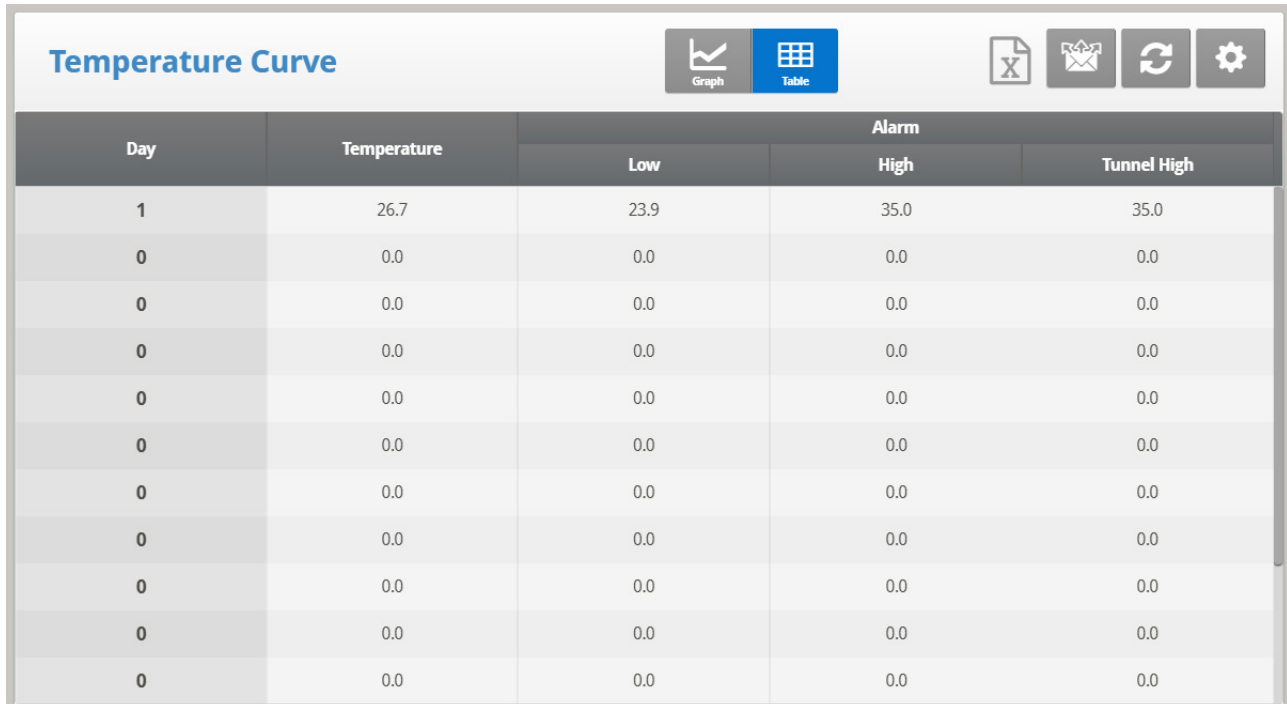

Day	Temperature	Alarm		
		Low	High	Tunnel High
1	26.7	23.9	35.0	35.0
0	0.0	0.0	0.0	0.0
0	0.0	0.0	0.0	0.0
0	0.0	0.0	0.0	0.0
0	0.0	0.0	0.0	0.0
0	0.0	0.0	0.0	0.0
0	0.0	0.0	0.0	0.0
0	0.0	0.0	0.0	0.0
0	0.0	0.0	0.0	0.0
0	0.0	0.0	0.0	0.0
0	0.0	0.0	0.0	0.0

1. In *System > Sensors > Analog*, designate the required number of sensors as temperature sensors. When using more than one sensor, Platinum Touch / Rotem One begins treatments based on the average.

2. In *System > Temperature Definition*, assign specific sensors to devices. If a zone does not have an assigned sensor, calculations are based on the current average temperature.

3. In *Control > Temperature Curve*, define the required target temperature curve.

- Set up to 20 lines, 999 growth days. When a curve is not required enter temperatures in the first line only.
- Define the following parameters:
 - **Day:** Set the growth day. You can program negative growth days up to -2 for pre-warming. To enter a negative growth day, type the day number followed by the ± key.
 - **Temperature:** Set the temperature that triggers heating to begin.
 - **Low and High Alarm:** Set temperature alarm limits.
 - **Tunnel High:** Set a high temperature alarm for Tunnel mode.
 - Version 7.23 enables setting the temperature alarms to 0.X degrees (only when the temperature is set to Celsius).



Day	Target	Heat Off	Tunnel	Alarm		
				Low	High	Tunnel High
1	26.7	25.6	32.2	23.9	35.0	35.0
5	27.0	26.5	32.5	24.5	35.2	35.2

4. In *Management > Alarm Settings*, set the alarms.

5. If required, click  and set the parameters.

- Temperature Curve Help | Set Definitions

3.1.2 TEMPERATURE CURVE HELP | SET DEFINITIONS

Temperature Curve - Settings	
Temperature Curve Offset	0.0 
Set Temperature Change Reminder (Diff.)	1.7 

- **Define:**
 - **Temperature Curve Offset:** Adjusts all temperature curves by this amount. You can use this to temporarily adjust all temperatures up or down for special circumstances. The curve appears in the [Curve Status Hot Screen](#). Use the ENTER and Up or ENTER and Down combinations to change the offset.
 - **Set Temperature Change Reminder (Diff):** Sets the change in set temperature that triggers a reminder for you to set backup thermostats. Often producers forget to set backup thermostats as their birds grow from baby chicks to market age, so the Platinum Touch / Rotem One reminds you. When you press Enter to acknowledge the reminder, the Platinum Touch / Rotem One logs it in the Table of Events.

NOTE '0' disables this parameter (if value is changed an appropriate message is displayed).

3.2 Minimum Vent Timer

This option enables the user to set the minimum ventilation timing.

- Does Minimum Ventilation Work?
- Setting up Minimum Ventilation
- Ramping Timer Help | Set
- Additional Details

3.2.1 HOW DOES MINIMUM VENTILATION WORK?

Ventilation time in the Platinum Touch / Rotem One runs in two modes:

- **Minimum ventilation (MV):** Fans run in an on/off cycle, where the cycle time changes as the temperature changes. Change in the cycle time only happens after a user-defined delay. Since temperatures can fluctuate constantly, the delay ensures stable fan speeds.
- **Continual operation:** Fans remain on until the temperature drops

Figure 2 illustrates the ventilation modes.

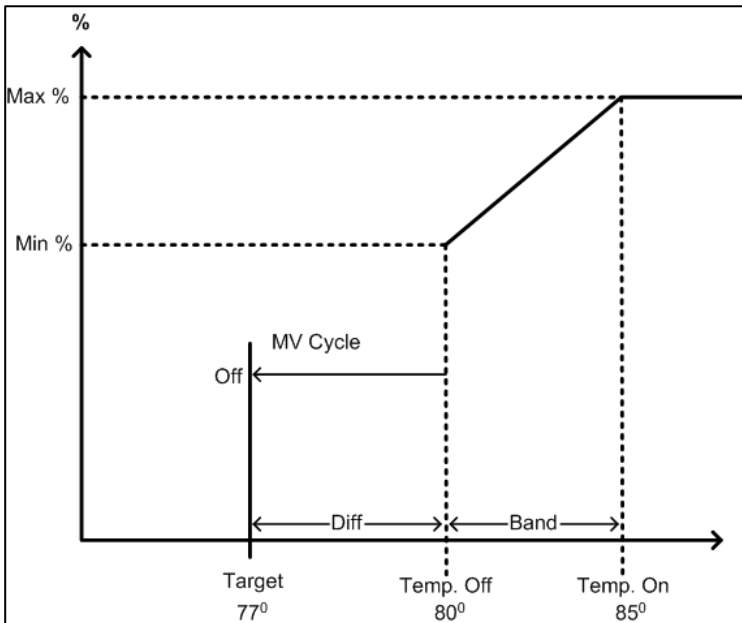

Figure 2: Minimum Ventilation

As shown in the graph:

- When the temperature is below the target temperature, ventilation is off.
- When the temperature is between the Target and Temp. Off temperatures (labeled Diff in the graph) (refer to Figure 6):
 - If the temperature is rising, the fans run according to the cycle settings
 - If the temperature is dropping, the fans continue to run at the calculated on/off time value

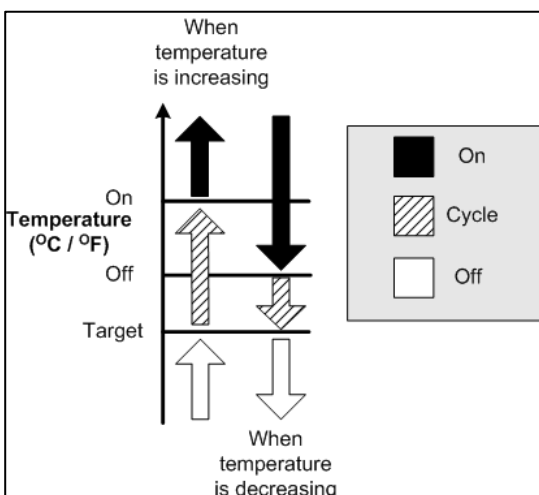

Figure 3: Minimum Ventilation Schemes

- When the temperature is between the Temp. Off and Temp. On temperatures (labeled Band in the graph), the fans run according to the calculated on/off time.
- When the temperature is above the Temp On temperature, the fans run continuously.

In Figure 2:

- Fans are off below 75°
- Between 75° - 80° fans run:
 - At minimum ventilation if the temperature is rising
 - At the calculated on/off time if the temperature is dropping
- Between 80° - 85°, the fans run at the calculated on/off time
- Above 85° the fans run continuously.

3.2.2 SETTING UP MINIMUM VENTILATION

This procedure describes the setup for a house using powered minimum ventilation.

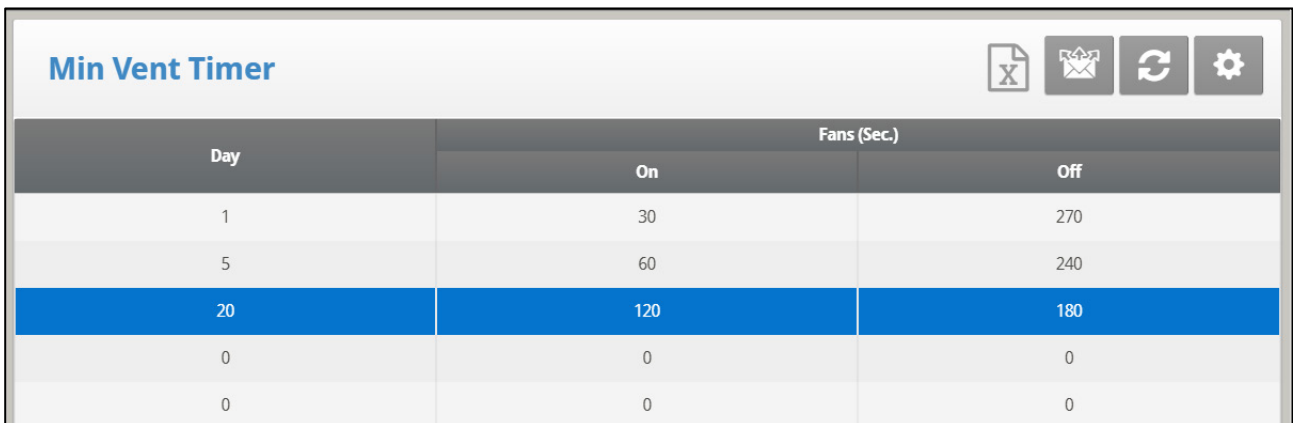

Day	Fans (Sec.)	
	On	Off
1	30	270
5	60	240
20	120	180
0	0	0
0	0	0

1. In *System > Setup*, enable **Minimum Vent**.
2. In *System > Temperature & Timer* for the required fans set the parameters as required.
3. In *Control > Minimum Vent Timer* define:
 - **Day**: Set the growth day.
 - **Fans On/Off**: Set the on/off cycle times.
4. Set the [Ramping Timer Help](#) parameters as required.

3.2.3 RAMPING TIMER HELP | SET

Ramping Timer	
Ramping Enable	<input type="radio"/> No
Increase Decrease Time (Sec.)	60
Ventilation Change (%)	20
Min Off Time (Sec.)	60
Diff. Above SET To Start Ramping	0.6

Ramping means a temporary change in the minimum ventilation. Ramping operates in two manners:



- **Ramping Enable:** Set to No/Yes.
 - **Increase:** When the temperature rises above [Set Temperature + Difference above Set], the minimum ventilation increases by the amount (percentage) set in Ventilation Change.
 - **Decrease:** When the temperature is below [Set Temperature + 0.5° F], the minimum ventilation decreases by the amount (percentage) set in Ventilation Change.
- **Increase Decrease Time:** When ramping ventilation begins, the fans operate at the increased or decreased rate for this amount of time.
- **Ventilation Change:** This parameter determines the amount of change in the Fan Air Capacity. For example, if the capacity is 20,000 CFM and the change is 20%, the CFM's increases to 24,000 CFM. The second time the CFM will increase to 28,800 CFM. Range 5 – 50%; default 20%.
- **Minimum OFF time (sec):** This parameter determines the minimum ventilation off time. Range 10 – 300 seconds; default 60 seconds.
- **Diff Above SET to Start Ramping:** The differential above the Set Temperature point at which ramping increase begins.

3.2.4 ADDITIONAL DETAILS

- When the temperature begins to decrease, the fans remain at the same cycle until the temperature reaches the off temperature. For example, in Figure 5 if the fans are running continually when the temperature drops to 80°, they continue to run continually until the temperature reaches 75°. If the temperature is 78° when the temperature begins to drop, the fan cycle remains the same until the temperature reaches 75°.
- If a heater goes on, all fans begin working at Minimum Ventilation automatically.
- After a power outage, the cycle runs at Minimum Ventilation.

3.3 Timer Settings

This section enables setting the timer schedule. Timers control the cooling devices (foggers/cooling pads) on/off schedule

Timer Settings					
Timers	On (Sec.)	Off (Sec.)			
1	0	0			
2	0	0			
3	0	0			
4	0	0			

1. Define the number of seconds the timer is ON and OFF.
2. In *System > Temp & Timer Settings*, scroll to each cooling device.
3. Under option, select a timer setting.

NOTE: *Unlike the Min. Vent Timer, this cycle timer also operates above the set temperature.*

3.4 Introduction to Humidity, Ammonia, and CO2 Treatment

Platinum Touch / Rotem One provides various options to controlling humidity, CO2, and ammonia levels.

- None: No treatment is provided.
- Level: Ventilation levels increase for a designated amount of time.
- Tunnel or exhaust fan: A designated fan turns on for a designated amount of time. The amount of air blown into the house is greater than that provided by an increase in ventilation level.
- Increase in air / weight: The total amount of air that fans need to provide increases by a user defined amount. Fans stay on until CO2, humidity, or humidity levels fall to their defined levels. This option is only available when using Minimum Ventilation by Weight.
- Humidity treatment by heat: In cold air situations, heaters can be turned on to lower the relative humidity.

If there is a contradiction between CO2, humidity, and ammonia treatments:

- Ammonia treatment has priority over CO2 treatment.
- CO2 treatment has priority over humidity treatment.
- Increase in air / weight has priority over other treatments.
- Humidity treatment by heat takes priority over increasing the ventilation.

3.5 Humidity Treatment

Humidity treatment enables keeping humidity levels within defined levels by controlling the air exchange. Platinum Touch / Rotem One uses a combination of vent openings and ventilation to maintain these levels. When the relative humidity rises above the defined levels, the fans' minimum on time increases by the levels defined in the table below.

- Humidity treatment is functional only when the controller employs minimum ventilation (cycle).
 - If the temperature rises and fans switch to continual operation, Humidity Treatment stops. Humidity Treatment does not prevent the fans from entering continual operation.
 - All fans switch from Minimum Ventilation (cycle ventilation) to continual ventilation as defined in the Temp and Timer Settings screen (refer to Option, page 96). If one fan runs in Minimum Ventilation, Humidity Treatment continues even if other fans operate continually.
- The maximum on time is [cycle time – minimum off time].
- Treatment ends when the relative humidity drops below [target – band].
- When treatment is in progress, the Main Screen displays the Humidity Status.

3.5.1 HUMIDITY TREATMENT MAIN SCREEN

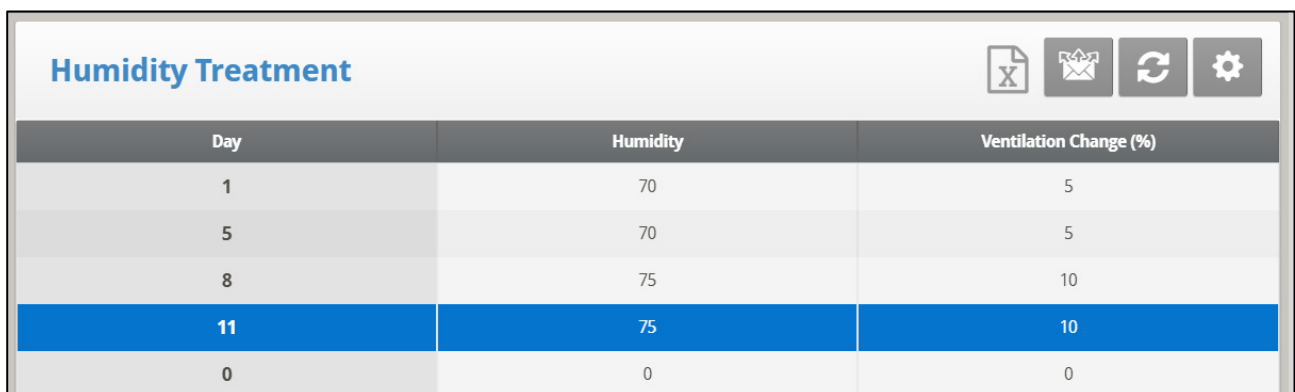

Day	Humidity	Ventilation Change (%)
1	70	5
5	70	5
8	75	10
11	75	10
0	0	0

1. In *System > Analog Sensors* (refer to Analog Sensors page 92), designate up one or two sensors as indoor humidity sensors (outdoor sensor is for information only). When using two sensors, begins treatments based on the average.
2. On the keyboard: If required, go to *Service > Humidity Calibration*, and calibrate the sensors (refer to Humidity Calibration, page 122).
3. In *Control > Humidity Treatment* set the parameters as required.
 - **Day:** Growth day. Can set multiple programs for same day (Maximum number of programs: 20)
 - **Humidity %:** Relative humidity target at which to begin treatment
 - **Ventilation Change%:** Increase minimum ventilation ON time by this percentage.

NOTE: *The increase in ventilation occurs one time only. There is no additional change in the ventilation On Time.*

4. Set the Help parameters.
5. Set the Humidity Sensor Alarm (page 60).

3.5.2 HUMIDITY TREATMENT HELP | SET DEFINITIONS

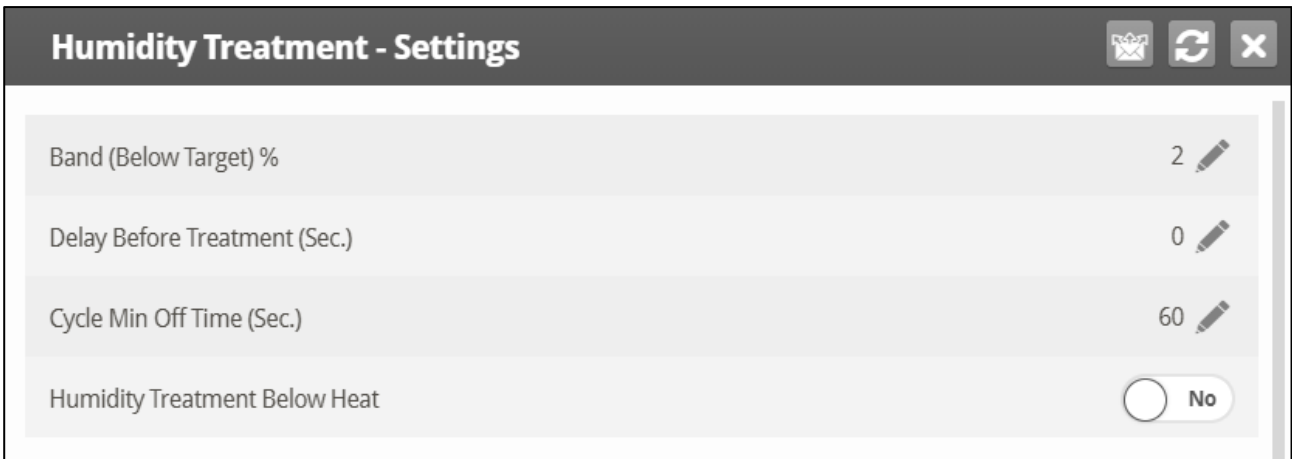

- **Band (Below Target) %:** Once treatment begins, it continues until the relative humidity drops to [target – band].
- **Delay Before Treatment (Sec):** Once the relative humidity rises about the permitted level, Platinum Touch / Rotem One waits this amount of time before beginning treatment.
- **Cycle Minimum OFF Time (sec):** The minimum amount of time treatment ceases in each cycle.
- **Humidity Below Heat:** Enable humidity treatment when the temperature is below the target heat.

3.6 CO2 Treatment

CO2 treatment forces an increase in ventilation level when the CO2 level is too high. When the CO2 level rises above the user-defined level, ventilation increases by a user-defined amount. If during treatment, the CO2 level drops below the **Stop Value** parameter, the ventilation level automatically returns to that level used before CO2 treatment was initiated.

3.6.1 CO2 MAIN SCREEN

Day	Start Value	Stop Value	Ventilation Change (%)
0	100	0	0
0	100	0	0
0	100	0	0
0	100	0	0
0	100	0	0
0	100	0	0

1. In *System > Analog Sensors* (refer to Analog Sensors page 92), designate one sensor as a CO2 sensor.

2. On the keyboard: If required, go to *Service > CO2 Calibration*, calibrate the sensors (refer to Humidity Calibration, page 122).

3. In *Control > CO2 Treatment* set the parameters as required.

- **Day:** Growth day. You can set multiple programs for same day (maximum number of programs: 20)
- **Start Value:** CO2 value at which to begin treatment (Range 100 – 5000)
- **Stop Value:** CO2 value at which to end treatment (Range 100 – 5000)
- **Vent Change (%):** Percentage increase in ventilation

3.6.2 CO2 TREATMENT HELP | SET DEFINITIONS



- **Delay Before Treatment (sec):** Number of seconds the controller pauses before ventilating
- **Cycle Minimum OFF Time (sec):** The minimum amount of time that the fans do not operate during a cycle.
- **CO2 Treatment below Heat:** Select YES or NO to enable CO2 treatment when heaters are operating (set in Temperature Curve).

3.7 Static Pressure

Set target parameters for attic, minimum, and tunnel ventilation.

- In System > **Setup**, enable a static pressure unit.
- Refer to Static Pressure Calibration and Static Pressure.
 - [Static Pressure Method](#)
 - [Disabling the Static Pressure Sensor](#)
 - [Static Pressure Help | Set Definitions](#)

3.7.1 STATIC PRESSURE METHOD

- [Attic Static Pressure](#)
- [Minimum Ventilation Static Pressure](#)
- [Tunnel Ventilation Static Pressure](#)

3.7.1.1 Attic Static Pressure

The screenshot shows the 'Static Pressure' control interface. At the top, there are three tabs: 'Attic Ventilation' (selected and highlighted in blue), 'Minimum Ventilation', and 'Tunnel Ventilation'. Below the tabs, there is a table with two rows:

Setting	Value
Low S.Pressure Setting	9
High S.Pressure Setting	14

- **Define:**
 - **Low Pressure:** Set required low pressure for Attic Ventilation (minimum opening).
 - **High Pressure:** Set required high pressure for Attic Ventilation (maximum opening). Minimum Ventilation Static Pressure

The screenshot shows the 'Static Pressure' control interface with the 'Minimum Ventilation' tab selected and highlighted in blue. Below the tabs, there is a table with six rows:

Setting	Value
First Low S.Pressure	19
First High S.Pressure	29
Second Low S.Pressure	14
Second High S.Pressure	24
Low S.Pressure Alarm	2
High S.Pressure Alarm	52

- **Define:**
 - **1st Low Pressure:** Set desired static pressure for low outside temperature conditions. Be sure that there is proper airflow at this setting.
 - **1st High Pressure:** Set desired static pressure for high temperature conditions. Normally this pressure is lower to obtain a larger air inlet opening.

NOTE: Controller interpolates between the LOW and HIGH Temperature.

- **Low Pressure Alarm:** Set alarm for low static pressure. If you disable it by setting zero, the Platinum Touch / Rotem One warns you and enters a record in the Table of Events.
- **High Pressure Alarm:** Set alarm for high static pressure.

3.7.1.2 Tunnel Ventilation Static Pressure

Static Pressure		
Attic Ventilation	Minimum Ventilation	Tunnel Ventilation
Low S.Pressure	14	
High S.Pressure	24	
Low S.Pressure Alarm	2	
High S.Pressure Alarm	37	

- **Define:**
 - **Low Pressure:** Set required low pressure for Tunnel Ventilation (minimum opening).
 - **High Pressure:** Set required high pressure for Tunnel Ventilation (maximum opening).
 - **Low Pressure Alarm:** Set alarm for low static pressure.
 - **High Pressure Alarm:** Set alarm for high static pressure.

3.7.2 DISABLING THE STATIC PRESSURE SENSOR

To disable the static pressure sensor:

1. Go to System > [Setup](#).
2. Set the Static Pressure Unit to **None**.

The main screen stops:

- displaying the pressure
- displaying High Pressure and Pressure Sensor Failure alarms

NOTE If either of these alarms were active before disabling the sensor, the main screen continues to display the alarms. Reset the alarms one time to cease the display.

3.7.3 STATIC PRESSURE HELP | SET DEFINITIONS

Static Pressure - Settings			
Static Pressure			
Wind Gust Delay Time (Sec.)	10	S.Pressure During Tunnel	Yes <input type="radio"/>
Transitional Tunnel	Yes <input type="radio"/>	Minimum Ventilation Using	Vent
Emergency S.Pressure Delay (Sec.)	60	Curtain Position In Emergency S.Pressure (%) (0-Disabled)	100
Min Tunnel Curtain Position (%)	30	Min Tunnel Curtain (%) To Start Fan	30
2nd S.P At This Fan Temp. On	None		

- **Define:**
 - **Wind Gust Delay Time (sec):** Set length of time (seconds) before starting Static Pressure control after an unexpected change in air pressure.
 - **Static Pressure During Tunnel:** Select YES or NO for using Static Pressure control when in Tunnel mode.
 - **Transitional Tunnel:** Select YES or NO for using tunnel inlets when static pressure is high and vents are already at 100%
 - **Minimum Vent Using:** Select Vent or Tunnel for controlling static pressure when in minimum ventilation.
 - **Emergency S. Press. Delay (sec.):** Length of time Platinum Touch / Rotem One waits before taking emergency action when static pressure remains above the high-pressure alarm setting. Note that chronologically it is important to open and go to the next setting.
 - **Curtain Position in Emergency Static Pressure %:** Set the position non-active curtains should go to in an emergency pressure situation.
 - **Min Tunnel Curtain Position (%):** When using static pressure in tunnel mode, tunnel inlet opens at least this far in tunnel mode.
 - **Min Tunnel Curtain % to Start Fan:** Set a value that serves as a minimum to begin fan operation in tunnel mode.
 - **2nd S.P. At This Fan Temp ON:** When the defined fan turns on, Platinum Touch / Rotem One switches to the second static pressure parameter.

3.8 Cool Pad

- Cool Pad (Standard), Version 7.21 and Below
- Cool Pad (Ramping), Version 7.22 and Above

3.8.1 COOL PAD (STANDARD), VERSION 7.21 AND BELOW

- Cool Pad, Main Screen
- Cool Pad Help | Set Definitions

3.8.1.1 Cool Pad, Main Screen

This menu sets the operating conditions for the Cool Pad.

Cool Pad						
Day	Start Time	End Time	On Temp Diff	To Humidity	On (Sec.)	Off (Sec.)
0	00:00	00:00	0.0	0	0	0
0	00:00	00:00	0.0	0	0	0
0	00:00	00:00	0.0	0	0	0
0	00:00	00:00	0.0	0	0	0
0	00:00	00:00	0.0	0	0	0
0	00:00	00:00	0.0	0	0	0

1. In *System > Relay Layout*, define a relay(s) as cooling pad.

2. In *Control > Cool Pad*, define the parameters below.
3. In *System > Temperature & Timer*, scroll to each cool pad.
4. Under *Option*, select *Prog.*

NOTE: To enable this screen, you must select *Prog.*

5. Set the Help parameters as required.
 - **Day:** Set growth day.
 - **Start Time:** The cool pad begins operating.
 - **End Time:** The cool pad ceases to operate.
 - It is possible to set multiple start and stop times for a single day.
 - In the screen above, growth day jumps from day 7 to day 14, the cool pad continues to work according to day 7 settings from growth day 7 through growth day 14.
 - **On Temperature Difference:** Set difference from tunnel temperature to use this setting. You can use negative differential temperatures.
 - Note the settings for Day 14. Platinum Touch / Rotem One uses the maximum temperature differential that applies to determine the correct settings.
 - **To Humidity:** Set maximum humidity allowed before stopping cool pad. You can enter 100%.
 - **On Sec:** Set the maximum on time for each cycle of cool pad operation.
 - **Off Sec:** Set the minimum off time for each cycle of cool pad operation.

3.8.1.2 Cool Pad Help | Set Definitions

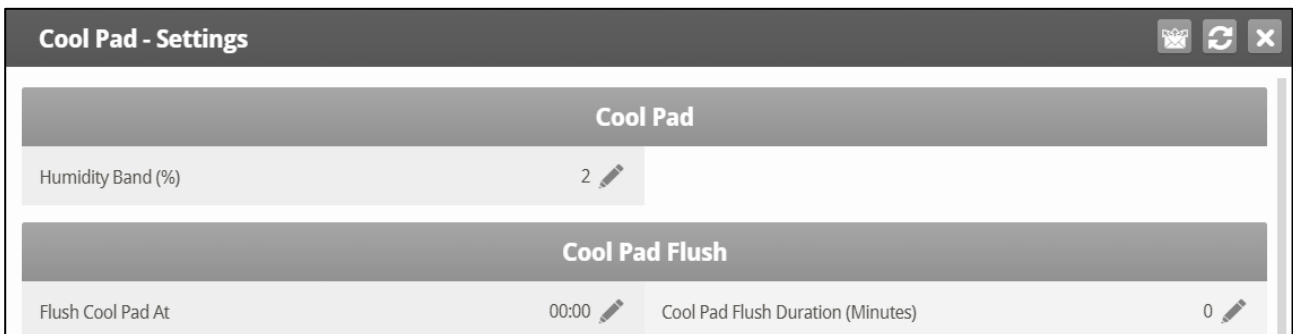

- **Humidity Band (%):** Define the on/off hysteresis relative to humidity.
- **Flush Cool Pad At:** Set time of day (hh:mm) to start a continuous application of water to the cool cells in order clean them of any deposits.
- **Cool Pad Flush Duration (minutes):** Set the length of time in minutes for flushing. If parameter is set, flush is applied without regard to ventilation level or operating mode.

Example: Cool Pad ON temperature = 80°, Diff set to 2° F:

Cool Pad #	Assigned Sensor	Diff Between Cool Pads Stage	Actual ON Temperature
1	Average	0.0	80°
2	Average	2.0	82°
3	Temp Sensor 2	0.0	80°

4	Temp Sensor 2	2.0	82°
---	---------------	-----	-----

3.8.2 COOL PAD (RAMPING), VERSION 7.22 AND ABOVE

As an option, Version 7.22 supports Cool Pad Ramping. Please note that Version 7.22 also supports the non-ramping option.

Ramping means that the user defines under what climatic conditions cool pads begin to operate (sequentially or simultaneously). In addition, the user defines the cool pads minimum and maximum off times. As the temperature changes, the controller automatically adjusts the off time. The cool pad(s) continues to operate until the temperature decreases to a user-defined point. The user sets the following parameters to configure ramping:

- On/Off temperatures.
- Ramping range is the temperature range (above the Cool Pad ON temperature) in which ramping takes place. If the temperature rises above the defined range, ramping ceases.
- The user defines the On time, which remains constant for each day, and the minimum/maximum Off times. The controller automatically adjusts the Off time as the temperature changes.
- You can specify which hours during the day when cooling can take place.
- You can define how the humidity affects the cool pads.

NOTE: *Incorporating humidity levels in the operating parameters requires installing a humidity sensor. Invalid sensor readings disable these conditions.*

3.8.2.1 Cool Pad Main Screen

➡ Define relays as cool pads. Refer to Relay Layout, page 90.

To configure Cool Pad Ramping:

1. On the Keyboard, go to Control > Control Mode and enable Cooling Ramping.

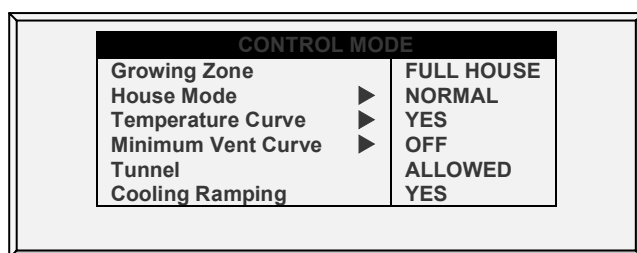

2. Go to System > Temp & Timer Setting.

Temperature & Timer Settings						
Device	On	Off	MNT			Option
			Min Vent	Natural	Tunnel	
Cool Pad 4	31.7	31.1	<input type="checkbox"/>	<input type="checkbox"/>	<input checked="" type="checkbox"/>	None ▼
Cool Pad 3	31.7	31.1	<input type="checkbox"/>	<input type="checkbox"/>	<input checked="" type="checkbox"/>	None ▼
Cool Pad 2	31.7	31.1	<input type="checkbox"/>	<input type="checkbox"/>	<input checked="" type="checkbox"/>	None ▼
Cool Pad 1	31.7	31.1	<input type="checkbox"/>	<input type="checkbox"/>	<input checked="" type="checkbox"/>	None ▼
Tunnel Setting	31.1	29.4	<input type="checkbox"/>	<input type="checkbox"/>	<input type="checkbox"/>	▼
Set Temperature	26.7	---	<input type="checkbox"/>	<input type="checkbox"/>	<input type="checkbox"/>	▼

3. Define the On and Off temperatures. For details on other parameters, refer to Temp & Timer Settings.

4. Go to Control > Cool Pad.

Cool Pad			
Day	On Time	MaxOff Time	MinOff Time
1	300	100	100
0	0	0	0
0	0	0	0
0	0	0	0

5. Define:

- **Day:** Defines the growth day at which the cooling function takes place. Only one line per day is valid. If more than one line defines the same day, the last line only defines the function.
- **On Time:** Define the operating time. Range: 0 – 999 seconds. Default: 0
- **Maximum Off Time:** Define the maximum amount of time that a cool remains off before restarting. Range: 0 – 999. Default: 0. Set the time to 0 for continuous operation.
- **Minimum Off Time:** Define the minimum amount of time that a cool remains off before restarting. Range: 0 – 999. Default: 0

6. Define the Set Definitions (options).

3.8.2.2 Cool Pad Help | Set Definitions

Cool Pad - Settings
⊞ ↺ ✕

Cool Pad

Enable Cooling From Time	00:00	Enable Cooling To Time	00:00
Ramping Temperature Range	5.0	Humidity % To Stop Cooling	100
Humidity Band %	5		

Cool Pad Flush

Flush Cool Pad At	00:00	Cool Pad Flush Duration (Minutes)	0
-------------------	-------	-----------------------------------	---

- Define:
 - **Enable Cooling From/To Time:** Define the hours between which cooling pads can operate. Range: 00:00 – 23:59. Default: 00:00 (always enabled)
 - **Ramping Temperature Range:** Define the maximum temperature at which ramping takes place. Ramping takes place between the On Temperature (+ 0.5°) and this point. For example if cooling begins at 75°, and the ramping range is 10°, ramping continues until the temperature reaches 85.5°. Range: 0 – 36° F/0 – 20° C. Default: 36°/20°.
 - **Humidity % to Stop Cooling:** Above this level, cooling ceases. Range 0 – 100%. Default: 100%.

NOTE As cool pads operate, the humidity can rise to the level that causes cool pads to stop operating.

- **Off Humidity Band:** Define the drop in humidity that must occur before cooling restarts (after cooling ceases because of high humidity). Range: 0 – 20%. Default: 5%

3.9 Foggers

This menu sets the operating conditions for the Foggers.

NOTE: Foggers and cooling pads operate according to the same parameters.

3.9.1 FOGGERS MAIN SCREEN

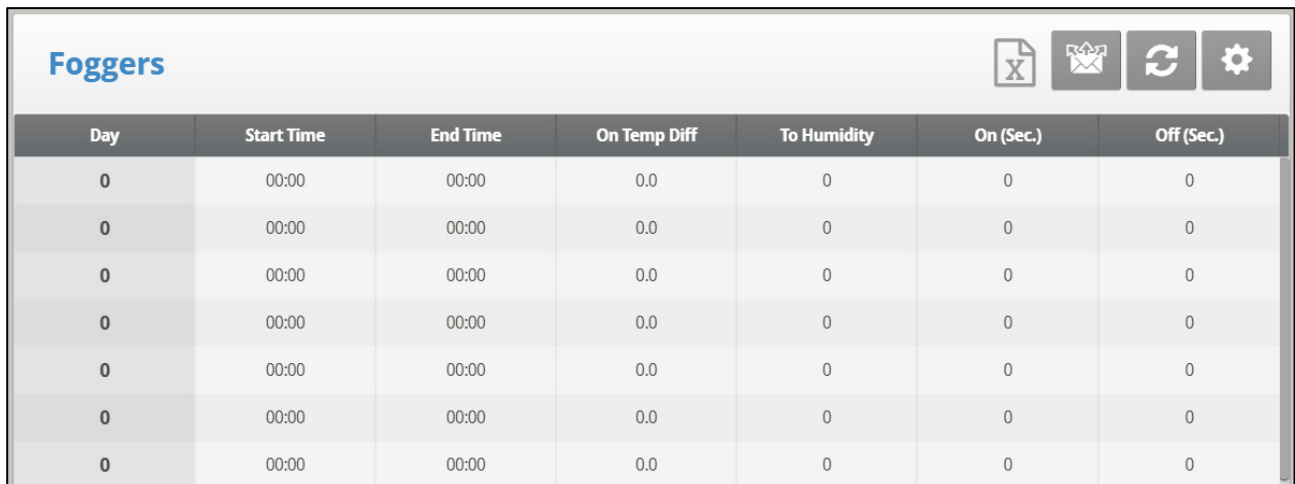

Day	Start Time	End Time	On Temp Diff	To Humidity	On (Sec.)	Off (Sec.)
0	00:00	00:00	0.0	0	0	0
0	00:00	00:00	0.0	0	0	0
0	00:00	00:00	0.0	0	0	0
0	00:00	00:00	0.0	0	0	0
0	00:00	00:00	0.0	0	0	0
0	00:00	00:00	0.0	0	0	0
0	00:00	00:00	0.0	0	0	0

1. In *System > Relay Layout*, define a relay(s) as fogger.
2. In *Control > Foggers*, define the parameters below.
3. In *System > Temperature & Timer*, scroll to each fogger.
4. Under Option, select Prog.

NOTE: To enable this screen, you must select Prog.

5. Set the Help parameters as required.
 - **Day:** Set growth day
 - **Start Time & End Time:** Time of day you want foggers to start and stop.
 - It is possible to set multiple start and stop times for a single day.
 - In the screen above, the first programmed line is at day 47. The foggers do not operate before growth day 47 in this case. Since there are no entries other than day 47, the day 47 program lines apply from then on.
 - **On Temperature Difference:** Set difference from tunnel temperature to use this setting. You can use negative differential temperatures.
 - Note the settings for Day 14. Platinum Touch / Rotem One uses the maximum temperature differential that applies to choose the correct settings.
 - **To Humidity:** Set maximum humidity allowed before stopping foggers.
 - **On Sec:** Set the maximum on time for each cycle of fogger operation.
 - **Off Sec:** Set the minimum off time for each cycle of fogger operation.

3.9.2 FOGGERS HELP | SET DEFINITIONS

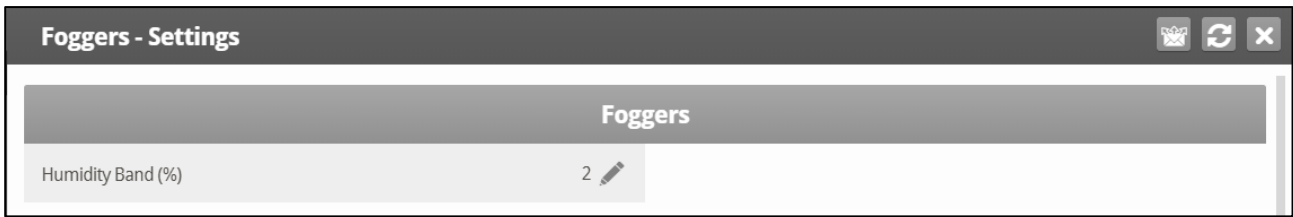

- **Humidity Band (%):** Define the on/off hysteresis (lag) relative to humidity.

3.10 Water & Feed

- Water and Feed Main Screen
- Water and Feed Help | Set Definitions

3.10.1 WATER AND FEED MAIN SCREEN

This menu sets the operating conditions for water and feed devices.

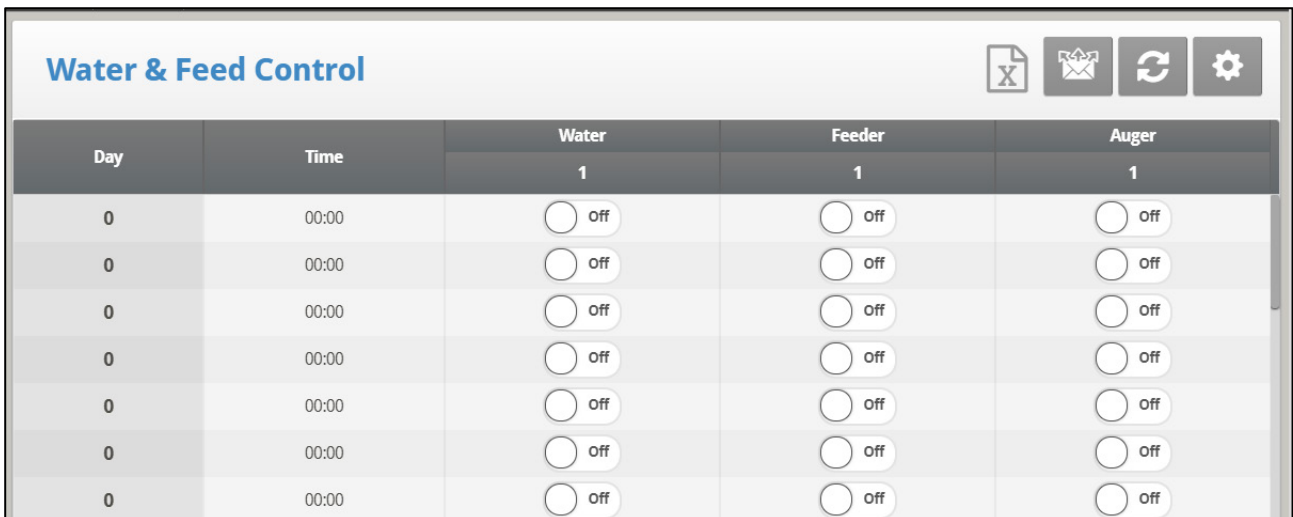

1. Go to System > Relay Layout.
2. Define the relays as required.
3. Go to System > Water and Feed.
4. Define the parameters.
 - **Day:** Set growth day. You can define days as negative days. Enter the number and then press the +/-key.
 - **Time:** Set event times for water, feeder, or auger. Check marks indicate ON at the event time, and dots indicate OFF. Toggle between check marks and dots with the +/- keys.
 - **Water:** Select a check mark to mark water lines to turn on, dot the ones to turn off.
 - **Feeder:** Check mark feed lines to turn on, dot the ones to turn off.
 - **Auger:** Check mark auger lines to turn on, dot the ones to turn off.

NOTE: You can implement mealtime, clean up meals and other options similarly as shown earlier in the light programs.

3.10.2 WATER AND FEED HELP | SET DEFINITIONS

These parameters define the feed and water delivery schedule through the week.

NOTE: The Water and Feed parameters work in conjunction with the Lighting parameters.

- **Daily:** Same schedule for every day of the week.

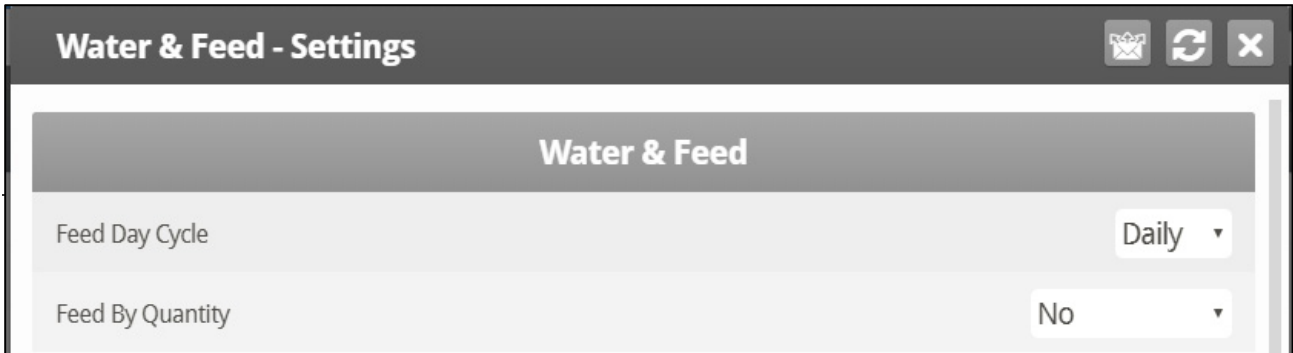

The screenshot shows a window titled "Water & Feed - Settings". Inside, there is a section titled "Water & Feed". Below this section, there are two settings: "Feed Day Cycle" with a dropdown menu set to "Daily", and "Feed By Quantity" with a dropdown menu set to "No".

- **2 – 6 Days:** Select a cycle that lasts the number of days chosen and then repeats itself. For example, 2 Days means that the cycle lasts two days and then repeats itself.

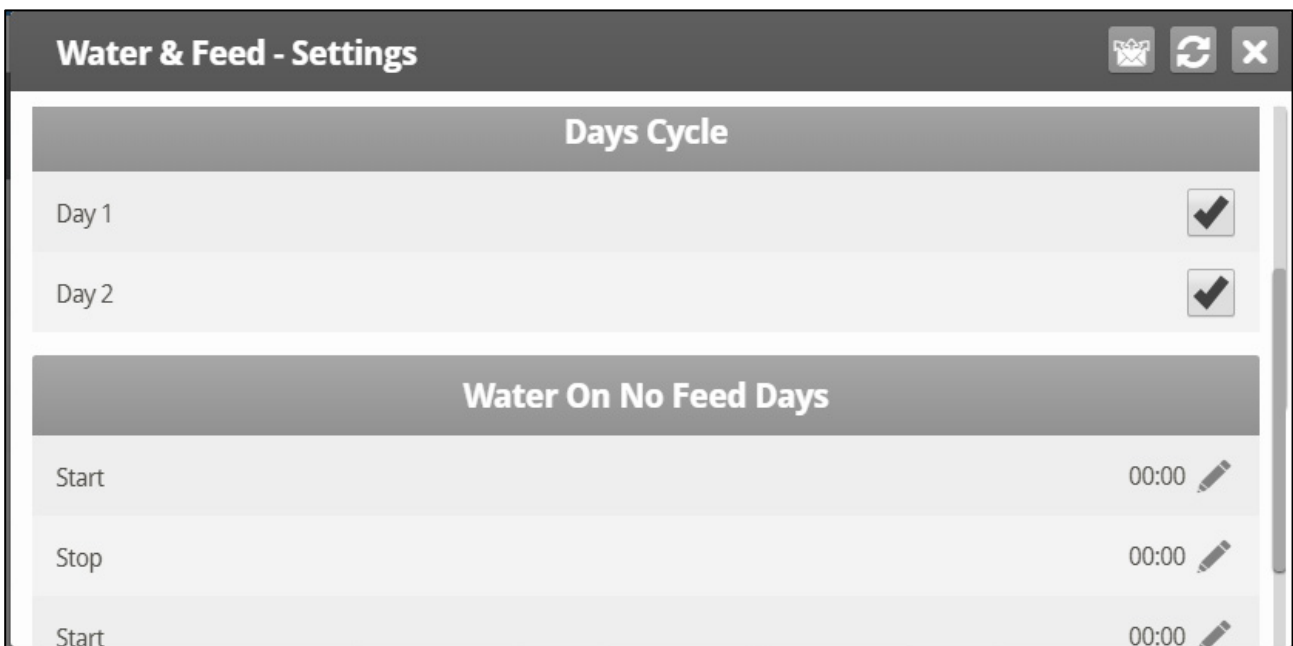

The screenshot shows a window titled "Water & Feed - Settings". Inside, there are two sections: "Days Cycle" and "Water On No Feed Days". The "Days Cycle" section has two rows: "Day 1" and "Day 2", each with a checked checkbox. The "Water On No Feed Days" section has three rows: "Start", "Stop", and "Start", each with a time value of "00:00" and a pencil icon for editing.

- **Week:** Select which days in the week that feed and water are delivered.

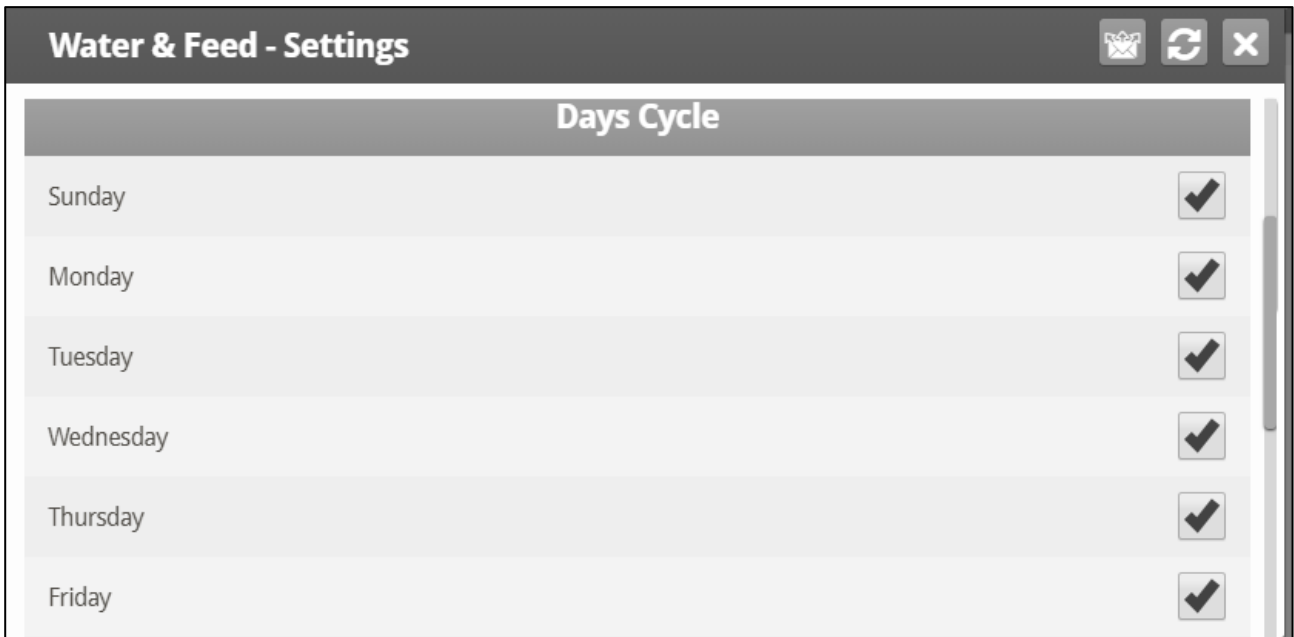

NOTE: If you choose Daily, the Scale function is always enabled. If you choose 2- 6 Days or Week, the Scale function is **disabled** on non-feeding days.

NOTE: If you want to provide feed every day, select Daily. Selecting Week and marking each day causes problems with this function.

If you select the 2 – 6 Day schedule or the Week schedule, configure:

- **Days Cycle (2 – 6 Days):** Select which days in the cycle that feed and water is delivered.
- **Week Cycle:** Select the days that feed and water is delivered.
- **Water on No Feed Days:** Select up to two time periods when water is delivered on non-feed days.

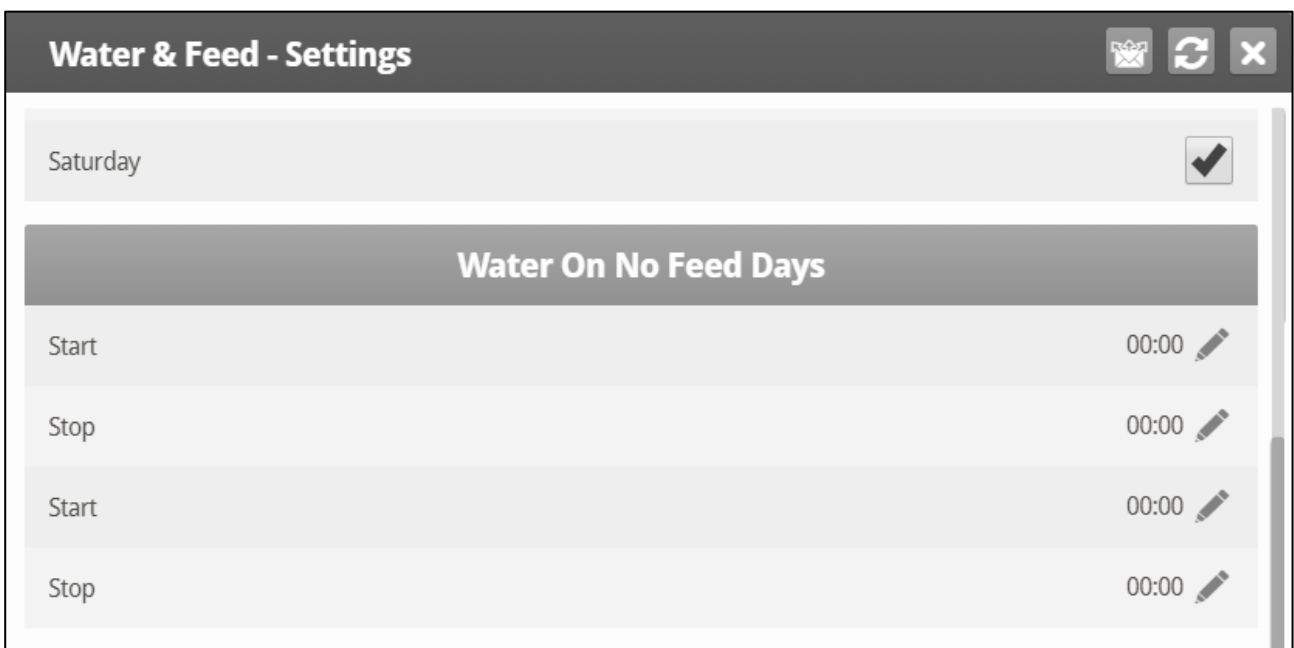

NOTE On feed days, water is delivered when feed is delivered.

3.11 Light

- Light Main Screen
- Light Help | Set Definitions
- Light Measurement Control

3.11.1 LIGHT MAIN SCREEN

This menu sets the lights operating conditions. The controller has a capacity for up to four channels of On/Off Lights and up to 10 channels of Dimmer Lights. In addition, this menu enables using a light sensor.

1. Do one or both:
 - In *System > Analog Output*, define up to four outputs as light dimmers.
 - In *System > Relay Layout*, define up to four outputs as light.
2. In *Control > Water & Feed > Help*, define Feed by Cycle.
3. In *Control > Light*, define the parameters as required.
4. Select **Light Feed**. The Light parameters screen appears. These parameters configure the Light functions on feed days.

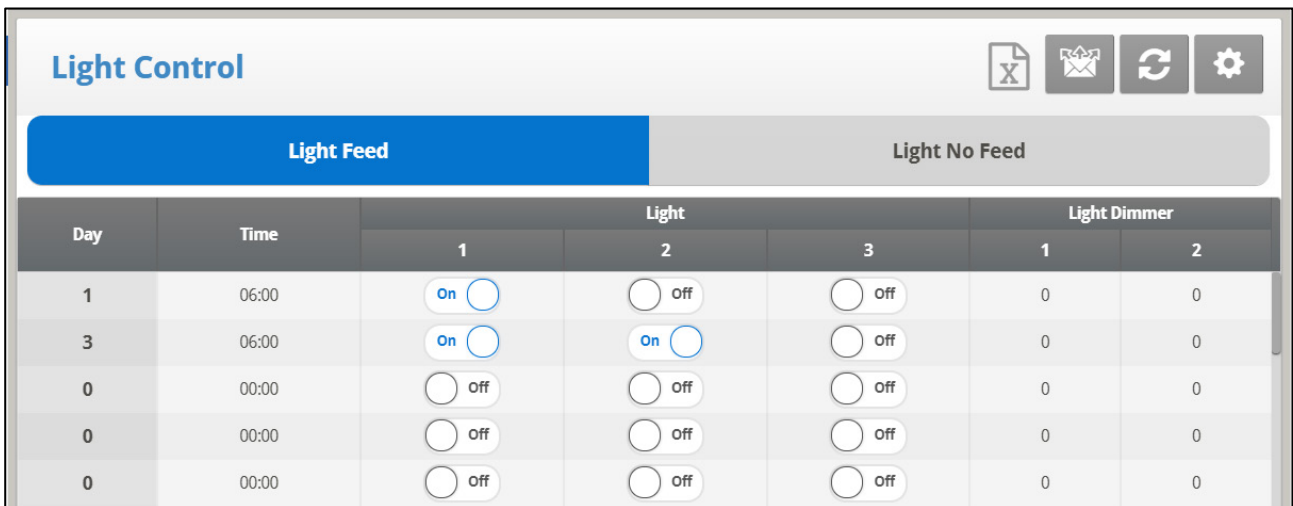

The screenshot shows the 'Light Control' interface. At the top, there is a 'Light Control' title and several icons (document, envelope, refresh, settings). Below the title is a navigation bar with 'Light Feed' (selected) and 'Light No Feed'. The main area is a table with columns for 'Day', 'Time', 'Light' (with sub-columns 1, 2, 3), and 'Light Dimmer' (with sub-columns 1, 2). The table contains five rows of data.

Day	Time	Light			Light Dimmer	
		1	2	3	1	2
1	06:00	On <input checked="" type="radio"/>	<input type="radio"/> Off	<input type="radio"/> Off	0	0
3	06:00	On <input checked="" type="radio"/>	On <input checked="" type="radio"/>	<input type="radio"/> Off	0	0
0	00:00	<input type="radio"/> Off	<input type="radio"/> Off	<input type="radio"/> Off	0	0
0	00:00	<input type="radio"/> Off	<input type="radio"/> Off	<input type="radio"/> Off	0	0
0	00:00	<input type="radio"/> Off	<input type="radio"/> Off	<input type="radio"/> Off	0	0

5. Define:

- **Day:** Set Growth Day
In the example, the brood lights (channel 1) and bright center lights (channel 2) turn on from day 1, while the grow end lights (channel 3) are off. The example shows two channels of light dimmer, Channel 1 at 100% and Channel 2 at 0% (for baby chicks in the brood zone).
- **Time:** Set event times for the lights.
 - On day 12, the center lights turn off, and the dimmer lights go to 45%. There are two periods of darkness: from 01:00 to 03:00 in the morning, and 09:00 PM to midnight. This program repeats until day 25.
 - From day 25 the on/off lights stay off, and the dimmer lights provide dim light during the on periods and go out fully for two periods of darkness. The dark periods total 6 hours, being from midnight to 03:00 AM and from 08:00 PM (20:00) to 11:00 PM (23:00).
- **On/Off:** Select the required light(s) to turn on.



- **Light Dimmer (%):** Set intensity in percentage for light dimmer(s). Dimmer lights start to brighten if the intensity increases, and complete dimming if the intensity decreases at the set time. That is, they start dimming the 'sunset time' in advance of the set time (see **Help | Set** below).









6. If the Feed by Cycle is set to 2- 6 Days, select **Light No Feed**. The Light parameters screen appears. These parameters configure the Light functions on non-feed days.

7. If required, click  and set the parameters.

3.11.2 LIGHT HELP | SET DEFINITIONS

Light - Settings

Light			
Sunrise Time (Min.)	10		Sunset Time (Min.)
Sunset Time (Min.)	10		Allow Spiking From Day
Allow Spiking From Day	1		Spike Cycle (Min.)
Spike Cycle (Min.)	0		Spike Duration (Min.)
Spike Duration (Min.)	0		Spike Increase Amount (%)
Spike Increase Amount (%)	0		Signal Light Is:
Signal Light Is:	None		Signal Before Feed (Sec.)
Signal Before Feed (Sec.)	0		Signal During Feed (Sec.)
Signal During Feed (Sec.)	0		Light Sensor Active
			<input type="checkbox"/> No

- **Define:**
 - **Sunrise Time (minutes):** The amount of time required for the light intensity to rise from 0% to the designated level.
 - **Sunset Time (minutes):** The amount of time required for the light intensity to decline from the designated level to 0%.
 - **Allow Spiking from Day:** The day spiking begins.
 - **Spike Cycle (minutes):** The time length that the spike is at its maximum level. Reaching the maximum level and returning to the preset level both take one minute. For example if the spike duration is 10 minutes, the spike cycle is 8 minutes.
 - **Spike Duration (minutes):** The total amount of time of the spike cycle, including the rise and fall times.
 - **Spike Increase Amount (%):** Set the increase in intensity for the spike in relation to the current light intensity.
 - **Signal Light Is:** Only one light operates during feeding times. Select which light is lit or choose "None".

NOTE After the feeding period ends, all lights selected in the Light Parameters screen relight.

- **Signal Before Feed (seconds):** Amount of time before the feeding starts, that all other lights go off.
- **Signal During Feed (seconds):** Amount of time that the selected light remains on after feeding ends.

NOTE The above two parameters are disabled on no feed days.

- **Light Sensor Active:** The light sensor turns off all lights when sufficient outside light exists. If a light sensor is installed, enable this option to turn off the light during feeding time when there is sufficient outside light. Refer to [Light Sensor Calibration](#) for details.

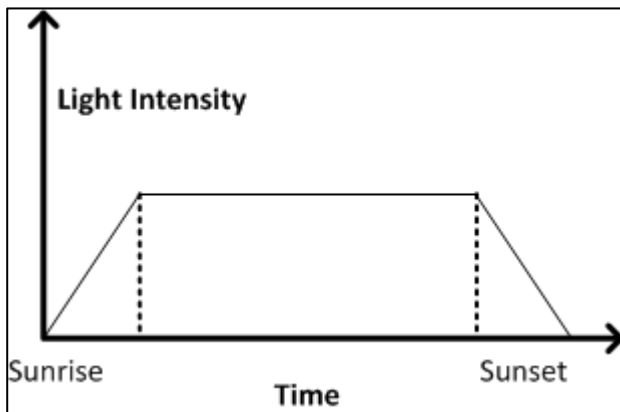

Figure 4: Lighting without Spiking

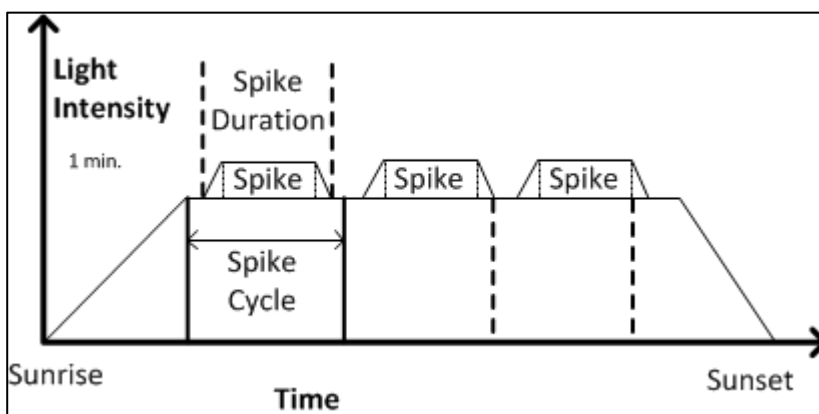

Figure 5: Lighting with Spiking

NOTE The initial reference time for the Spike Cycle is the end of Sunrise. The spike begins Spike Duration minutes before the end of the Spike Cycle and has one minute up and down ramps in intensity. If Sunrise Duration is set to zero, no spiking occurs.



3.11.3 LIGHT MEASUREMENT CONTROL

Version 7.20 supports employing a LUX light sensor to control the light intensity. In this function, the Target LUX is the defined light intensity target. The controller measures the light intensity in LUX values and adjusts the output accordingly.

- On/OFF Light Function does not operate when using Light Dimming by LUX.
- Sunrise/Sunset functions do not operate when using Light Dimming by LUX.

To configure light measurement:





1. In System > Sensors > Analog, define a sensor as Light 0 – 40 LUX.

Sensors  

Analog **Digital**

Output No.	Function	Sensor No.
↳ Card 1 Main Slot 2		
1	Temperature ▼	1
2	Temperature ▼	2
3	Temperature ▼	3
4	Temperature ▼	4
5	Temperature ▼	5
6	Light Sensor Lux ▼	1

2. Go to Control > Light. Target LUX only appears if a sensor is defined.

Light Control    

Light Feed **Light No Feed**

Day	Time	Target Lux	Light		Light Dimmer
			1	2	2
1	00:00	0	On <input type="radio"/>	On <input type="radio"/>	0
1	01:00	0	On <input type="radio"/>	On <input type="radio"/>	0
1	02:00	0	On <input type="radio"/>	On <input type="radio"/>	0
1	03:00	0	On <input type="radio"/>	On <input type="radio"/>	0
1	04:00	0	On <input type="radio"/>	On <input type="radio"/>	0

3. Define the target.

4. If required, click  and set the parameters.

5. Define:

- LUX Band (LUX): No change in light output takes place while the measured amount of light is within this band (percentage). Default 2. Range 2 – 10.
- Increase Interval Time (sec): The interval time for the light intensity to increase (by 1%) from the previous change. Default. Range 0 – 120.
- Decrease Interval Time (sec): The interval time for the light intensity to decrease (by 1%) from the previous change. Default. Range 0 – 120.

6. Set the Low Light Intensity Alarm, page 60 (optional).

3.12 Extra Systems

This menu sets the parameters of other devices that are not listed in the controller.

Extra Systems								
System	Start Time	End Time	Temperature		Humidity		On (Sec.)	Off (Sec.)
			From	To	From	To		
1	00:00	00:00	0.0	0.5	0	0	0	0
2	00:00	00:00	0.0	0.5	0	0	0	0
3	00:00	00:00	0.0	0.5	0	0	0	0
4	00:00	00:00	0.0	0.5	0	0	0	0

1. In *System > Relay Layout*, define relays as Extra System.

2. Go to *Control > Extra System*.

3. Define:

- **Start Time:** Time at which this Extra System starts.
- **End Time:** Time at which this Extra System stops.
- **Temperature From:** Temperature above which Extra System operates.
- **Temperature To:** Temperature below which Extra System operates.
- **Humidity From:** Humidity above which Extra System operates
- **Humidity To:** Humidity below which Extra System operates.
- **On (Sec):** On time for the Extra System. If set to 0, the extra system does not operate.
- **Off (Sec):** Off time for Extra System after completion of on time. If you have values in both **ON** and **Off**, the extra system cycles. If you have zero OFF time, and any ON time, the system simply stays on as long as the other parameters are satisfied.

NOTE All parameters must be satisfied for an Extra System to operate. For example if the temperature is below the From Temperature or the Humidity below the From Humidity, the system is OFF. You can assign specific temperature sensors to an Extra System in [Install | Temp Definition](#). The Extra System uses the Inside Humidity, not the Outside Humidity. If there is no humidity sensor, the Extra Systems ignore the humidity parameters.

3.13 Control Mode

Select house-operating modes, turn temperature curves on or off and select which type of min/max level method to use.

- Control Mode Main Screen
- Catching Mode

3.13.1 CONTROL MODE MAIN SCREEN

The screenshot shows the 'Control Mode' interface with the following settings:

Setting	Value
Growing Zone	Full House
House Mode	NORMAL
Temperature Curve	On
Min Vent. Curve	Off
Tunnel	Allowed

- **Define:**
 - **Growing Zone:** Select whether the house is in one of the brood set-ups or in full house.
 - **House Mode:** Select:
 - Normal
 - Empty: All alarms and functions are disabled.
 - Catching: Refer to Catching Mode.
 - **Temperature Curve:** If you select OFF, temperature settings become fixed values until midnight on the next setting in [Temperature Curve](#).
 - **Minimum Vent Curve:** Set ON/OFF for automatic minimum ventilation ramping
 - On: A curve according to days
 - Off: Time changes at start day of each line in Min Vent tables
 - **Tunnel:** Select either to NOT ALLOW or ALLOW tunnel ventilation.

3.13.2 CATCHING MODE

The screenshot shows the 'Control Mode' interface with the following settings:

Setting	Value
Growing Zone	Full House
House Mode	CATCHING
Temperature Curve	On
Min Max Levels Control	By Weight
Heat Cycle	No
Analog Heat Mode	Linear
THI Mode	Yes

Catching Mode is used when birds are being removed from the chicken house. In this mode:

- You can limit light intensity and ventilation
- The following functions are disabled.
 - Humidity/CO2/Ammonia treatment
 - Heating
 - Foggers
 - Water and feed
 - WOD
 - Nipple flushing
 - Feeders and drinkers control
- High/low temperature and high static pressure alarms are active. All other alarms are disabled.

To configure Catching Mode.

1. In Control > Control Mode, define House Mode as Catching.

2. If required, click  and set the parameters:

- Light Intensity: Default 0%, range 0-100%
- Temp & Pressure Alarms Enable: Define as Yes or No.
- Level of Ventilation: 0 means ventilation works automatically. 1 – 30 sets the ventilation mode.

3.14 System Parameters

System Parameters consolidates all the **HELP | SET** menus into one scroll screen.

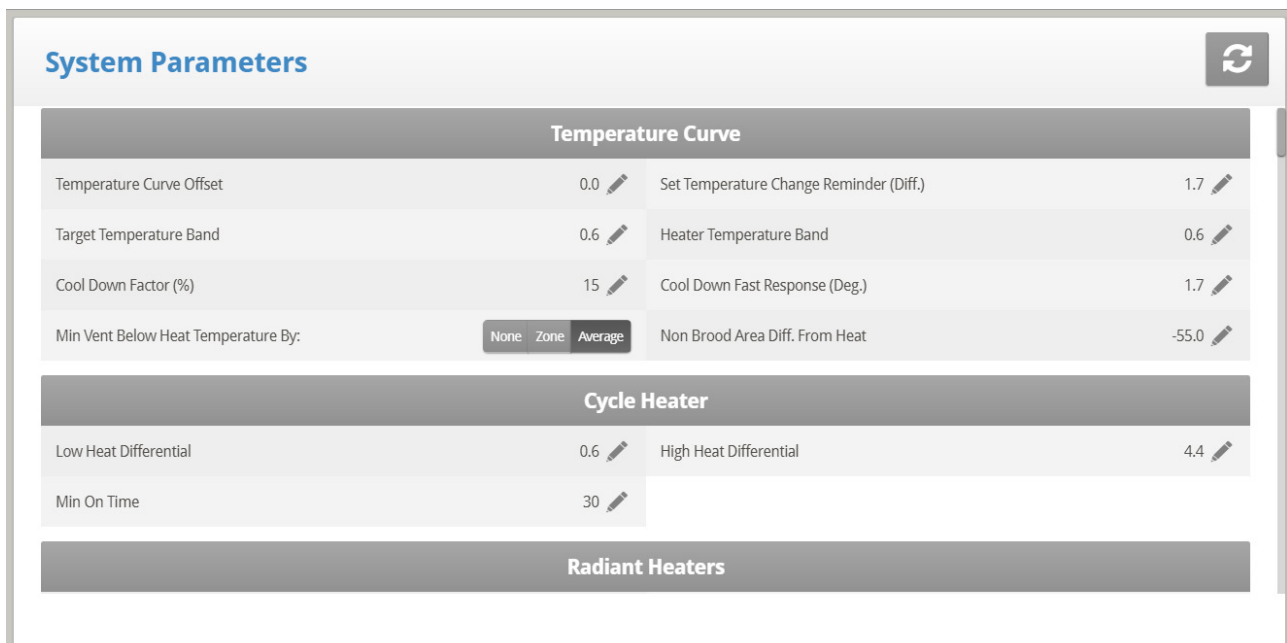

The screenshot shows the 'System Parameters' interface. It features a title bar with a refresh icon. The main content is organized into three sections: 'Temperature Curve', 'Cycle Heater', and 'Radiant Heaters'. Each section contains a list of parameters with their current values and edit icons.

Temperature Curve			
Temperature Curve Offset	0.0	Set Temperature Change Reminder (Diff.)	1.7
Target Temperature Band	0.6	Heater Temperature Band	0.6
Cool Down Factor (%)	15	Cool Down Fast Response (Deg.)	1.7
Min Vent Below Heat Temperature By:	<input type="radio"/> None <input type="radio"/> Zone <input checked="" type="radio"/> Average	Non Brood Area Diff. From Heat	-55.0

Cycle Heater			
Low Heat Differential	0.6	High Heat Differential	4.4
Min On Time	30		

Radiant Heaters			
-----------------	--	--	--

3.15 Ammonia Treatment

Ammonia treatment forces an increase in ventilation level when the ammonia level is too high. To prevent fans changing their ventilation too often, treatment begins after a user-defined delay.

If during treatment, the ammonia level drops below the **Stop Value** parameter, the ventilation level automatically returns to that level used before ammonia treatment began.

3.15.1 AMMONIA TREATMENT MAIN SCREEN

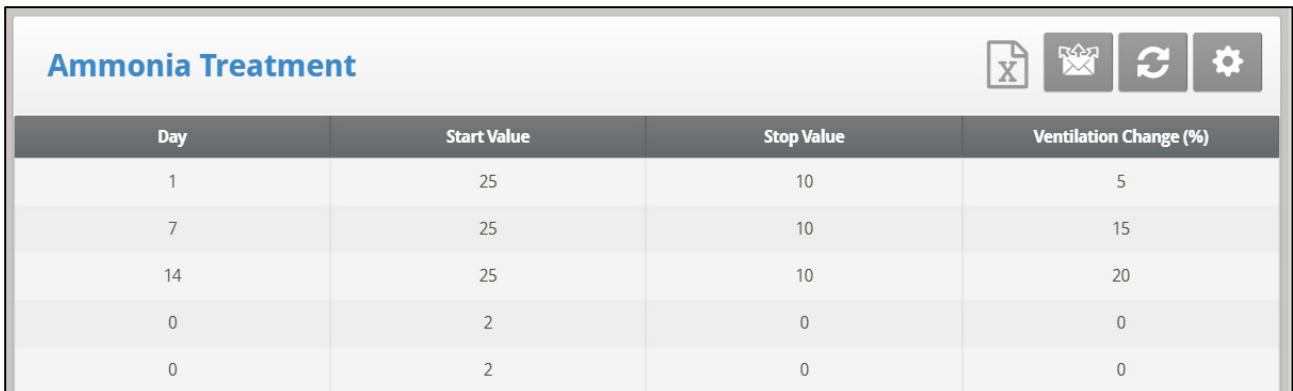

Day	Start Value	Stop Value	Ventilation Change (%)
1	25	10	5
7	25	10	15
14	25	10	20
0	2	0	0
0	2	0	0

➤ This function requires an ammonia sensor.

1. In *System > Analog Sensors* (refer to Analog Sensors), designate one sensor as an ammonia sensor.
2. **On the keyboard:** If required, go to *Service > Ammonia* and calibrate the sensors (refer to Ammonia Calibration).
3. In *Control > Ammonia Treatment* set the parameters.
 - **Day:** Growth day. You can set multiple programs for same day (maximum number of programs: 20)
 - **Start Value:** Ammonia value at which to begin treatment. Range: 0 to 100. Default: 2

NOTE: Ammonia levels should not be higher than 30 ppm.

- **Stop Value:** Ammonia value at which to end treatment. Range: 0 to 100. Default: 2. The stop value must be lower than the start value.
 - **Ventilation Change (%):** Percentage increase in ventilation
4. Set the Ammonia Alarm (page 60).

3.15.2 AMMONIA TREATMENT HELP | SET DEFINITIONS

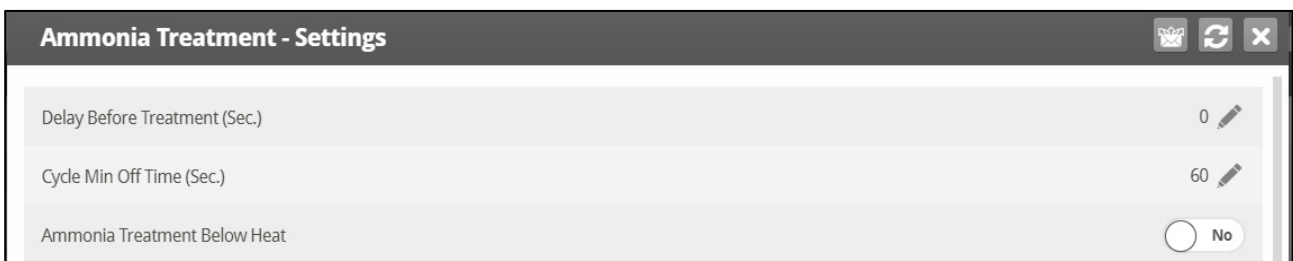

Setting	Value
Delay Before Treatment (Sec.)	0
Cycle Min Off Time (Sec.)	60
Ammonia Treatment Below Heat	No

- **Delay Before Treatment (sec):** Number of seconds the controller pauses before ventilating

- **Cycle Minimum OFF Time (sec):** The minimum amount of time that the fans do not operate during a cycle.
- **Ammonia Treatment below Heat:** Select YES or NO to enable CO2 treatment when heaters are operating (set in Temperature Curve).

3.16 Feed Scale Program

NOTE Broiler Mode supports this function

Feed Scale enables mixing different types of feeds from (up to) four different feed bins. The user fills each bin with the required feed type and sets the mixture ratios and quantities in Platinum. The augers then distribute the feed as defined.

This screen defines:

- the total quantity of feed to be delivered to the birds
 - the auger feed mixture.
1. In *System > Relay Layout* (page 90), define relays as augers as required.
 2. In *Management > Bird Inventory* (page 54), enter the number of birds.
 3. Go to *Control > Feed Scale Program*.

Feed Scale Program						
Day	Feed Per Bird	Silo (%)				Total Feed
		1	2	3	4	
1	0.200	70	10	10	10	6,367
5	0.300	60	20	10	10	9,551
12	0.400	100	0	0	0	12,734
0	0.000	0	0	0	0	0

4. Define:

- **Day:** Define the days at which the feed per bird changes. Platinum Touch / Rotem One calculates a feed curve based on these days. You can define the days as negative days.
- **Feed per Bird:** Define the amount of feed per bird/pigs (kilograms) to be distributed. Platinum calculates the total amount of feed to be distributed based on this parameter and the Bird Inventory parameters.
- **Silo (%):** If there is more than one silo supplying feed, enter the percentage of the feed package that each silo supplies. Note that by default, Silo 1 supplies 100% of the feed. Any number entered in Silo 2, 3, or 4 is subtracted from Silo 1.
- **Total Feed:** Displays the amount of feed required for that day. This amount is calculated by multiplying the feed per bird by the number of birds in the bird inventory (taking into account any birds culled, died, or moved).
- **Today:** These numbers display the actual amount of feed required for the current growth day. In the example shown above, the growth day is Day 2. Platinum Touch / Rotem One calculates the curve from Day 1 to Day 5 and adjusts the numbers accordingly.

3.16.1 FEED SCALE HELP | SET DEFINITIONS



Feed Scale Setting	
Time [hh:mm]	00:00
Max Portion Weight	25
Max Auger Time (Min)	10
Not Empty Time (Min)	60
Stop Diff. 1 Weight	2.0
Stop Diff. 2 Weight	2.0
Stop Diff. 3 Weight	2.0

- **Define:**
 - **Time:** What time the hopper begins distributing feed to the birds or animals.
 - **Maximum Portion Weight:** Enter the feed scale container size.
 - **Maximum Auger Time [minutes]:** This parameter sets an alarm for the auger running time. Enter the number of minutes that the auger can run, after which an alarm appears on the Main Screen.
 - **Not Empty Time [minutes]:** This parameter sets an alarm for the feed container. The container should distribute all its feed to the feed lines. If feed remains in the container, it could mean that there is a problem (for example, the valve doesn't open). Set the amount of time that feed can remain in the container, after which an alarm appears on the Main Screen.
 - **Stop Differential 1/2/3/4 Weight:** After each silo stops supplying feed to its auger line, a certain amount of feed continues to flow. This differential compensates for this excess and ensures that only the required amount gets to the feeding container. Enter the approximate amount of feed that can be found in the augers. The number does not need to be exact. In the following feed runs, Platinum will correct the amount entered.
 - **Optimizer:** This parameter sets the unit's sensitivity to signal noise (caused by a variety of factors). The sensitivity plays a role as the controller stabilizes itself. Greater amounts of noise require faster optimization. To view an indication of the controller's stability, go to *Scale Menu > Test* (refer to page 61) and perform a test. If the number remains stable, slower optimization is indicated. There are three settings: Default, Slower, Faster.

NOTE Munters recommends leaving this parameter at the default level.

- **Valve Close Time [seconds]:** Set the delay in time, if any, that the valve emptying the feed scale closes.
- **Feed Tare [A/D count]:** This specification is used for certain tests performed by a certified technician.

NOTE Munters recommends leaving this parameter unedited.

- **Operating Mode:** See following section.

3.16.2 OPERATING MODE

Operating Mode (Version 7.22) enables:

- Stopping and resuming feeding
- Initiating a feeding at any given time.

The parameter has three modes:

- Auto: Feeding operates according to the programming (default).
- Bypass: Feeding continues even if there is a problem with valves or scales. Valves remain open and augers continue to operate until the bypass state ends. During Bypass containers are filled by time (X kilos or pounds/minute).
- Stop: All feeding and feeding equipment stops.

To use the Bypass Mode:

1. From the drop-down list, select Bypass.

2. Define:

- Feed Rate Update Mode:
 - Auto: The controller uses the existing parameters to determine the feed rate. Note that if the user enters numbers in the Feed Rate Parameters, the controller will override these parameters if there is a contradiction between them and the existing parameters.
 - Manual: The user enters the feed rate in the parameters below.
- Feed Rate 1 – 4: Enter the amount of feed (kilograms or pounds) to be distributed by each auger per minute.

NOTE If a [hopper sensor](#) is installed, feed flow stops if there is an overflow alarm.

3.16.3 FEED SCALE HOT SCREEN

Press "Right and Up Arrows" to view the Feed Scale Hot Screen.

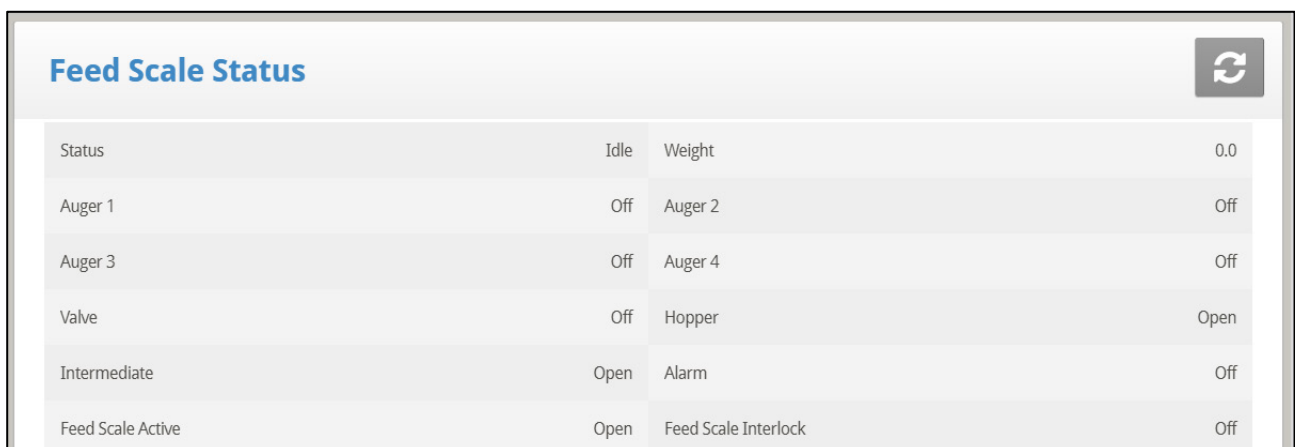

Feed Scale Status				
Status	Idle	Weight	0.0	
Auger 1	Off	Auger 2	Off	
Auger 3	Off	Auger 4	Off	
Valve	Off	Hopper	Open	
Intermediate	Open	Alarm	Off	
Feed Scale Active	Open	Feed Scale Interlock	Off	

This screen shows the status of different areas of the feeding apparatus. illustrates the system components.

- Define:
 - **Status:** Shows the feed scale status: Idle, Emptying, or Filling.
 - **Weight:** Shows the feed scale container weight
 - **Auger 1/2/3/4:** Shows if the auger is running or off
 - **Valve:** Shows if the valve emptying the feed scale is open

- **Feed S. Active:** This field shows which controller is managing the feed scale.
- **Feed S. Interlock:** The Feed Scale Interlock is a digital sensor which detects which damper is active.
- **Hopper:** The hopper is a digital sensor which detects if the feed has reached the maximum level in the feed bin. Define this sensor in System > Digital Sensor. This screen shows the sensor's current status. If the feed reaches the maximum amount, an alarm is triggered.
- **Intermediate:** The intermediate sensor is a digital sensor which detects if the feed has reached the maximum level in the feed bin. Define this sensor in System > Digital Sensor. This screen shows the sensor's current status.
- **Alarm:** This parameter shows if there are active alarms. View the alarms on the Main Screen.

3.16.4 FEED SCALE FUNCTIONALITY IN TWO HOUSES

Platinum Touch / Rotem One enables sharing feed scale functionality between two houses. Two load cells are connected to a single feed scale. Each Platinum Touch / Rotem One Controller is connected to one load cell.

When the system is running, one controller operates each set of augers, feed scale valve, hoppers, and so on. A mechanical damper switches the feed supply from the scale to the corresponding hopper. Only one feed process operates at a time; when one process is running the second is in standby.

- Each hopper auger is managed by a separate feed sensor, installed in the last dish in the last feed line in each house.
- Both Platinum Touch / Rotem One units are connected to a single feed scale container.
- Contactors connected to the silo augers determine which house is active.
- Each Platinum Touch / Rotem One controller is connected to a separate hopper sensor, which indicates when the hopper is filled.
- Important: Each Platinum Touch / Rotem One Controller transmits the Feed Scale State to the second controller, via the Feed Scale Active Relay. This relay prevents a controller from assuming control of the Feed Scale when the latter is active. Controller 1 will release control if:
 - The hopper sensor shows the hopper to be filled
 - The feed cycle is complete.
 - In addition, if an Auger Overtime alarm is generated, control is transferred to the other Platinum.
- Hot key (see Feed Scale Hot Screen)

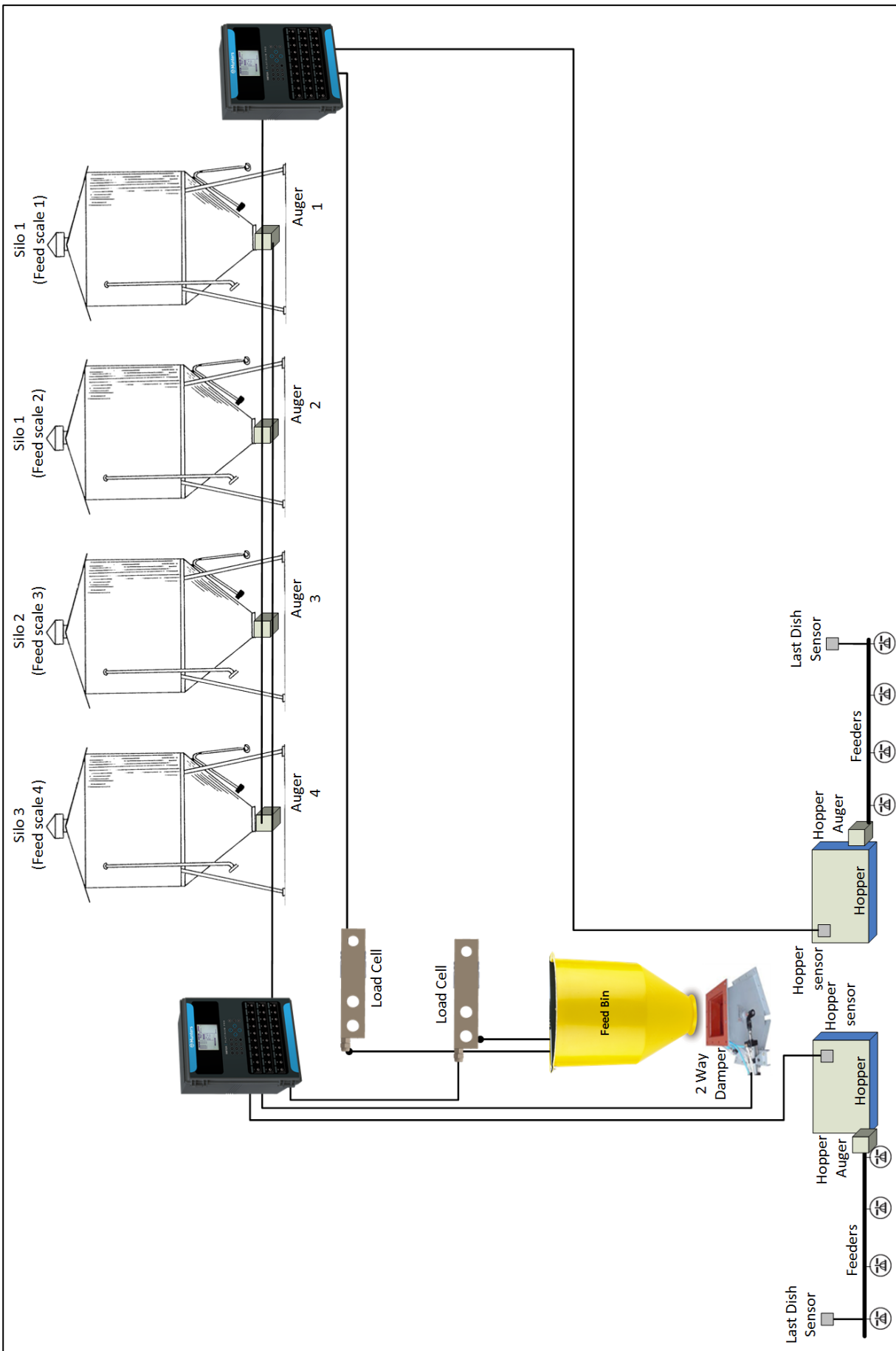



Figure 6: Feed scale block diagram

To set up the Feed Scales:

➔ Refer to the Installation manual on wiring the Controllers to the Feed Scale and Load Cells.



1. Go to *System > Relay Layout*.
2. Define a relay as Feed S. Active.

Relay Layout  

Relay No.	Device	No.	N.C.
↳ Card 2 Main Slot 2			
11	Feeder	1	<input type="checkbox"/>
12	Auger	1	<input type="checkbox"/>
13	Feed Line Up	1	<input type="checkbox"/>
14	Feed Line Down	1	<input type="checkbox"/>
15	Drink Line Up	1	<input type="checkbox"/>
16	Drink Line Down	1	<input type="checkbox"/>
17	As Analog Out	1	<input type="checkbox"/>
18	Feed Scale Active	1	<input type="checkbox"/>
19	Auger	2	<input type="checkbox"/>
20	Curtain Open	1	<input type="checkbox"/>
▶ Card 3 Main Slot 3			

3. Go to *System > Digital Sensor*.

4. Define one sensor as Hopper Sensor and one sensor as Feed Scale Interlock.

Sensors  

Analog
Digital

Output No.	Function	Sensor No.
↳ Card 1 Main Slot 1		
1	Water Meter	1
2	Feed Count	1
3	Low Water S.Pressure	1
4	Hopper	1
5	Intermediate	1
6	Feed Scale Interlock	1
7	None	0
8	None	0
9	None	0

3.17 Light Dimmers

Platinum Touch/Rotem One supports configuring up to five RLED 2.0 Light Dimmers from the Platinum Touch/Rotem One screen. RLED 2.0 can be connected via a Platinum Touch/Rotem One communication card or via an analog output card. Each RLED 2.0 has two independent channels; meaning five RLED 2.0 units fulfill the role of ten light channels.

NOTE Verify that UI Server Version/Client Version is 3.2.1 or higher. Update the software if required.

- ➔ Install the units before attempting to configure the RLED 2.0s. Light Dimmers only appear in the Installation Menu if RLED 2.0s are connected to the controller. Refer to the RLED 2.0 Installation Manual for details.

NOTE In the following screens, if an RLED 2.0 is connected to an analog output card, ~ appears next to the light line (for example: ~Light 6).

1. On the keyboard: Go to *Test > Hardware Checklist* and verify that RLED appears and that the status is OK.

HARDWARE CHECKLIST				
Card	Box	Slot	Status	Chann.
Alarm 1				1
Relays				40
N.O. 1	1	1	OK	10
N.O. 2	1	2	OK	10
N.O. 3	1	3	OK	10
N.O. 4	1	4	OK	10
RDT5				0
RLED				4
RLED 1	4	2	OK	2
RLED 2	4	3	OK	2
RLED 3	4	4	OK	2
RLED 4	4	5	OK	2
RLED 5	4	6	OK	2

- If the status is not OK, recheck the wiring.
- If an RLED 2.0 is connected to an analog output card
 - The RLED 2.0 appears under Analog Output.
 - The channel address is 0.

2. Go to *System > Light Dimmers*.

3. On each line and channel (for example ADD-1, CH-A), map a lighting line to an RLED 2.0 channel. In this example, there are five RLED 2.0s, controlling all 10 lighting lines.

Light Dimmers

Address	Device
ADD-1 CH-A	Light 1
ADD-1 CH-B	Light 2
ADD-2 CH-A	Light 7
ADD-2 CH-B	None
ADD-3 CH-A	None
ADD-3 CH-B	None
ADD-4 CH-A	None
ADD-4 CH-B	None
ADD-5 CH-A	None
ADD-5 CH-B	None

- You can map the channels to the light lines in any order.

4. Go to *Control > Light*.

Light Control

Light Feed
Light No Feed

Day	Time	Light Dimmer		
		1	2	7
1	00:00	15	15	20
0	00:00	0	0	0
0	00:00	0	0	0
0	00:00	0	0	0
0	00:00	0	0	0
0	00:00	0	0	0
0	00:00	0	0	0
0	00:00	0	0	0

5. Define the parameters as described Light, page 35.

6. The main screen now displays the active and inactive light lines.

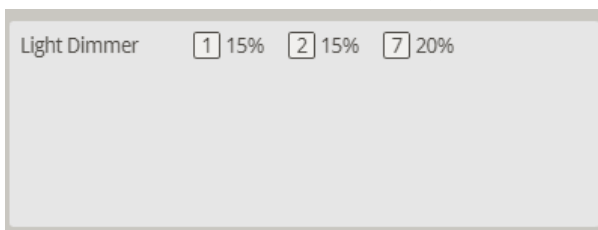

3.18 Water Dosing

Platinum Touch/Rotem One Version 7.20 supports specific dosing pumps used to inject additives into the water supply. From the controllers you can define the type of pump used, the additive, dosage rate, and additive amount.

➔ Install and map one pump to a digital input screen.

- Water Dosing Main Screen
- Water Dosing Help | Set Definitions

3.18.1 WATER DOSING MAIN SCREEN

NOTE Version 7.20 supports one pump. Version 7.22 supports up to four pumps. All pumps use the same additive and dosage rate.

1. In Install > Digital Sensor, select Pump Cycle Meter (one).
2. In Install > Digital Sensor, select Pump Additive Over (optional).
3. Repeat for each set of sensors (Version 7.22)
4. Go to Control > Water Dosing.

The screenshot displays the 'Dosing Pump Settings' interface. At the top, a status bar shows the time (22:31), day (Day 1), and house status (Full House). There are also icons for a home button, a menu, a red 'On' indicator, a mail icon with a '4' notification, and a settings icon. The main content area is titled 'Dosing Pump Settings' and contains two pump configuration sections: 'Pump 1' and 'Pump 2'. Each section has a header bar with the pump name. Below each header, there are three rows of settings: 'Pump Name' (with status), 'Pump Type' (with a dropdown menu), 'Additive Name' (with a dropdown menu), 'Dosage Rate %' (with a text input), and 'Additive Amount' (with a text input and a pencil icon for editing). Pump 1 is 'Connected' and has a '0.8 Fixed' pump type, 'None' additive name, and a dosage rate of 0.8. Pump 2 is 'NOT Connected' and has the same settings as Pump 1.

Pump 1	
Pump 1	Connected
Pump Type	0.8 Fixed
Additive Name	None
Dosage Rate %	0.8
Additive Amount	0

Pump 2	
Pump 2	NOT Connected
Pump Type	0.8 Fixed
Additive Name	None
Dosage Rate %	0.8
Additive Amount	0

5. Define:

- Pump 1-4: This is a read only field which displays the pumps status.
- Pump Type: Select the type of pump being used.
 - 0.8 Fixed: This pump provides a fixed dosage rate (0.8%).
 - 0.3 – 2 Variable: This pump provides a variable rate between 0.3 to 2.5%.
- Additive Name: Select an option.

- Dosage Rate: If you defined the pump type as variable, define the dosage rate. Default: 0.8%
 - The dosage volume per pulse is 400 cc (water and additive). The dosage volume of the additive is 400 x the rate. For example 400 x 0.8 = 3.2 cc.
- Additive Amount: Define the number of liters of additive.

3.18.2 WATER DOSING HELP | SET DEFINITIONS





The screenshot shows a window titled "Dosing" with a dark header bar. In the top right corner of the header bar are three icons: a crown, a refresh symbol, and a close symbol. Below the header bar is a light gray area containing a single parameter: "Dosing Shortage Alarm Time sec" on the left and the value "20" on the right, followed by a small pencil icon indicating it is editable.

- Dosing Shortage Alarm Time (sec): Define the amount of time that must pass when additives cease to be added before an alarm is triggered. Range: 1 – 9999 seconds. 0 disables the alarm. Default: 20.

4 Management Menu

The following sections detail the Management Menu.

 Control	Bird Inventory	Feeders & Drinkers
 Management	Feed Inventory	Nipple Flushing
 History	Growth Day & Flock	Water On Demand
 System	Alarm Settings	Current Sense
	Alarm Reset	RDT-5 / Temp. Curve
	Fail Safe Settings	Switches & Relays
	Password	

- Bird Inventory
- Feed Inventory
- Growth Day and Flock
- Alarm Settings
- Alarm Reset
- Fail Safe Settings
- Password
- Feeders & Drinkers
- Nipple Flushing
- Water on Demand
- Current Sense
- RDT-5
- Switches and Relays

4.1 Bird Inventory

Maintain your inventory by entering data into the controller.

Bird Inventory								
	Birds Placed	Dead Birds		Culled Birds		Birds Moved		Bird Count
		Update	Total	Update	Total	Update	Total	
♂ Male	12,000	0	12	0	13	0	45	11,930
♀ Female	20,000	0	46	0	4	0	45	19,905
Total	32,000	0	58	0	17	0	90	31,835

1. Enter the quantities under Birds Placed. There are separate rows for male and female. If you do not wish to keep separate data, simply enter the data into one or the other.
2. When required, enter the quantity found dead, culled, or moved. Platinum Touch / Rotem One calculates the totals and subtotals.
3. You can correct an error, so long as you correct it on the same day before midnight. After midnight, the information transfers to the [Mortality_Menu](#).

4.2 Feed Inventory

- Feed Inventory Main Screen
- Feed Inventory Help | Set Definitions

4.2.1 FEED INVENTORY MAIN SCREEN

Maintain your feed inventory by entering data into the controller.

Feed Inventory				
Date	Silo			
	1	2	3	4
22-Sep-19	630	681	681	454
--	0	0	0	0
--	0	0	0	0
--	0	0	0	0
--	0	0	0	0
--	0	0	0	0
--	0	0	0	0
--	0	0	0	0
Total Feed	630	681	681	454
Active	<input checked="" type="checkbox"/>	<input type="checkbox"/>	<input type="checkbox"/>	<input type="checkbox"/>

To enter feed inventory manually:

1. Enter the date.
2. Enter the feed quantity under the silo and press **ENTER**. The cumulative total appears in the Total Feed row.
3. If required, click  and set the parameters.
4. Set the [Feed Alarms](#).

If you have installed load cells and connected silo scales to your Platinum Touch, it automatically maintains feed inventory, including delivery dates and feed consumption data. You can monitor your fill system and maintain approximate feed inventory using the [Digital Inputs](#). In this case, you need to enter your own delivery dates.

This information transfers to the History > [Water](#) and [Feed](#) menus daily, or optionally as often as selected (by the minute) in [History View](#).

4.2.2 FEED INVENTORY HELP | SET DEFINITIONS

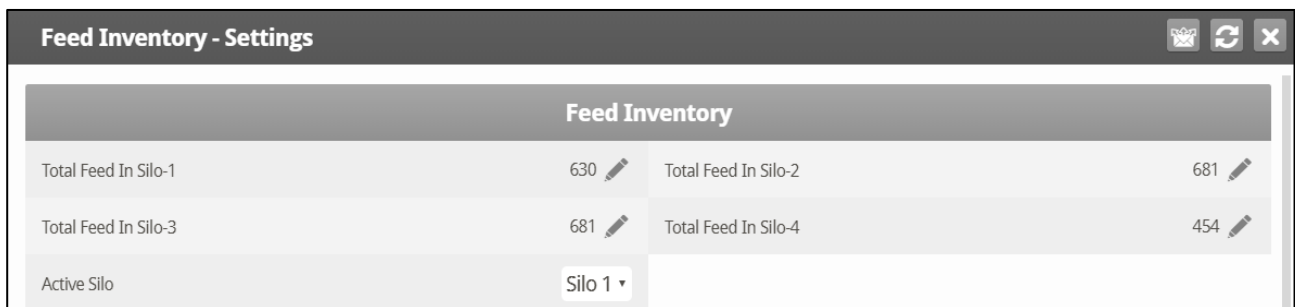

Feed Inventory			
Total Feed In Silo-1	630	Total Feed In Silo-2	681
Total Feed In Silo-3	681	Total Feed In Silo-4	454
Active Silo	Silo 1		

- **Define:**
 - **Total Feed in Silo-1/ -2/ -3/ -4:** Manually change or correct the amount of feed in the silos.
 - **Active Silo:** Select the required silo for use. It is possible to select all of them.

4.3 Growth Day and Flock

This menu defines the number of growth days and flock number.

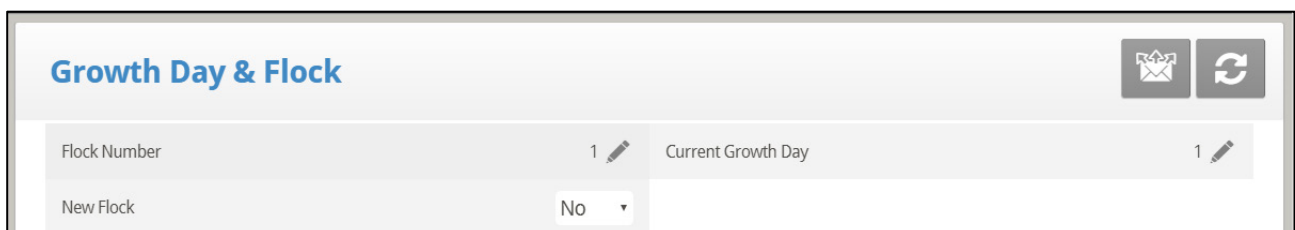

Flock Number	1	Current Growth Day	1
New Flock	No		

- **Define:**
 - **Flock Number:** The controller automatically increments the group/flock number each time you choose New Flock/Group. You can edit the flock number. Since this field accepts six digits, some producers enter a flock number that is made of the day, month and year the birds arrived.
 - **Current Growth Day:** Enter current growth day, if necessary. It is possible to enter negative growth days up to -2. If you reset the growth day for a new

flock using this tool, your old history data does not clear. Use New Flock/Group function to clear out old history in preparation for new birds.

- **New Flock:** Use the new flock function on arrival of a new set of birds to set the growth day back to 1, 0, -1, or -2, and to clear out old history data.

4.4 Alarm Settings

This menu defines the various alarm settings.

The screenshot shows the 'Alarm Settings' configuration screen. At the top right, there are three icons: a mail icon, a refresh icon, and a settings icon. The settings are organized into sections:

- Global Alarm Delay (Sec.):** 60
- "Alarm Reminder (Minutes, 0-Disable)":** 30
- Sensor Alarm**
 - Sensor Low Temperature Range:** 0.0
 - Sensor High Temperature Range:** 50.0
 - Sensor Alarm-Differential From Low Alarm:** 0.6
 - Sensor Alarm-Differential From High Alarm:** 0.6
- Alarm**
 - Alarm Test At Time: (hh:mm):** 12:00
 - Day Of Alarm Test:** Daily
 - Alarm Test Duration (Sec.):** 0
- Auger Overtime Alarm**
 - Auger Overtime Delay (Min.):** 15
 - Auger Off During Overtime:** No

NOTE See [Fail Safe Setting](#).

- **Define:**
 - **Global Alarm Delay (second):** Alarms without a separate alarm delay, use this global delay before signaling the alarm.
 - **Alarm Reminder (minutes, 0-Disable):** Amount of time before a reminder is sent if the situation has not yet been corrected.

Sensor Alarm

- **Sensor Low Temperature Range:** Sets the minimum reading a sensor can have to be considered a valid sensor reading. Sensor readings below this point are rejected. This generates a sensor out of range alarm. This does not apply to the special Circuit Breaker Sensor or Outside Temperature Sensor.
- **Sensor High Temperature Range:** Sets the maximum reading a sensor may have to be considered a valid sensor reading. Sensor readings above this point are rejected. This generates a sensor out of range alarm. This does not apply to the special Circuit Breaker Sensor or Outside Temperature Sensor.
- **Sensor Alarm-Differential from Low Alarm:** Individual sensor (or zone) alarm if any active sensor reads this much or more below the Control > Temperature Curve >Low Alarm Temperature.

- **Sensor Alarm- Differential from High Alarm:** Individual active growth area sensors alarm if they read this much or more above the Control > Temperature Curve >Low Alarm Temperature.

Alarms

- **Alarm Test at Time (hh:mm):** Schedule the alarm test time.
- **Day of Alarm Test:** Choose **Daily** or a particular **day** of the week for the scheduled alarm.
- **Alarm Test Duration (seconds):** Enter the alarm test duration.

Auger Overtime Alarm

- **Auger Overtime Delay (minute):** Set the maximum auger run time for your cross-fill system. If you have a monitor connected to the digital inputs programmed as Feeder-1 Overtime or Feeder-2 Overtime the Platinum Touch / Rotem One sends an alarm after this delay.
- **Feeder Off During Overtime:** Choose whether to shut the feed systems off after a feeder overtime alarm. Options:
 - No: All augers and feeders remain on.
 - YES: All augers and feeders shut down.

*NOTE If you choose **All** or **Related**, the feed system turns off and does not resume until you select [Reset Alarm](#) in the Management Menu.*

Feeder Overtime Alarm

- **Feeder Overtime Delay:** Set the maximum feeder run time for your cross-fill system. If you have a monitor connected to the digital inputs programmed as Feeder-1 Overtime or Feeder-2 Overtime the controller sends an alarm after this delay.
- **Feeder Off During Overtime:** Choose whether to shut the feed systems off after a feeder overtime alarm. Options:
 - No: All augers and feeders remain on
 - All: All augers and feeders shut down.
 - Related: Only the specific auger from which the alarm originated and its feeders shut down.

NOTE This alarm functions in the Broiler mode only.

NOTE Setting the Feeder Off During Overtime to All in either the Auger Overtime Alarm or the Feeder Overtime Alarm shuts down the augers and feeders, regardless of the other alarm's setting.

Auger Empty Alarm

- **Condition Detection Delay (sec.):** Platinum Touch / Rotem One sends an alarm when the current goes to the level set in the following parameter after this delay.
- **Below Nominal Current (%):** Send an alarm when the nominal current drops to this level.

➤ This alarm is operative only if 1) Current Sense Relays are installed and calibrated 2) augers have been calibrated.

4.4.1 ALARM SETTING HELP | SET DEFINITIONS

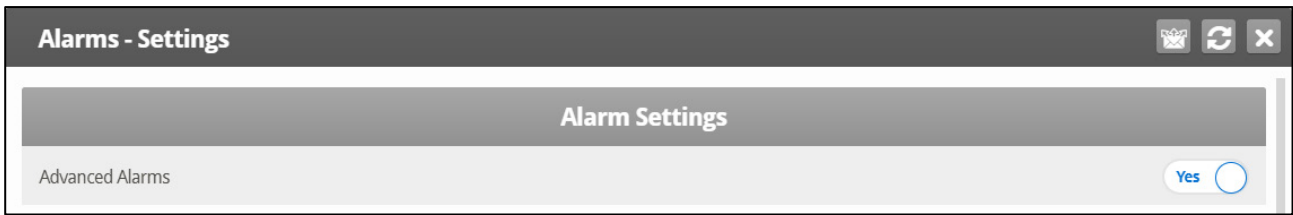

- **Define:**

- **Advanced Alarms:** When selecting YES, the following additional alarms appear on the ALARM SETTINGS screen (press MENU and then ENTER to reenter the screen).

Water on Demand Alarms

- **High/Low Pressure Diff (PSI):** Sends an alarm when the difference between the current WOD pressure and the defined pressure reaches these levels. 0 means that the alarm is disabled.
- **Shutdown Pressure Diff (PSI):** Shuts down the Water on Demand system when the pressure reaches this level.
 - Shutdown pressure must be equal to or higher than the High/Low Pressure Difference.
 - However, to disable this alarm set it to 0 (zero), even if the High/Low Pressure is above 0.

Feed Alarms

- **Allow Feed Alarm From/To (hh:mm):** Set a starting time from which the controller can send feed shortage alarms.
- **Low Feed Alarm Limit:** Alarm if feed in Silo 1/2/3/4 is below this limit and time is within the From and To limits.
- **Feed Alarm Limit (per hour):** An alarm is generated if the feed flow is greater than this amount. This alarm is activated when a problem arises inside the barn (as opposed to when something happens to the feed scale).

Water Overflow Alarms

- **Overflow According to Light Table:** Change overflow alarm level when the lights are off.
- **First Day Curve for Overflow:** Overflow on the FIRST day applies to the first day operation. You can define a first day at which to start increasing the overflow limit automatically. Days prior to the 'First Day' use the First Day overflow limit; days following the first day have an incremental curve toward the LAST DAY OVERFLOW parameter setting.
- **Overflow on First Day (per minute):** Number of gallons/liters per minute that generates an overflow alarm on the first day.
- **Last Day Curve for Overflow:** Set the maximum overflow limit (gallons/liters) for those days following the last curve day.
- **Overflow on Last Day (per minute):** Number of gallons/liters per minute that generate an overflow alarm on the last day.

- **Overflow At Dark** (per minute): Select overflow limit. When it is dark, the controller checks every minute.
- **Overflow Alarm Delay** (minute): Define delay time before the controller generates an overflow alarm.
- **Extra Delay At Light Start** (minute): When the first light appears, define the amount of minutes before the controller begins to operate according to the set Overflow for that day.
- **Fogger Water Overflow** (per minute): Define the water overflow for foggers (gallons/liter per minute).
- **Water Off During Overflow**: Choose whether to shut the water off after a water overflow alarm. Options:
 - No: Water lines remain on
 - Yes: When a water meter sends an alarm, the corresponding water line turns off.

Water Shortage Alarms

- **Allow Water Shortage Alarm From/To**: Set the period for which the controller generates water shortage alarms.

NOTE In Version 7.23, Water Shortage Alarms are only sent during the times when the water lines are operating. Water operation times are defined in Water & Feed, page 32.

- **Shortage During Lights Off**: Select whether water shortage alarm is disabled when all lights are out.
- **Quantity for Shortage** (Per min): Minimum flow rate that must be maintained or a water shortage alarm is generated.
- **Shortage Alarm Delay** (minutes): Minimum period of time that the shortage must extend through before generating an alarm.
- **Shortage Start Day**: Define on what day shortage alarms begin. This parameter prevents false alarms caused by young birds' low water usage. Default: 0 (meaning alarms function normally throughout the growth cycle).

Bird Scales Alarms

- **Allow Bird Scale Alarms From/To**: Set time frame for which the controller begins and ends generating alarms for the bird scale.

Auxiliary Alarms

- Assign auxiliary alarms in the Install menu. Note that digital sensors, auxiliary alarm input with related relay must always match their relay status.
 - **Related Relay For Aux Alarm 1/2/3/4**: Relay for Auxiliary Alarm 1/2/3/4.
 - **Auxiliary Alarm Delay (sec)**: Separate from the Global Alarm Delay. If there is a dry contact, the alarm is sent after the defined AUX. Alarm Delay.
 - **Aux Alarm D.I. Contact**: Alarm contacts can operate in Normally Open or Normally Closed format. **Normally Open** relays close where energy is applied; if current is interrupted, the relay opens and an alarm is sent. **Normally Closed** relays open when voltage is applied; when current is interrupted the relay closes and an alarm is sent. By default, Auxiliary Alarms are defined as NO.

Circuit Breaker Alarm

- **Temperature for Circuit Breaker Alarm:** Set circuit breaker alarm temperature.

CO2 Sensor Alarm

- **CO2 High Level:** Set the maximum allowed CO2 level above which an alarm is sent. The alarm ceases when the CO2 drops below this level. If the user acknowledges the alarm, the alarm messages temporarily cease (for the reminder time).

Humidity Sensor Alarm

- **Humidity High Level Alarm:** Set the maximum allowed humidity level above which an alarm is sent. The alarm ceases when the humidity drops below this level. If the user acknowledges the alarm, the alarm messages temporarily cease (for the reminder time).

Ammonia Alarm

- **Ammonia High Level:** Set the ammonia level at which an alarm is sent.

Secondary Alarms

- **Enable Secondary Alarms:** Refer to Prioritizing Alarms, page 61.

Potentiometer Alarm

- Enable potentiometer alarms, which send an alarm when vent/curtain potentiometer-controlled devices fail. To enable, set the time frame. If the from/to times are set to 0:00 (default) the alarm is disabled.

Low Light Intensity Alarm

- **Low Light Alarm Enabled:** Alarm sent when the measured light is less than 50% of the requested LUX target.
 - Version 7.20 supports this alarm. It is active only when a LUX sensor is installed and the alarm is enabled. In addition, the dimmer output value must be set to maximum output for the corresponding active light program line.

Auger Under Runtime

- **Auger Under Runtime (hours):** Define augers as required. Define a digital sensor as Auger Overtime Sensor. If the alarm contactor does not turn on within the time defined in this parameter, an alarm is generated.

4.4.2 PRIORITIZING ALARMS

Platinum Touch / Rotem One enables prioritizing alarms. When enabled:

- ventilation-related alarms are defined as critical. The main alarm relay will transmit these alarms to the device wired to the relay (for example, a dialer).
- non-ventilation alarms are defined as non-critical. A secondary relay will transmit alarms to another device (for example, an ELS).

To prioritize alarms:

1. Go to System > Relay Layout.
2. Define a relay as Alarm (N.C.).
3. Go to Manage > Alarm Setting > Help
4. Enable Advanced Alarms.
5. Go to Manage > Alarm Setting.
6. Scroll to Secondary Alarms and define as Yes.

4.5 Alarm Reset

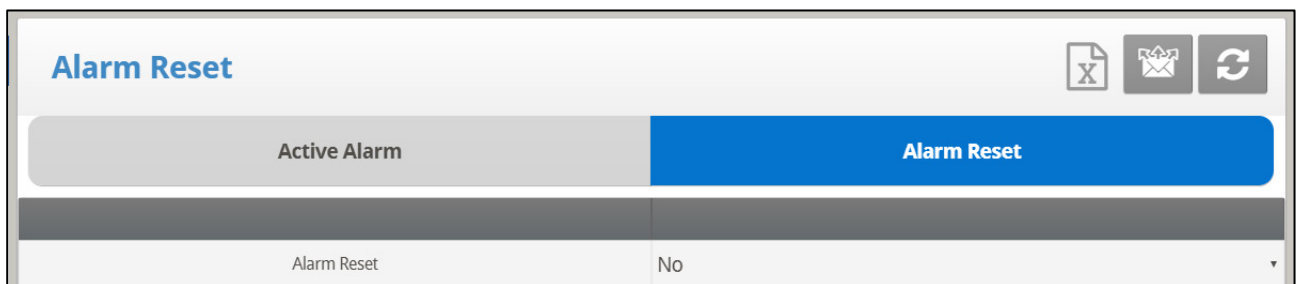

This menu functions as an alarm reset.

- **Alarm Reset:** Mark the box if you want to reset alarms. Enabling the reset:
 - Clears the alarm relay for all current alarms. The alarms may remain valid, but the unit does not register new alarms. If a new alarm occurs, or an existing alarm clears and reoccurs, the alarm relay signals again (after any appropriate delay).
 - Restores normal operation after an emergency pressure or feed overrun incident. If the controller experiences a high-pressure alarm for too long, it enters emergency pressure operation by opening all known air sources. Curtains open to preset amounts as set in Control > [Static Pressure](#). If you select SIREN ONLY, the alarm relay returns to the no alarm condition, but the emergency pressure status continues.
 - Restores normal operation after a feed overrun situation that calls for turning off the feeding system. If the feed monitor senses the cross auger runs too long, it trips a feed overrun alarm and optionally turns off the feed system. If you select SIREN ONLY, the alarm relay returns to the no alarm condition, but the feed overrun status continues.

4.6 Fail Safe Settings

When there is a problem such as extremely high air temperature, the Fail-Safe function immediately activates a backup system (for example the RBU-27) to ensure that adequate ventilation continues.

Setting	Value
High Temperature	No
Low Temperature	No
Low S.Pressure	No
High S.Pressure	No
Avg Temperature Fail	No
Auxiliary (Dry Contact)	No
High CO2	Yes

The Platinum Touch / Rotem One has six options besides controller failure or power off to activate the fail-safe relay.

- **High/Low Temperature:** Select to trigger fail-safe when the temperature is exceptionally high/low.
- **Low/High Static Pressure:** Select to trigger fail-safe when the static pressure is exceptionally low/high.
- **Avg. Temperature Fail:** Select to trigger fail-safe when all sensors in house fail.
- **Aux. (Dry Contact):** Select to trigger fail-safe when auxiliary dry contact occurs.
- **High CO2:** Select to activate fail-safe when the measured CO2 levels rise above permitted levels (Version 7.24 and above).

4.7 Password

Label	Password Field
Owner	User 1
User 2	User 3
User 4	User 5
Visitor	

- The users can access the controller and make changes to all controller settings and their own password. A user can only see and change the user's own password.
- The visitor can access the controller but cannot make changes. Each time someone accesses the controller with a password, an event is recorded in the [Events Log History](#).

NOTE If your controller uses passwords, the controller also requires a password entry to acknowledge switch position changes. If the switch change is not acknowledged the controller signals an alarm.

4.8 Feeders & Drinkers

- Feeders & Drinkers Main Screen
- Feeders & Drinkers Help | Set Definitions

4.8.1 FEEDERS & DRINKERS MAIN SCREEN

This selection enables inserting relevant information regarding feeder and drinker lines.

Feeders & Drinkers	
Day	Feeder-Line Lift
0	0.0
0	0.0
0	0.0
0	0.0
0	0.0
0	0.0
0	0.0



1. In *System > Relay Layout*, define at least one set of relays as Feed Line Up/Down or Drink Line Up/Down.

2. Define the following parameters:

- Day: Insert day number.
- Window Pos (%): Insert the percentage of window's position
- Feeder-Line Lift (inch): Define the specific feed line lift, measured in inches.
- Water-Line Lift (inch): Define the specific drinker line lift, measured in inches.

3. If required, click  and set the parameters.

4.8.2 FEEDERS & DRINKERS HELP | SET DEFINITIONS

Feeders & Drinkers - Settings	
Feeders & Drinkers	
Adjust At Time	12:00 
Feeder Window	
Stop Feed Before Adjust (Minutes)	60 
Time From Close To Open (Sec.)	15 
Feed Line	

- Define:

Feeders & Drinkers

- Adjust at Time: Set the required time to adjust the feeders' and drinkers' positions.

Feeder Window

- Stop Feed Before Adjust (Min): Set the amount of time to stop feeding before adjustment begins.
- Time from Close to Open (sec): Set the amount of time after stopping the feeding before opening the feeder's window.

Feed Line

- Movement Time per 10 inch (sec): Set the number of seconds needed to move the feed line 10 inches.

Drinkers Line

- Movement Time per 10 inch (sec): Set the number of seconds needed to move the water line 10 inches.

4.9 Nipple Flushing

1. Go to *System > Relay Layout*.

2. Define the relays as follows:

- Water Main: The control's supplementary for the usual water line
- Water Bypass: The control's supplementary to bypass the water pressure regulator
- Water line 1 through 122 Water line 10: Individual water line supplementary to select the line to flush

During normal operation, only relay 111 water main is active. During a flushing relay, code 112 is active together with each individual water line relay, each one running in turn.

4.9.1 SCHEDULING THE FLUSH

Nipple Flush		
Start Time	On Time (Min)	Status
00:00	0	Stop Auto Manual
00:00	0	Stop Auto Manual
00:00	0	Stop Auto Manual
00:00	0	Stop Auto Manual
00:00	0	Stop Auto Manual
00:00	0	Stop Auto Manual
00:00	0	Stop Auto Manual
00:00	0	Stop Auto Manual
00:00	0	Stop Auto Manual
00:00	0	Stop Auto Manual

1. Configure up to 20 flush times.
2. Set the water flushing start time and duration (water lines as defined by relay layout).

4.9.2 FLUSHING ORDER

	Sunday	Monday	Tuesday	Wednesday	Thursday	Friday	Saturday
Line	1	---	---	---	---	---	---
Order	1	---	---	---	---	---	---

- **Define:**
 - **Line:** Set flushing according to line/order.
 - **Order:** Set flushing per day.

4.9.3 NIPPLE FLUSHING BY TEMPERATURE

Version 7.20 supports nipple flushing by temperature, in which the flushing only takes place when the water temperature in the pipes reaches a certain temperature. This function requires one water temperature sensor per house:





- Water Temperature Sensor PTC:
 - 1V (4 mA) = -40° C
 - 5V (20 mA) = 60° C
- Munters Water Temperature Sensor

NOTE Refer to the Installation Manual for details on installing these products.

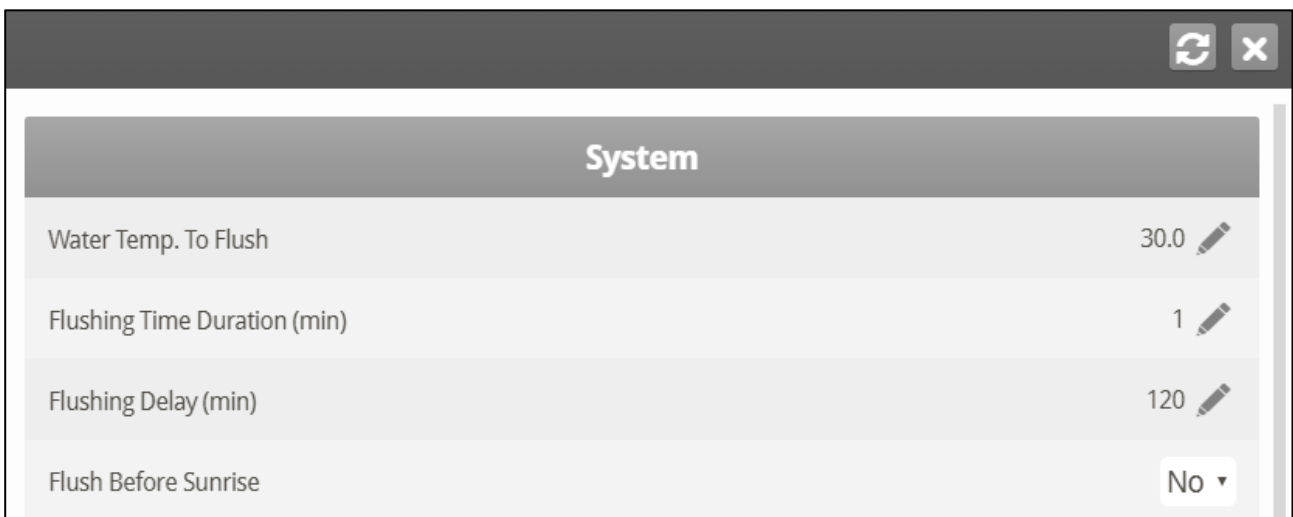
To configure nipple flushing by temperature:

1. In System > Sensor > Analog, define one sensor as Water Temp PTC and one sensor as Water Temp NTC.
2. In System > Relay Layout, define the required number of relays as Water Line.
3. Go to Service > Nipple Flushing and click  to set the parameters.



System	
Water Temp. To Flush	30.0 
Flushing Time Duration (min)	1 
Flushing Delay (min)	120 
Flush Before Sunrise	No 

4. Define:

- Water Temp to Flush: Water temperature at which flushing begins.
- Flushing Time Duration (min): Default 1 minute. Range: 0 - 250
- Flushing Delay (min): Default 120. Range: 1 - 999
- Flush Before Sunrise: Yes or No. Day is defined as when the light intensity reaches 70% of the intensity in the Light Table (refer to Light, page 35).

NOTE These parameters appear even if water temperature sensors are not installed, but in that situation they are irrelevant.

4.10 Water on Demand

The Water on Demand (WOD) function enables regulating the pressure of all nipple lines in the house from one central point, ensuring uniform pressure in all lines. The function also enables immediate transitioning between different preset pressures of all nipple lines in the house by closing and opening of valves at the central point (manual or solenoid according to the mode installed).

Platinum Touch/Rotem One enables controlling the water cycle times using relays and controlling the water pressure using analog input and output sensors. The two methods are complimentary. A user can use either one alone or both.

- Define at least one relay as Water on Demand.
 - Relay Control
 - Sensor Control
 - Water on Demand Help | Set Definitions

4.10.1 RELAY CONTROL

Specify up to 50 time periods.

Water On Demand				
Day	Time	Relays		
		1	2	3
1	08:00	<input checked="" type="checkbox"/>	<input type="checkbox"/>	<input type="checkbox"/>
5	08:00	<input checked="" type="checkbox"/>	<input checked="" type="checkbox"/>	<input type="checkbox"/>
10	06:00	<input checked="" type="checkbox"/>	<input type="checkbox"/>	<input type="checkbox"/>
0	00:00	<input type="checkbox"/>	<input type="checkbox"/>	<input type="checkbox"/>
0	00:00	<input type="checkbox"/>	<input type="checkbox"/>	<input type="checkbox"/>

1. In *System > Relay Layout* designate up to four relays as WOD valves.

2. In *Management > Water on Demand*, define:

- **Day:** Specifies the day to activate the selected WOD valve. You can define days as negative days.
- **Time:** Specifies the time to activate the enabled valves. The valves continue running until the next scheduled day and time. Specify up to 50 time periods.
- **Relays:** Enable the required relays.

3. Set the **WOD alarms**.

4.10.2 SENSOR CONTROL

Water On Demand						
Day	Time	Relays				Pressure
		1	2	3	4	
1	08:00	<input checked="" type="checkbox"/>	<input type="checkbox"/>	<input type="checkbox"/>	<input type="checkbox"/>	1.00
5	08:00	<input checked="" type="checkbox"/>	<input checked="" type="checkbox"/>	<input type="checkbox"/>	<input type="checkbox"/>	1.00
10	06:00	<input checked="" type="checkbox"/>	<input type="checkbox"/>	<input type="checkbox"/>	<input type="checkbox"/>	2.00
0	00:00	<input type="checkbox"/>	<input type="checkbox"/>	<input type="checkbox"/>	<input type="checkbox"/>	0.00
0	00:00	<input type="checkbox"/>	<input type="checkbox"/>	<input type="checkbox"/>	<input type="checkbox"/>	0.00
0	00:00	<input type="checkbox"/>	<input type="checkbox"/>	<input type="checkbox"/>	<input type="checkbox"/>	0.00
0	00:00	<input type="checkbox"/>	<input type="checkbox"/>	<input type="checkbox"/>	<input type="checkbox"/>	0.00

To add precision measurements:

1. In *System > Analog Output*:

- a. designate one output device as WOD.
- b. set the minimum input and output voltages.

2. In *System > Sensors > Analog*, designate one sensor as Water of Demand Pressure. This setting enables a sensor to measure the water flow.

3. In *Management > Water on Demand*, configure the following parameters:

- **Day:** Specifies the day to activate the selected WOD valve. You can define days as negative days.
- **Time:** Specifies the time to activate the enabled valves. The valves continue running until the next scheduled day and time.
- **Relays:** Enable the required relays.
- **Pressure:** Specifies the required water pressure. The unit that appears is the unit defined in System > [Setup](#) (pressure unit) (page [Setup](#)).

4. If required, click  and set the parameters.

5. Using the Keyboard: In Service > WOD Calibration:
- Enter the first pressure and voltage data points.
 - Repeat for second data point.

6. Set the WOD alarms in [Water on Demand Alarms](#).

4.10.3 WATER ON DEMAND HELP | SET DEFINITIONS

These parameters define the feed and water delivery schedule through the week.



The screenshot shows a software window titled "Water On Demand - Settings". It has a dark header bar with the title and three icons (help, refresh, close). Below the header, there are two settings rows. The first row is "Water Press. During Flush:" with a value of "0" and a pencil icon for editing. The second row is "Relay Active During Flush:" with a dropdown menu currently showing "None".

- Define:
 - **Water Pressure During Flush:** Designate the system water pressure when nipple flush is operative.
 - **Relay Active During Flush:** Designate which WOD relays remain active during flushing.

4.11 Current Sense

TBD

4.12 RDT-5

- Configuring the RDT-5
- RDT-5 / Temperature Curve | Set Definitions
- RDT-5 Digital Alarm
- Saving and Loading RDT-5 Tables
- RDT-5, Version 7.22

4.12.1 CONFIGURING THE RDT-5

- Munters' RDT-5 is a five-stage digital thermostat that works in conjunction with Platinum Touch/Rotem One Controllers or as a stand-alone unit. When wired to

the Platinum Touch/Rotem One, you can use the Platinum Touch/Rotem One to set the RDT-5's stage activation temperatures (which is easier than setting the temperatures on the RDT-5 screen). The stage activation temperature determines when cooling and heating operations take place. RDT-5 supports a 10-point temperature curve.

- Version 7.20 supports two RDT-5 units.
 - If your system includes two RDT-5 units, verify that the controller identifies both in Hardware Checklist, page 86.
 - Ensure that each unit has a unique address (refer to the RDT-5 Manual for details).
 - After installing the RDT-5 units, perform a Cold Start.

RDT-5 / Temp. Curve						
Day	Temp	Stage 1 COOL	Stage 2 HEAT	Stage 3 COOL	Stage 4 HEAT	Stage 5 HEAT
0	0.0	---	---	---	---	---
0	0.0	---	---	---	---	---
0	0.0	---	---	---	---	---
0	0.0	---	---	---	---	---
0	0.0	---	---	---	---	---
0	0.0	---	---	---	---	---
0	0.0	---	---	---	---	---
0	0.0	---	---	---	---	---
0	0.0	---	---	---	---	---
0	0.0	---	---	---	---	---
0	0.0	---	---	---	---	---
---	---	Stage 1	Stage 2	Stage 3	Stage 4	Stage 5
---	---	-2.0	-5.0	2.0	5.0	7.0

➡ Wire the Platinum Touch/Rotem One communication card to the RDT-5's communication card. Refer to the RDT-5 manual for details.

1. In Install > Communication, define the expansion device as Dig. Thermostat.
2. In Management > RDT-5 / Temp. Curve, define the parameters (up to a 10-point curve).
 - Day: The growth day
 - Temp.: The target temperature for that day.
 - Stage 1 – 5: The temperatures at which heating or cooling starts (read only)
 - RDT-5 Stage Difference: The differences from the target temperature at which heating or cooling starts at each stage (read only; set these numbers in the Help).

Platinum Touch/Rotem One automatically calculates and displays the stage activation temperatures.

CAUTION Verify that the RDT-5's growth day and the controller's growth day are the same! Days set differently means that the temperature curves will be asynchronous.

3. In RDT-5 / Temperature Curve> Set Definitions, define the parameters as required.

Notes:

- Platinum Touch/Rotem One does not store these temperatures; RDT-5 does. If you connect the Platinum Touch/Rotem One to a different RDT-5 unit, you must re-enter the temperature curve.
- If you previously defined the temperature curve in the RDT-5, Platinum Touch/Rotem One retrieves the data and you can edit the data in this screen.
- When connecting the RDT-5 to a Platinum Touch/Rotem One Controller:
 - If an Expansion box is currently connected to the controller, a message appears in the Message box when you disconnect the Extension box. However, no alarm is sent out.
 - After configuring the RDT-5, disconnect the unit from the Platinum Touch/Rotem One and reconnect the Extension box. If the Extension box is not reconnected, Platinum Touch/Rotem One sends out alarms.

4.12.2 RDT-5 / TEMPERATURE CURVE | SET DEFINITIONS

Parameter	Value
Stage 1 Diff	-2.0
Stage 2 Diff	-5.0
Stage 3 Diff	2.0
Stage 4 Diff	4.0
Stage 5 Diff	6.0
Stage 1 Type	HEAT
Stage 2 Type	HEAT

- Define the parameters as required:
 - **Stage 1 – 5 Diff:** Enter the difference from the target temperature that activates a heater or cooler for each stage. These numbers appear on the RDT-5 / Temperature Curve screen.
 - **Stage 1 – 5 Type:** Select Heat or Cool. Each RDT-5 relay serves as a heater or cooler relay. This parameter enables displaying the relay definition on the screen.

CAUTION *Selecting Heat or Cool in this screen does not define the relay; it only displays the relay type. Actual relay definition is done in the RDT-5 unit, by placing a jumper on certain pins. Meaning: if a relay is defined in this screen as a heater, but the jumper placement defines the relay as a cooler, the relay is a cooler. Refer to the RDT-5 manual for details.*

4.12.3 RDT-5 DIGITAL ALARM

If required, define up to two digital sensors to send an alarm noting that an RDT-5 is functioning. Refer to Digital Sensors, page 93.

Connect the RDT-5 Backup Active Port to the controller's digital input card. Refer to the installation manual.

CAUTION Verify that the input port defined in Installation > Digital Sensors matches the port on the digital input card used to connect the units!

4.12.4 SAVING AND LOADING RDT-5 TABLES

In Version 7.19, the Platinum One/Rotem One controller stores (backups) the RDT-5 temperature curve tables. This function enables transferring the tables from a configured RDT-5 to another, unconfigured RDT-5.

To transfer settings:

1. Wire an RDT-5 unit to the controller, perform a [Cold Start](#) (page), and define the temperature curve on the RDT-5 or on the controller (see the above sections).
2. Save the controllers settings to an SD card. Refer to Save Settings, page 128 for details.
3. Connect the second RDT-5 unit to the controller and perform a [Cold Start](#)
4. Upload settings from the SD card. Refer to Load Settings, page 128 for details. Verify that you are uploading the correct file!

NOTE If there is any interruption while uploading settings, the tables may not transfer. In this case, a message will appear informing you of the issue.

4.12.5 RDT-5, VERSION 7.22

In Platinum Pro Version 7.22.01, the growth day and days in the temperature curve can be set to -7 & up. RDT-5 Version 1.5.8 also supports this feature. However, if, when used together one of the products is operating using legacy software, there can be operational errors. The following table explains possible errors if the growth day and RDT-5 temperature curve days are defined as negative days when using legacy software for either product.

	Platinum V7.22	RDT-5 Ver 1.5.8
Platinum Pro V7.21		<ul style="list-style-type: none">• Negative days in the RDT-5 appear incorrectly.• RDT-5 functions may not operate properly.
RDT-5 Ver < 1.5.8	Negative days are not transmitted to the RDT-5. Both units operate as if they are operating using legacy software.	

CAUTION Munters recommends that users who employ RDT-5 units update that product's software when you update the Platinum Pro software to version 7.22.



4.13 Switches and Relays

This screen displays the current relay definitions and the relays' status.

Switches & Relays

Main

Auto
 On

01 Heat 1	02 Water Main 1	03 Water Bypass 1	04 Water Line 1	05 Stir Fan 1	06 Cool Pad 1	07 Fogger 1	08 Vent Open 1	09 Vent Close 1	10 Tunnel Open 1
11 Tunnel Close 1	12 Curtain Open 1	13 Curtain Close 1	14 Attic Open 1	15 Attic Close 1	16 Water 1	17 Feeder 1	18 Auger 1	19 Feed Line Up 1	20 Feed Line Down 1
21 Curtain Open 3	22 Curtain Close 3	23 Curtain Open 4	24 Curtain Close 4	25 Feeder 2	26 Auger 2	27 Feeder 4	28 Feeder 3	29 Water 3	30

5 History Menu

 Control	Temperature	Mortality	History View
 Management	Humidity	Heaters	Ammonia
 History	CO2	Radiant Heaters	Dosing
 System	Bird Weight	Variable Heaters	
 EXT System	Feed Conversion	Alarms	
	Water	Table Of Events	
	Feed	Power Consumption	

In the History Menu you can view data regarding:

- Temperature History
- Humidity History
- CO2 History
- Bird Weight History
- Feed Conversion
- Water Consumption History
- Feed Consumption History
- Mortality History
- Heaters History
- Radiant Heaters History
- Variable Heaters History
- Alarms History
- Events Log History
- Power Consumption
- History View
- Ammonia History
- Dosing History

5.1 Temperature History

The temperature history menu stores minimum, average and maximum temperatures by growth day. The average is weighted, so if most of the day has been warm the average is closer to the maximum than the minimum.

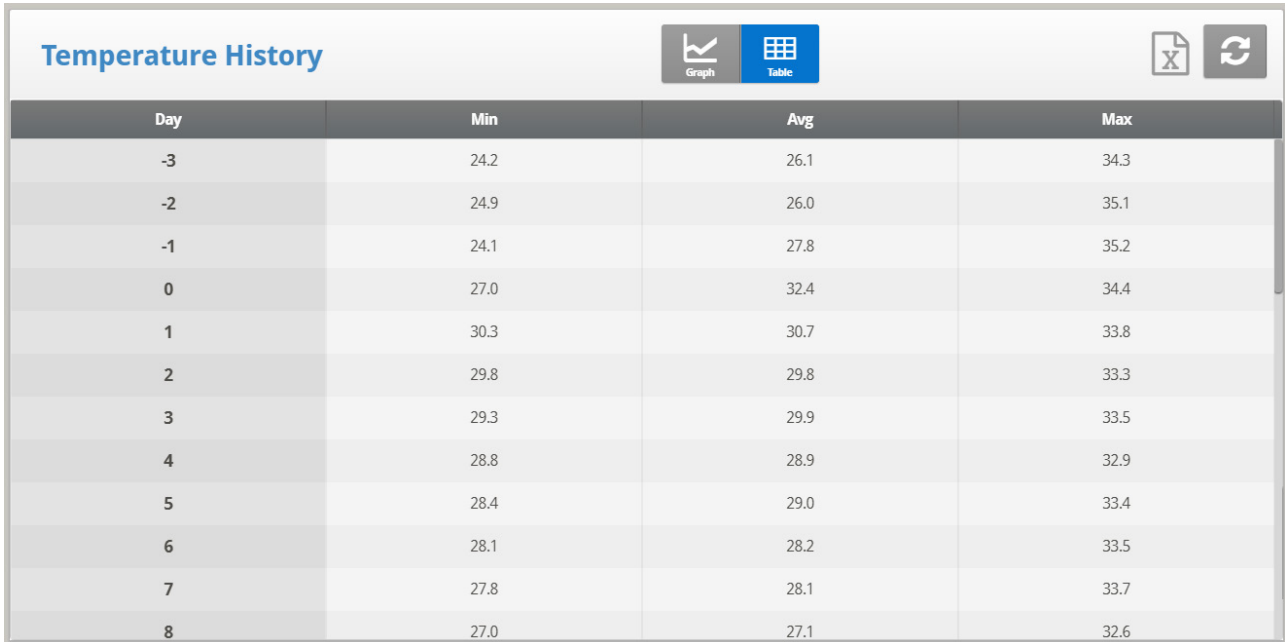

Day	Min	Avg	Max
-3	24.2	26.1	34.3
-2	24.9	26.0	35.1
-1	24.1	27.8	35.2
0	27.0	32.4	34.4
1	30.3	30.7	33.8
2	29.8	29.8	33.3
3	29.3	29.9	33.5
4	28.8	28.9	32.9
5	28.4	29.0	33.4
6	28.1	28.2	33.5
7	27.8	28.1	33.7
8	27.0	27.1	32.6

5.2 Humidity History

The humidity history menu stores minimum, average and maximum inside humidity by growth day. The average is weighted, so if most of the day has been humid the average is closer to the maximum than the minimum.

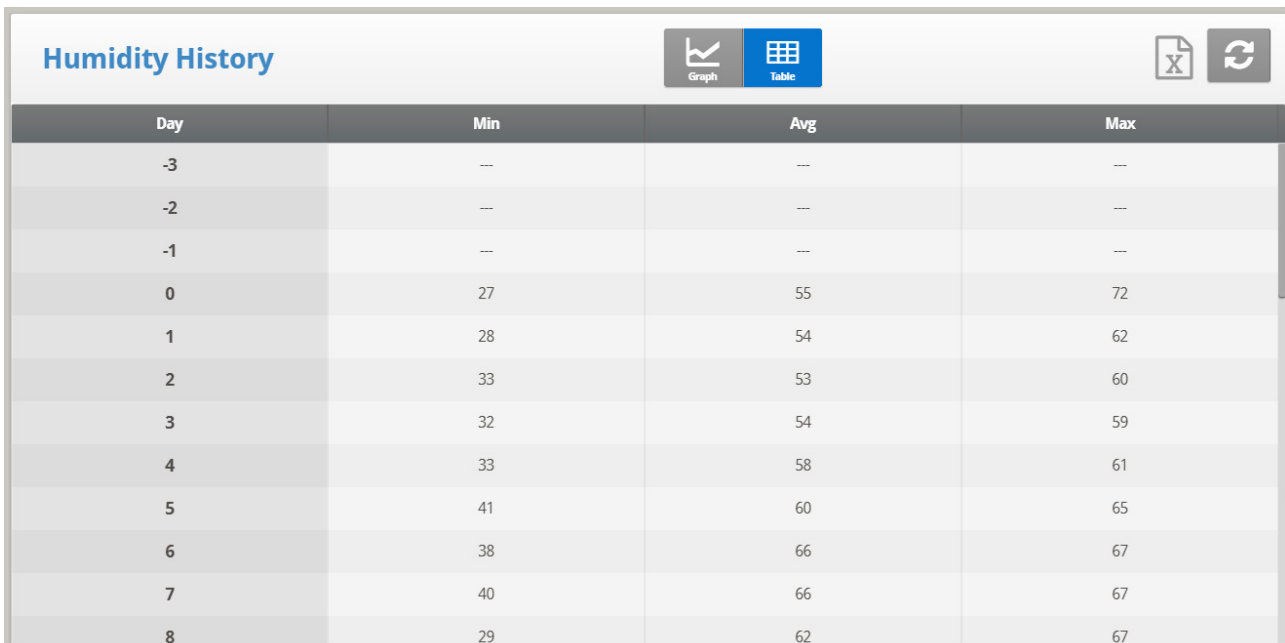

Day	Min	Avg	Max
-3	--	--	--
-2	--	--	--
-1	--	--	--
0	27	55	72
1	28	54	62
2	33	53	60
3	32	54	59
4	33	58	61
5	41	60	65
6	38	66	67
7	40	66	67
8	29	62	67

NOTE If two humidity sensors are installed, this screen displays their average. The History View display shows reading of both sensors only if they have been selected for logging.

5.3 CO2 History

The CO2 history menu stores minimum, average and maximum inside CO2 levels by growth day. The average is weighed, therefore if most of the day has high CO2 levels the average is closer to the maximum than the minimum.

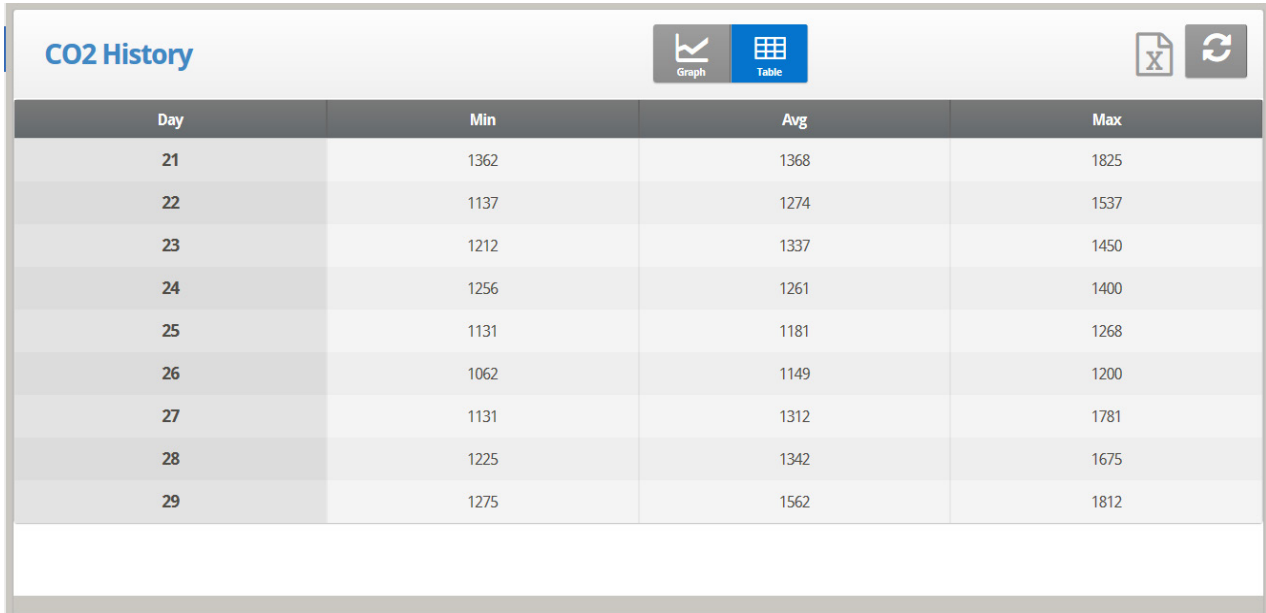

Day	Min	Avg	Max
21	1362	1368	1825
22	1137	1274	1537
23	1212	1337	1450
24	1256	1261	1400
25	1131	1181	1268
26	1062	1149	1200
27	1131	1312	1781
28	1225	1342	1675
29	1275	1562	1812

5.4 Bird Weight History

The scale history shows bird weight statistics. You can review daily data for each scale, or separately. The unit records up to two-bird scale data; if you have more than one scale-1 or one scale-2, their data is combined.

5.4.1 BIRD WEIGHT HISTORY, VERSION 7.18 AND BELOW

- In Version 7.17 and below, the unit records the data of up to two-bird scales; if you have more than one scale-1, data is combined.
- In Version 7.18, the controller records up to four scales.

Bird Weight History Graph Table X + ↻

Day	Common						Scale		
	Weight	Daily Gain	No. Of Weights	Std. Dev.	Uniformity	C.V.	Weight	Daily Gain	No. Of Weights
23	1.118	0.087	4,861	0.082	83	7	1.127	0.092	2,293
24	1.204	0.086	4,789	0.089	83	7	1.202	0.075	2,245
25	1.268	0.064	3,862	0.094	82	7	1.281	0.079	1,891
26	1.310	0.042	2,677	0.098	82	7	1.319	0.038	1,276
27	1.395	0.085	2,611	0.109	78	7	1.406	0.087	1,229
28	1.478	0.083	2,242	0.113	80	7	1.484	0.078	998
29	1.562	0.084	1,882	0.118	81	7	1.568	0.084	786
30	1.648	0.086	1,768	0.126	79	7	1.634	0.066	767
31	1.700	0.052	1,471	0.126	84	7	1.674	0.040	709
32	1.781	0.081	1,357	0.134	81	7	1.739	0.065	596
33	1.843	0.062	452	0.140	81	7	1.811	0.072	204

- If you select **SEXED** weighing, the history includes average data for the combined scales, and on the next screens separate data for each scale.
- If you select **MIXED** weighing, the history includes average data for all birds, and separate male and female data for Scale 1 and for Scale 2.
 - Use the arrow keys to scroll to the separated scale data, or up and down for data that is off screen.
 - The average and the number of weights are the usual definition. The Standard Deviation is the usual biased estimator (see a suitable textbook on statistical measurements). The Uniformity is the industry standard 10% uniformity (number of birds per 100 within 10% of the average weight), and the Coefficient of Variation or C.V. is the normalized standard deviation (standard deviation divided by average times 100 %).

5.4.2 HISTORY, VERSION 7.19

Bird Weight History Graph Table X + ↻

Day	Common				Scale 1				Scale 2	
	Average	Daily Gain	Uniformity	No.	Average	Daily Gain	Uniformity	No.	Average	Daily Gain
1	0.000	0.000	0	0	0.000	0.000	0	0	0.000	0.000
2	0.000	0.000	0	0	0.000	0.000	0	0	0.000	0.000
3	0.000	0.000	0	0	0.000	0.000	0	0	0.000	0.000
4	0.000	0.000	0	0	0.000	0.000	0	0	0.000	0.000
5	0.000	0.000	0	0	0.000	0.000	0	0	0.000	0.000
6	0.000	0.000	0	0	0.000	0.000	0	0	0.000	0.000
7	0.000	0.000	0	0	0.000	0.000	0	0	0.000	0.000

- The Daily Gain shows difference between the current average weight and the previous day's average weight; the data comes from all the scales.
- No daily gain is shown for individual scales.

5.5 Feed Conversion

This screen displays the amount of feed converted into the bird's weight.

Day	Bird Weight	Daily Feed	Feed Conversion
22	1.031	3,641.0	1
23	1.118	4,353.0	1
24	1.204	4,371.0	1
25	1.268	4,620.0	1
26	1.310	4,700.0	1
27	1.395	5,041.0	1
28	1.478	5,452.0	1
29	1.562	5,435.0	1
30	1.648	5,697.0	1
31	1.700	5,605.0	1
32	1.781	5,656.0	1
33	1.843	2,289.0	1



5.6 Water Consumption History

The water menu records daily water consumption and shows the daily differential change from the previous day in percent.

➡ **Connect the water monitor digital inputs.**

You can monitor up to two drinking water meters, total drinking water, total water, cool pad, fogger, and cool pad flush consumption. In Version 7.23, the user can monitor the water per bird.

Water Consumption History

Graph Table  

Day	Total Daily Water		Water Per Bird	Water-1		Water-2		Water-3	
	Total	Change (%)		Water-1	Change (%)	Water-2	Change (%)	Water-3	Change (%)
23	8,944	12	0.24	8,944	12	0	---	0	---
24	9,822	9	0.27	9,822	9	0	---	0	---
25	10,095	2	0.27	10,095	2	0	---	0	---
26	10,449	3	0.28	10,449	3	0	---	0	---
27	10,365	---	0.28	10,365	---	0	---	0	---
28	11,795	13	0.32	11,795	13	0	---	0	---
29	12,124	2	0.33	12,124	2	0	---	0	---
30	12,987	7	0.35	12,987	7	0	---	0	---
31	12,755	-2	0.35	12,755	-2	0	---	0	---
32	12,912	1	0.35	12,912	1	0	---	0	---
33	5,454	-2	0.15	5,454	-2	0	---	0	---



The screen displays the:

- Amount of water consumed
- Water/Feed Rate: Daily water consumption divided by daily feed intake
- Water per bird
- Daily percentage change

5.7 Feed Consumption History

The feed menu records daily feed consumption and shows the daily differential change from the previous day in percent for silos or fill systems.

Feed Consumption History

Graph Table  

Day	Daily Feed		Feed Per Bird	Feed-1 Daily		Feed-2 Daily		Feed-3 Daily		Feed-4 Daily	
	Total	Change (%)		Feed 1	Change (%)	Feed 2	Change (%)	Feed 3	Change (%)	Feed 4	Change (%)
23	4,353	19	0.12	10	-100	4,342	349	0	---	0	---
24	4,371	0	0.12	0	-100	4,371	0	0	---	0	---
25	4,620	-63	0.13	2,991	226	1,629	-63	0	---	0	---
26	4,700	1	0.13	4,700	57	0	-100	0	---	0	---
27	5,041	7	0.14	5,041	7	0	-100	0	---	0	---
28	5,452	8	0.15	5,452	8	0	0	0	---	0	---
29	5,435	---	0.15	5,435	---	0	0	0	---	0	---
30	5,697	4	0.15	5,686	4	11	0	0	---	0	---
31	5,605	-2	0.15	5,605	-2	0	-100	0	---	0	---
32	5,656	0	0.15	5,656	0	0	-100	0	---	0	---
33	2,289	0	0.06	2,289	0	0	0	0	---	0	---

- Install a feed silo weighing system to use the feed system or to monitor the auger system.

The feed data can be based on one of the following inputs. If more than one input is installed, priority is according to the order of the bulleted list.

- **Silo:** If silos (load cells) are installed, feed consumption data of each bin is based on the feed bin/silo weight.
- **Current Sense:** If Current Sense Relays for Augers are installed and calibrated (refer to [Current Sense Relay Calibration](#)), feed consumption data of each auger is based on the current sense, calculation method settings, and actual auger run-time. The run-time is calculated based on the measured current, when the actual current is higher than the nominal value.
- **Feed Count:** If a feed count sensor is installed feed consumption for each feed count input is based on the feed count method settings (refer to The mortality history menu maintains daily summaries of mortality, cull, and total dead. It also shows the percentage dead and gives an updated count of bird inventory. The history is maintained separately for male, female and total. Use the left and right arrow keys to switch to the next screen.

5.8 Mortality History

Mortality History									
Day	Total Mortality (%)			Total Mortality (No.)			Dead Birds		
	Female	Male	Total	Female	Male	Total	Female	Male	Total
23	0	3	3	0	0	0	0	0	0
24	0	3	3	0	12	12	0	12	12
25	0	3	3	0	5	5	0	5	5
26	0	3	3	0	8	8	0	8	8
27	0	3	3	0	22	22	0	22	22
28	0	3	3	0	14	14	0	14	14
29	0	3	3	0	23	23	0	23	23
30	0	3	3	0	20	20	0	20	20
31	0	3	3	0	13	13	0	13	13
32	0	3	3	0	18	18	0	18	18
33	0	3	3	0	5	5	0	5	5

The mortality history menu maintains daily summaries of mortality percentages, culled, and total dead. It also shows the percentage dead and gives an updated count of bird inventory. The history is maintained separately for male, female and total. Use the left and right arrow keys to switch to the next screen.

5.9 Heaters History

Platinum Touch / Rotem One maintains daily total run times of each heater. The data is in hours:minutes format.

Heaters History													
Hours													
Day	Heater 1	Heater 2	Heater 3	Heater 4	Heater 5	Heater 6	Heater 7	Heater 8	Heater 9	Heater 10	Heater 11	Heater 12	Heater 13
0	02:18	01:19	01:31	02:01	00:00	00:00	00:00	00:00	00:00	00:00	00:00	00:00	00:00
1	03:30	02:07	02:32	03:00	00:00	00:00	00:00	00:00	00:00	00:00	00:00	00:00	00:00
2	03:10	02:18	02:40	02:16	00:00	00:00	00:00	00:00	00:00	00:00	00:00	00:00	00:00
3	02:46	02:07	02:07	01:51	00:00	00:00	00:00	00:00	00:00	00:00	00:00	00:00	00:00
4	02:27	01:38	01:56	01:35	00:00	00:00	00:00	00:00	00:00	00:00	00:00	00:00	00:00
5	02:15	01:25	01:35	01:44	00:00	00:00	00:00	00:00	00:00	00:00	00:00	00:00	00:00
6	01:35	00:47	01:00	00:55	00:00	00:00	00:00	00:00	00:00	00:00	00:00	00:00	00:00
7	02:02	01:04	01:49	01:12	00:00	00:00	00:00	00:00	00:00	00:00	00:00	00:00	00:00
8	02:34	01:53	02:03	01:44	00:00	00:00	00:00	00:00	00:00	00:00	00:00	00:00	00:00
9	02:59	01:54	02:15	02:14	00:00	00:00	00:00	00:00	00:00	00:00	00:00	00:00	00:00
10	02:56	02:01	02:04	02:11	00:00	00:00	00:00	00:00	00:00	00:00	00:00	00:00	00:00

5.10 Radiant Heaters History

Platinum Touch / Rotem One maintains daily total run times of each radiant heater, including separate data for low level and high-level heaters. The table fills several screens; to view the off-screen data, use the arrow keys to scroll. The data is in hours:minutes format.

Radiant Heaters History																									
Day	Heater 1		Heater 2		Heater 3		Heater 4		Heater 5		Heater 6		Heater 7		Heater 8		Heater 9		Heater 10		Heater 11		Heater 12		
	Low	High	Low	High	Low	High	Low	High	Low	High	Low	High	Low	High	Low	High	Low	High	Low	High	Low	High	Low		
23	00:00	00:00	00:00	00:00	00:00	00:00	00:00	00:00	00:00	00:00	00:00	00:00	00:00	00:00	00:00	00:00	00:00	00:00	00:00	00:00	00:00	00:00	00:00	00:00	
24	00:00	00:00	00:00	00:00	00:00	00:00	00:00	00:00	00:00	00:00	00:00	00:00	00:00	00:00	00:00	00:00	00:00	00:00	00:00	00:00	00:00	00:00	00:00	00:00	00:00
25	00:00	00:00	00:00	00:00	00:00	00:00	00:00	00:00	00:00	00:00	00:00	00:00	00:00	00:00	00:00	00:00	00:00	00:00	00:00	00:00	00:00	00:00	00:00	00:00	00:00
26	00:00	00:00	00:00	00:00	00:00	00:00	00:00	00:00	00:00	00:00	00:00	00:00	00:00	00:00	00:00	00:00	00:00	00:00	00:00	00:00	00:00	00:00	00:00	00:00	00:00

5.11 Variable Heaters History

The controller tracks the operating time of the variable heaters. The table fills several screens; to view the off-screen data, use the arrow keys to scroll. The data is in hours:minutes format.

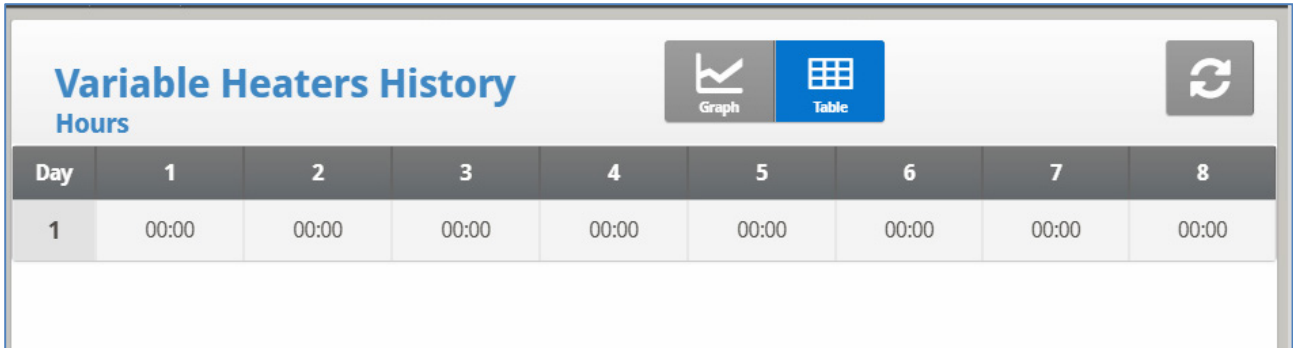

Day	1	2	3	4	5	6	7	8
1	00:00	00:00	00:00	00:00	00:00	00:00	00:00	00:00

5.12 Alarms History

The alarm history records the growth day and time of each alarm. Alarms that are currently active show up as flashing on the screen. Alarm history is not reset when using Management, Growth Date & Flock > Start New Flock. The last 250 alarms are saved, and as the table is filled, new alarms push out the older alarms.



Day	Time	Message
28	10:00:00	Alarm Test
29	07:25:46	Below Minimum Air
29	10:00:00	Alarm Test
30	10:00:00	Alarm Test
31	10:00:00	Alarm Test
31	22:49:52	Below Minimum Air
32	06:07:04	Switches Changed
32	10:00:00	Alarm Test
32	13:59:12	Low Water Pressure
32	18:35:56	Low Water Pressure
33	00:01:16	Below Minimum Air
33	10:00:00	Alarm Test

5.13 Events Log History

The Platinum Touch / Rotem One records significant events with growth day and time stamp. The Table of Events is 1000 events long and is not reset when using Management, Growth Date & Flock > Start New Flock. New events push out the older events.

Table of Events  

Day	Time	Message
1	14:46:48	Cold Start
1	14:46:48	Min Ventilation
1	14:47:36	Data Read From Plug
1	14:47:36	Power Off
1	14:47:48	Power On
2	14:49:30	Changed Growth Day
2	15:11:52	Reset Alarm
3	10:00:00	Alarm Test
4	07:07:40	Change Silo 1 Inventory
4	07:07:40	Change Silo 2 Inventory
4	10:00:00	Alarm Test



1 - 100 of 514 items

Typical events recorded are switch changes, entry into tunnel mode, natural or minimum ventilation, alarm resets, ventilation mode changes and more. The Table of Events is an excellent tool to determine whether your controller is going in and out of tunnel due to marginal settings as well as finding and identifying problems.

5.14 Power Consumption

This menu displays the daily power consumption (in kWh) of the heaters, fans, lights and other equipment and the change from the previous day.

NOTE Current sense relays are required for this function to be enabled (single phase electricity only).

Power Consumption
Current Sense  

Day	Heaters	Fans	Lights	Others	Total	Change (%)
22	0	0	0	0	0	--
23	0	0	0	0	0	--
24	0	0	0	0	0	--
25	0	0	0	0	0	--
26	0	0	0	0	0	--

5.15 History View

The History View menu has detailed history on a variety of sensors and data. Go to Help > Set under History View to select the particular data to collect.

History View							
Day	Time	Target Temp.	House Temp Min	House Temp Avg	House Temp Max	Temp 1 Avg	Temp 2 Avg
30	21:00	24.6	25.2	25.2	25.5	24.7	25.1
30	21:15	24.6	25.0	25.0	25.3	24.4	25.0
30	21:30	24.6	25.0	25.5	25.6	25.0	25.3
30	21:45	24.6	25.1	25.1	25.5	24.5	25.0
30	22:00	24.6	24.8	24.8	25.1	24.2	24.8
30	22:15	24.6	24.7	24.7	24.8	24.2	24.6
30	22:30	24.6	24.5	25.0	25.0	24.4	24.9
30	22:45	24.6	24.6	24.6	25.1	23.8	24.5
30	23:00	24.6	24.5	24.6	24.6	23.8	24.5
30	23:15	24.6	24.5	24.6	24.8	23.9	24.6
30	23:30	24.6	24.5	24.5	24.7	23.9	24.4

1. In *System > Setup > History Resolution*, set the frequency of your data collection. Factory default collects one-hour data on a selection from the choices below.
2. Under **Help | Graph** you can select a variety of graphs of the detailed history.
3. If required, click  and set the parameters.

History View - Settings					
Growth Day	<input checked="" type="checkbox"/>	Time	<input checked="" type="checkbox"/>	Target Temp.	<input checked="" type="checkbox"/>
House Temp Min	<input checked="" type="checkbox"/>	House Temp Avg	<input checked="" type="checkbox"/>	House Temp Max	<input checked="" type="checkbox"/>
Temp 1 Min	<input type="checkbox"/>	Temp 1 Avg	<input checked="" type="checkbox"/>	Temp 1 Max	<input type="checkbox"/>
Temp 2 Min	<input type="checkbox"/>	Temp 2 Avg	<input checked="" type="checkbox"/>	Temp 2 Max	<input type="checkbox"/>
Temp 3 Min	<input type="checkbox"/>	Temp 3 Avg	<input checked="" type="checkbox"/>	Temp 3 Max	<input type="checkbox"/>
Temp 4 Min	<input type="checkbox"/>	Temp 4 Avg	<input checked="" type="checkbox"/>	Temp 4 Max	<input type="checkbox"/>
Temp 5 Min	<input type="checkbox"/>	Temp 5 Avg	<input checked="" type="checkbox"/>	Temp 5 Max	<input type="checkbox"/>

The options are:

- Target Temp.
- House Temperature Minimum, Average and Maximum

- Temp – 1-6 Average
- Attic Sensor Minimum, Average and Maximum
- Outside Temperature Minimum, Average and Maximum
- Humidity In/Out Minimum, Average and Maximum
- Water Consumption
- Feed Consumption
- Level of Ventilation

NOTE Altering choices erases old data and starts a fresh data set.

5.16 Ammonia History

This screen displays the minimum, average, and maximum ammonia levels, by growth day.

Day	Min	Avg	Max
-2	--	--	--
-2	--	--	--
-1	--	--	--
0	--	--	--

5.17 Dosing History

This screen displays the date, total work time, water volume transmitted, and total volume of dosage material added. Because the type of additive can be changed, the controller records each additive's history separately.

Day	Additive	Work Time 1	Water 1	Dose 1	Additive	Work Time 2	Water 2	Dose 2	Additive	Work Time
1	None	00:00:00	0.0	0.000	None	00:00:00	0.0	668749...	None	00:00:00



- Version 7.22: Scroll right and left to view the history of each particular pump.

6 System Menu



 Control	Scale Testing	Analog Output	Scale Settings
 Management	Hardware Checklist	Temperature Definition	Silo/Auger Layout
 History	Setup	Temperature & Timer	Communication
 System	Time & Date	Vent/Curt Setup	Scale Layout
	Variable Speed Fans Setting	House Dimensions	Version
	Relay Layout	Fan Air Capacity	
	Sensors	Bird Curve	

- Scales Testing
- Hardware Checklist
- Setup
- Time & Date
- Variable Speed Fan Setting
- Relay Layout
- Sensors
- Analog Output
- Temperature Definition
- Temp & Timer Setting
- Vent Curtain Setup
- House Dimensions
- Fan Air Capacity
- Setting up a Bird Weight Curve - Summary
- Non-Gender Based Weighing
- Gender Based Weighing
- Silo / Auger Layout
- Communication
- Scale Layout

6.1 Scales Testing

Scale Testing  			
Type	Weight	A/D	Status
Scale 1	0.000	0	N/A
Scale 2	0.000	0	N/A
Silo 1	630	0	N/A
Silo 2	681	0	N/A
FeedScale 1	0.000	0	N/A
Scale 3	0.000	0	N/A

6.2 Hardware Checklist

Hardware Checklist  				
Card	Box	Slot	Channel	
<ul style="list-style-type: none"> Analog Input <ul style="list-style-type: none"> Analog Input 1 Main 2 12 Digital Input <ul style="list-style-type: none"> Digital Input 1 Main 1 12 Analog Output <ul style="list-style-type: none"> Analog Output 1 Main 3 10 Scales <ul style="list-style-type: none"> Scales 3 Main 4 6 Static Pressure <ul style="list-style-type: none"> Static Pressure 1 Main N/A 1 Alarm <ul style="list-style-type: none"> Alarm 1 Main N/A 1 				

Check the installed hardware that has been identified by the Plug and Play system. The system detects all cards except communication. The standard optional communication card provides lightning protection and does not have local computerized intelligence to identify itself to the system. Note that if a card is missing, turn the power OFF and then ON for a card rescan.

6.3 Setup

- Setup Main Screen
- Static Pressure Unit Definition

6.3.1 SETUP MAIN SCREEN

The screenshot shows a 'Setup' screen with a title bar and two icons (envelope and refresh). The main content is a table of settings:

Vent. Mode	STANDARD	Temperature Unit	<input checked="" type="radio"/> F° <input type="radio"/>
Pressure Unit	IN.W.C ▾	Wind Speed Units	Feet/Min ▾
Fan Air Capacity Unit	<input checked="" type="radio"/> CFM <input type="radio"/>	Length Unit	<input checked="" type="radio"/> Non Metric <input type="radio"/>
Weight Unit	<input checked="" type="radio"/> LB <input type="radio"/>	Growing Zones 1-4	1 ✎
Minimum Ventilation (Power)	<input checked="" type="radio"/> Yes <input type="radio"/>	Natural Ventilation	No ▾
Tunnel	<input checked="" type="radio"/> Yes <input type="radio"/>	History Resolution	1 Hour ▾

- Define:
 - **Temperature Unit:** Celsius / Fahrenheit
 - **Static Pressure Unit:** Milibar / Inches of WC (Water Column) / Pascal / cm of WC / mm of WC / None
 - **Wind Speed Unit:** Km Per Hour / Mile per Hour / Meter per Sec / Feet per Sec/Feet per Minute
 - **Fan Air Capacity Unit:** Cubic feet per minute (CFM) / Cubic meter per hour (M3/H)
 - **Length Unit:** Metric/ Non-Metric
 - **Weight Unit:** Pounds (LB) / Kilograms (KG)
 - **Growing Zones 1 - 4:** 1/2/3/4
 - **Minimum Ventilation (Power):** YES / NO
 - **Natural Ventilation:** No / Yes
 - **Tunnel:** YES / NO
 - **History Resolution:** 1 minute / 5 minute / 10 minute / 15 minute / 30 minute / 1 hour / 2 hours

6.3.2 STATIC PRESSURE UNIT DEFINITION

Enabling/disabling a static pressure unit determines the ventilation method used in the chicken/animal house:

- **Static pressure unit enabled:** After selecting any method, refer to [Static Pressure](#), page 23 to define the static pressure parameters.
- **No unit enabled:** If you choose **None**, ventilation is controlled by time or a potentiometer.

6.4 Time & Date

This menu sets the current time and date for the controller.

Field	Value
Current Time	23:28
Date	22-Sep-19
Day Of The Week	Sunday

- **Define:**
 - **Current Time:** Enter the current time in 24-hour format.
 - **Date:** Enter the date in day-month-year format.
 - **Day of the Week:** Select the day of the week from the drop-down menu.

6.5 Variable Speed Fan Setting

- Variable Speed Main Screen
- - Speed Fan Help | Set Definitions

6.5.1 VARIABLE SPEED MAIN SCREEN

This section details the configuration procedure.

➤ This function requires an Analog Output card in the controller.

1. In *System > Analog Output*, configure:
 - a. analog outputs as variable speed fans.
 - b. the minimum and maximum voltage output for each fan.

Output No.	Function	Output Function	Min V.Out	Max V.Out
Card 1 Main Slot 3				
1	Tunnel Fan	1	0.0	10.0
2	Tunnel Fan	2	0.0	10.0
3	Tunnel Fan	3	0.0	10.0
4	Tunnel Fan	4	0.0	10.0
5	Tunnel Curtain	2	0.0	10.0
6	Curtain	2	0.0	10.0
7	Light Dimmer	1	0.0	10.0
8	Light Dimmer	2	0.0	10.0

2. In *System > Variable Speed Fans Setting*, set the following parameters (refer to Figure 7):

Variable Speed Fans Setting		
Variable Fan	Minimum	Maximum
Tunnel Fan 1	30	100
Tunnel Fan 2	30	100
Tunnel Fan 3	30	100
Tunnel Fan 4	30	100

- Min: The minimum fan speed/analog output (in percentage)
- Max: The maximum fan speed/analog output (in percentage)

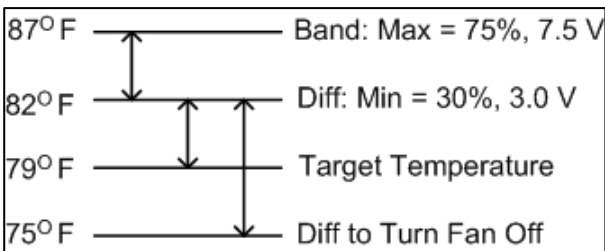

Figure 7: Variable Speed Fan Example

3. Set the Help parameters as required.
4. In *System > Temperature & Timer*, scroll to MT.
4. Enable M and/or T as required.
5. Under Option, select the on/off schedule:
 - Min.V: When in minimum ventilation, fans run on the schedule defined in *Control > Minimum Vent Timer*.
 - ----: When in minimum ventilation, fans run continually.

6.5.2 VARIABLE SPEED FAN HELP | SET DEFINITIONS

V. Speed Settings	
Diff. To Turn Fan Off	-20.0
Day To Turn Fan Off	0



- **Diff to Turn Fan Off.** If required, the variable fan can operate at minimum ventilation below the Target Temperature. This parameter configures the temperature below the Target Temperature at which ventilation runs at minimum. In Figure 7, the F. MV Off is 7° F. Default is 0° F
- **Day to Disable Fan Off:** The growth day at which the variable speed fan ceases to operate.

6.6 Relay Layout

- Relay Outlet Main Screen
- Output Function List

6.6.1 RELAY OUTLET MAIN SCREEN

Use this screen to define the devices connected to the controller.

Relay Layout					
Relay No.	Device	No.	N.C.		
↳ Card 1 Main Slot 1					
1	Heat	1	<input type="checkbox"/>		
2	Water Main	1	<input type="checkbox"/>		
3	Water Bypass	1	<input type="checkbox"/>		
4	Water Line	1	<input type="checkbox"/>		
5	Stir Fan	1	<input type="checkbox"/>		
6	Cool Pad	1	<input type="checkbox"/>		
7	Fogger	1	<input type="checkbox"/>		
8	Vent Open	1	<input type="checkbox"/>		
9	Vent Close	1	<input type="checkbox"/>		
10	Tunnel Open	1	<input type="checkbox"/>		

1. Go to *System* > *Relay Layout*.
2. Select the required relay from the drop-down list (refer to [Output Function List](#)).

NOTE If required, you can set the relay number manually.

- Enter relays according to equipment installation (technician I/O list) using up/down arrow keys.
3. If required, click  and set the parameters.
 - If you have installed Current Sense relays, Platinum Touch / Rotem One defines them automatically. Current sense relays transmit to the user's PC the amount of the current being passed to the relay and send alarms when the current is too low or too high. In addition, you can view the daily electricity consumption in History. Refer to [Current Sense Relay Calibration](#) for calibration instructions.

6.6.2 OUTPUT FUNCTION LIST

	Relay Name	Quantity Supported
1.	Heaters	16
2.	Radiant Heaters Low	16
3.	Radiant Heaters High	16
4.	Radiant Heaters Ignite	16

	Relay Name	Quantity Supported
5.	Tunnel Fan	30
6.	Exhaust Fan	20
7.	Stir Fan	15
8.	Cooling	4
9.	Cooling Pad	4
10.	Fogger	4
11.	Vent Open	4
12.	Vent Close	4
13.	Tunnel Open	4
14.	Tunnel Close	4
15.	Curtain Open	4
16.	Curtain Close	4
17.	Attic Open	1
18.	Attic Close	1
19.	Vent Speed	1
20.	Light	4
21.	Water	4
22.	Feeder	4
23.	Auger	4
24.	Extra System	4
25.	Alarm (N.C.)	1
26.	Fail Safe (N.C.)	1
27.	Feeder Win Open	1
28.	Feeder Win Close	1
29.	Feeder Line Up	1
30.	Feeder Line Down	1
31.	Drink Line Up	1
32.	Drink Line Down	1
33.	Water Main	1
34.	Water Bypass	1
35.	Water Line	10
36.	WOD	4
37.	AS Relay	8
38.	AS Analog Output	8

6.7 Sensors

- [Analog Sensors](#)
- [Digital Sensors](#)

6.7.1 ANALOG SENSORS

➡ Install analog input cards.

This screen enables the user to define the analog sensors. The Platinum Touch / Rotem One regards temperature, humidity, and CO2 sensors and circuit breaker as analog sensors. These sensors measure a continuous range rather than just on or off.

Output No.	Function	Sensor No.
↳ Card 1 Main Slot 2		
1	Temperature	1
2	Temperature	2
3	Temperature	3
4	Temperature	4
5	Temperature	5
6	Temperature	6
7	Humidity Sensor In	1
8	Humidity Sensor Out	1
9	CO2 Sensor	1

1. Go to *System > Sensors > Analog*.

2. On each input, define the sensor as required using the drop-down list.

NOTE If sensor numbers duplicate, the sensors average.

6.7.2 DIGITAL SENSORS

➤ Install digital input cards.

This screen enables configuring the installed digital sensors. These sensors monitor both water and feed consumption if the building is equipped accordingly. Digital inputs include on/off and pulsing inputs such as auxiliary alarms, pulsing water meters and feed.

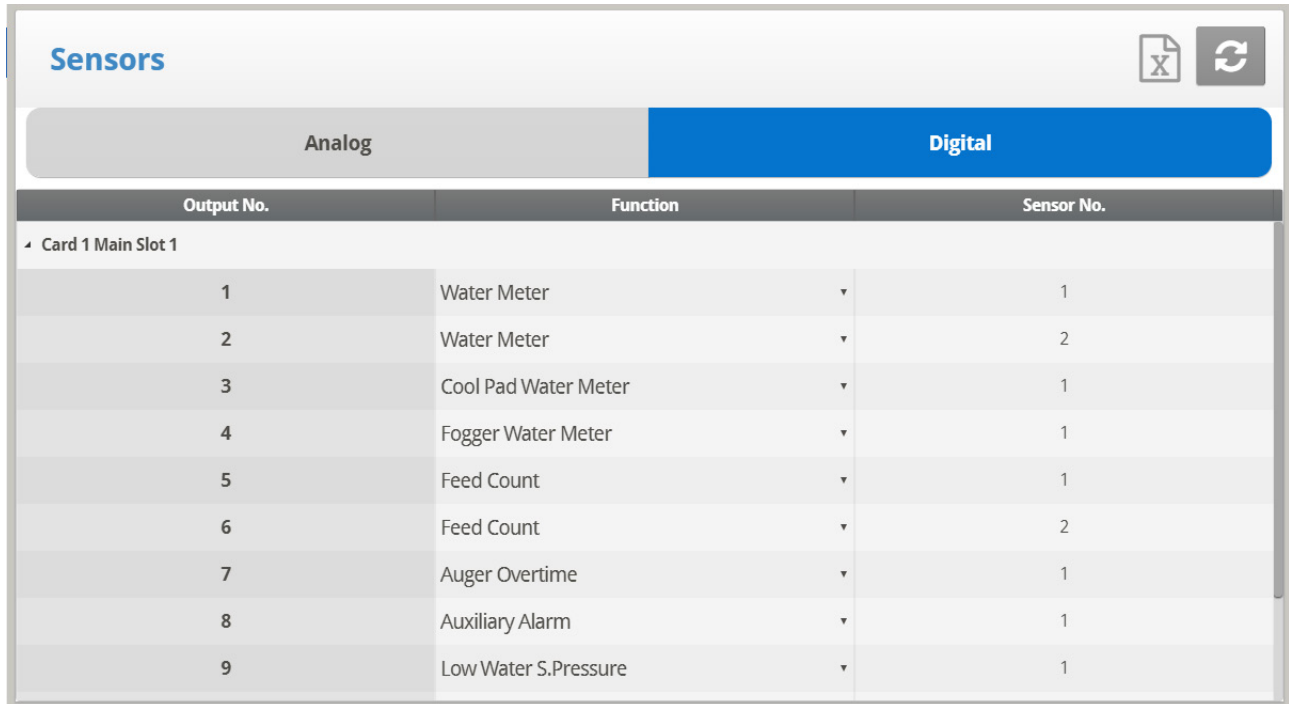

The screenshot shows a web interface titled "Sensors" with a navigation bar containing "Analog" and "Digital" tabs. The "Digital" tab is selected. Below the tabs is a table with three columns: "Output No.", "Function", and "Sensor No.". The table is expanded to show "Card 1 Main Slot 1" with 9 rows of sensor configurations. Each row includes an "Output No.", a "Function" with a dropdown arrow, and a "Sensor No.".

Output No.	Function	Sensor No.
Card 1 Main Slot 1		
1	Water Meter	1
2	Water Meter	2
3	Cool Pad Water Meter	1
4	Fogger Water Meter	1
5	Feed Count	1
6	Feed Count	2
7	Auger Overtime	1
8	Auxiliary Alarm	1
9	Low Water S.Pressure	1

1. Go to *System > Sensors > Digital*.
2. On each input, define the sensor as required using the drop-down list.
 - Platinum Touch / Rotem One automatically numbers the sensors according to their function.
 - You cannot define more than the permitted number of any particular sensor. For example, you can define one function as Cool Pad Water Meter, not two.

6.8 Analog Output

- Analog Output Main Screen
- Analog Output Settings

6.8.1 ANALOG OUTPUT MAIN SCREEN

Analog output can be used to control:

- Variable speed fans
- Light dimmers
- Variable stir fans
- Tunnels
- Vents
- Curtains

➡ Install analog output cards.

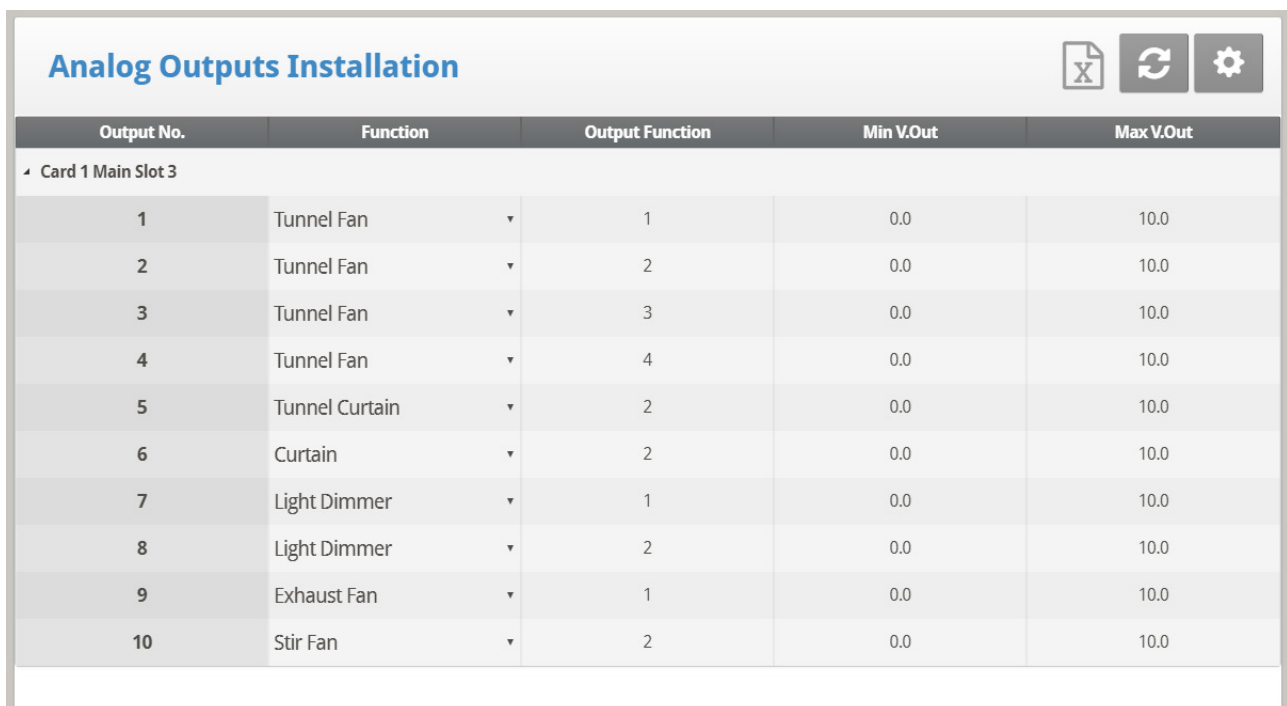

Output No.	Function	Output Function	Min V.Out	Max V.Out
Card 1 Main Slot 3				
1	Tunnel Fan	1	0.0	10.0
2	Tunnel Fan	2	0.0	10.0
3	Tunnel Fan	3	0.0	10.0
4	Tunnel Fan	4	0.0	10.0
5	Tunnel Curtain	2	0.0	10.0
6	Curtain	2	0.0	10.0
7	Light Dimmer	1	0.0	10.0
8	Light Dimmer	2	0.0	10.0
9	Exhaust Fan	1	0.0	10.0
10	Stir Fan	2	0.0	10.0

1. Go to *System > Analog Output*.
2. Enter the devices wired to each input (setup according to technician).

6.8.2 ANALOG OUTPUT SETTINGS

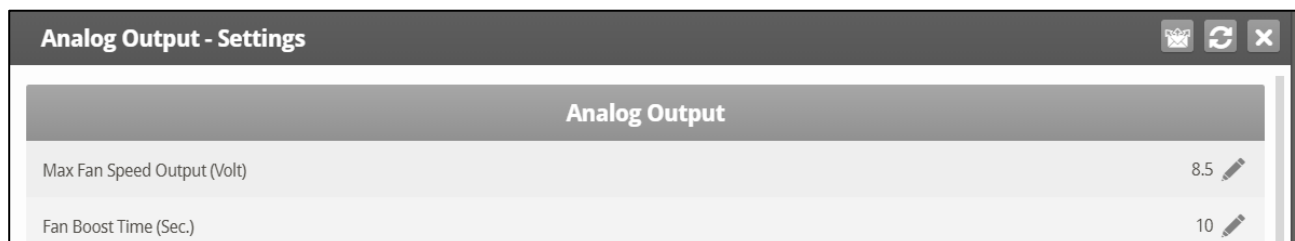

Analog Output	
Max Fan Speed Output (Volt)	8.5
Fan Boost Time (Sec.)	10

- Define:
 - Max Fan Speed Output (Volt): This parameter works as an override to the Maximum Voltage Output.
 - Fan Boost Time:

6.9 Temperature Definition

This screen assigns specific temperature sensors for various brood setups and for heater zones. Moreover, assigning sensors to particular devices is possible. Note that if the sensors selection remains blank, the default value is assigned.

Choose 1 to 18 temperature sensors for each item listed. The house, brooding and tunnel sensors cause the current average to apply to devices when no specific sensor is assigned to them. The current average substitutes for either failed or missing sensors.

NOTE Sensors 10 – 18 require installing a second analog card.

Temperature Definition						
Function	Sensors					
	1	2	3	4	5	6
Full House	<input type="checkbox"/>	<input checked="" type="checkbox"/>	<input checked="" type="checkbox"/>	<input checked="" type="checkbox"/>	<input checked="" type="checkbox"/>	<input checked="" type="checkbox"/>
Tunnel	<input type="checkbox"/>	<input type="checkbox"/>	<input type="checkbox"/>	<input type="checkbox"/>	<input type="checkbox"/>	<input type="checkbox"/>
Attic	<input type="checkbox"/>	<input type="checkbox"/>	<input type="checkbox"/>	<input type="checkbox"/>	<input type="checkbox"/>	<input type="checkbox"/>
Outside	<input type="checkbox"/>	<input type="checkbox"/>	<input type="checkbox"/>	<input type="checkbox"/>	<input type="checkbox"/>	<input type="checkbox"/>
Heat 1	<input type="checkbox"/>	<input type="checkbox"/>	<input type="checkbox"/>	<input type="checkbox"/>	<input type="checkbox"/>	<input type="checkbox"/>
Stir Fan 1	<input type="checkbox"/>	<input type="checkbox"/>	<input type="checkbox"/>	<input type="checkbox"/>	<input type="checkbox"/>	<input type="checkbox"/>
~ Stir Fan 2	<input type="checkbox"/>	<input type="checkbox"/>	<input type="checkbox"/>	<input type="checkbox"/>	<input type="checkbox"/>	<input type="checkbox"/>
Cool Pad 1	<input type="checkbox"/>	<input type="checkbox"/>	<input type="checkbox"/>	<input type="checkbox"/>	<input type="checkbox"/>	<input type="checkbox"/>
Fogger 1	<input type="checkbox"/>	<input type="checkbox"/>	<input type="checkbox"/>	<input type="checkbox"/>	<input type="checkbox"/>	<input type="checkbox"/>
Curtain 1	<input type="checkbox"/>	<input type="checkbox"/>	<input type="checkbox"/>	<input type="checkbox"/>	<input type="checkbox"/>	<input type="checkbox"/>
~ Curtain 2	<input type="checkbox"/>	<input type="checkbox"/>	<input type="checkbox"/>	<input type="checkbox"/>	<input type="checkbox"/>	<input type="checkbox"/>

- Refer to [Temperature Curve](#).
- Assign Temperature Sensors as required in System > Temp Definition. Devices that do not accept temperature sensors, such as Exhaust Fans, Tunnel Fans, Feed and Light do not appear.

NOTE If you are using two (2) input analog cards, the screen displays Temp. Sensor(s) 1-18 (refer to above screen capture).

NOTE When an attic sensor is not installed, the attic vent is disabled.

NOTE The ~ symbol designates an analog output device.

This section enables the user to set the temperature and the timer setting for all heating and cooling devices.

6.10 Temp & Timer Setting

- Temp & Timer Main Screen
- Temp & Timer Settings Help | Set

6.10.1 TEMP & TIMER MAIN SCREEN

Temperature & Timer Settings						
Device	On	Off	MNT			Option
			Min Vent	Natural	Tunnel	
Cool Pad 1	31.7	31.1	<input type="checkbox"/>	<input type="checkbox"/>	<input checked="" type="checkbox"/>	None
* Tunnel Fan 4	31.1	29.4	<input type="checkbox"/>	<input type="checkbox"/>	<input checked="" type="checkbox"/>	None
* Tunnel Fan 3	31.1	29.4	<input type="checkbox"/>	<input type="checkbox"/>	<input checked="" type="checkbox"/>	None
* Tunnel Fan 2	31.1	29.4	<input type="checkbox"/>	<input type="checkbox"/>	<input checked="" type="checkbox"/>	None
* Tunnel Fan 1	31.1	29.4	<input type="checkbox"/>	<input type="checkbox"/>	<input checked="" type="checkbox"/>	None
Tunnel Setting	31.1	29.4	<input type="checkbox"/>	<input type="checkbox"/>	<input type="checkbox"/>	
* Curtain Open 2	29.4	28.3	<input type="checkbox"/>	<input checked="" type="checkbox"/>	<input type="checkbox"/>	
* Curtain Open 1	29.4	28.3	<input type="checkbox"/>	<input checked="" type="checkbox"/>	<input type="checkbox"/>	
Fogger 1	28.3	27.8	<input checked="" type="checkbox"/>	<input type="checkbox"/>	<input type="checkbox"/>	None
* Stir Fan 2	27.2	26.7	<input type="checkbox"/>	<input type="checkbox"/>	<input type="checkbox"/>	None
Stir Fan 1	27.2	26.7	<input type="checkbox"/>	<input type="checkbox"/>	<input type="checkbox"/>	None

This section enables the user to set the temperature and the timer setting for all heating and cooling devices.

1. Define devices as required in the Installation Menu (Relay Layout, Analog Sensors, and Analog Output).
2. Define the fields as required.
 - **Device:** Read only. This column lists the devices defined in the Installation Menu.
 - **On/Off:** Set the temperature at which the device starts/stops operating.
 - **MT:** These letters stand for Minimum Ventilation/Tunnel. Press the +/- key to enable each cooling device to work in the mode(s) required. You can choose both modes if required.

NOTE: *Minimum Vent (Power) and Tunnel Ventilation must be enabled in System > Setup for this function to operate.*

- **Option:** Set the timing method for each device. The choices available depend on the device.
 - Ventilation device:
 - **Min.V:** The device only works according to the On/OFF schedule set in *Control > Minimum Vent Timer*. It does not switch to tunnel mode.
 - **----**: This ventilation device works according to the on/off temperature only (no cycling). When the temperature is above the ON temperature, the fan remains on. When the temperature is below the OFF temperature, the fan remains off. In between those two temperatures

- Foggers and cooling pads:
 - **Timer 1/2/3/4:** The cooling device operates between the temperatures set in the Temperature and Timer Settings screen, according to the on/off schedule defined in *Control > Timer Setting*. Select which timer defines the schedule.
 - **Program:** This selection disables the parameters set in this page. The cooling device works according to the device's program screen. Foggers operate according to the parameters set in *Control > Foggers*. Cooling pads operate according to the parameters set in *Control > Cooling Pad*.
 - **----:** This cooling device works according to the on/off temperature only (no cycling).
 - When the temperature is above the ON temperature, the fans operate.
 - When the temperature is below the OFF temperature, the fans cease to operate.

3. If required, click  and set the parameters.

6.10.2 TEMP & TIMER SETTINGS HELP | SET

- **Minimum Tunnel Fans On:** The minimum number of fans in tunnel entry. If enough fans do not exist for operating according to temperature, the fans with the lower temperatures will be added to reach that number. If there aren't enough fans that can operate in tunnel mode, an alarm will be activated.
- **Tunnel Exit Delay (minutes):** The time Platinum Touch / Rotem One waits after satisfying tunnel exit conditions.
- **Non brood Area Diff. From Heat:** Set point for non-brood heaters. Can be either positive or negative where **positive = warmer** and **negative = cooler**. (-99) = heaters not operating.

6.11 Vent Curtain Setup

➡ In *System > Setup*, define **Static Pressure unit** as **None**.

Use this screen to define the ventilation opening and closing mechanism. You can use one of three methods:

- Using Time to Calibrate

- Using a Potentiometer to Calibrate
- Vent/Curtain Help | Set Definitions

If you map a curtain or vent to a potentiometer, the Platinum Touch / Rotem One controller uses that method (and not time).

NOTE After defining the method used, define the opening levels in [Vent & Curtain Levels](#).

6.11.1 USING TIME TO CALIBRATE

Enter the number of seconds to open and close from limit to limit for each of the Vents and Curtains in your installation. Platinum Touch / Rotem One then calculates the percentage of open and closed time and adjusts the static pressure methods accordingly.

Vent/Curt Setup						
Curtain	Pot.	Potentiometer	Open	Close	Wind Direction	Stop Fans
Vent 1	<input type="radio"/> None	0	60	60	0	<input type="radio"/> No
Tunnel 1	<input type="radio"/> None	0	60	60	0	<input type="radio"/> No
~ Tunnel 2	<input type="radio"/> None	0	60	60	0	<input type="radio"/> No
Curtain 1	<input type="radio"/> None	0	60	60	0	<input type="radio"/> No
~ Curtain 2	<input type="radio"/> None	0	60	60	0	<input type="radio"/> No
Attic 1	<input type="radio"/> None	0	60	60	0	<input type="radio"/> No

- Define:
 - Full open/full close time (in seconds) for Curtains, Tunnel, 1st & 2nd Vent, and Attic Vent.
 - Wind direction
 - Stop fans:

NOTE Default is set at 60 seconds.

NOTE Munters recommends setting the [Help parameters](#) to maintain an accurate position.

NOTE The ~ symbol designates an analog output device.

6.11.2 USING A POTENTIOMETER TO CALIBRATE

Each curtain/vent/inlet can be mapped to a potentiometer. Potentiometer feedback enables precise positioning on each specific device opening value. In this screen, assign a potentiometer to a device.

Vent/Curt Setup						
Curtain	Pot.	Potentiometer	Open	Close	Wind Direction	Stop Fans
Vent 1	<input checked="" type="radio"/> Pot.	1	60	60	0	<input type="radio"/> No
Tunnel 1	<input checked="" type="radio"/> Pot.	2	60	60	0	<input type="radio"/> No
Curtain 1	<input checked="" type="radio"/> Pot.	3	60	60	0	<input type="radio"/> No
~ Curtain 2	<input type="radio"/> None	0	60	60	0	<input type="radio"/> No
Attic 1	<input type="radio"/> None	0	60	60	0	<input type="radio"/> No

1. In *System > Sensors > Analog*, define analog sensors as potentiometers.
2. In *System > Air Inlets Setup* map the curtain/vent/tunnel to a potentiometer. The number of devices that you can map equals the number of potentiometer relays.
3. Calibrate the potentiometer ([Ventilation Potentiometer Calibration](#)).

NOTE After calibrating the potentiometer, the times shown here change to reflect the calibration process.

In the event that the potentiometer fails (meaning there is no value change during the curtains/vents/inlets movement):

- Platinum Touch / Rotem One transmits an alarm message.
- The specific curtain/vent/inlet mapped to the failed potentiometer starts operating by time calculation, using the times calculated by the calibration process. However, if required you can enter new opening and closing times.

6.11.3 STOP FANS

Stop Fan parameter enables turning off fans if a specific curtain is moving below its minimum position. This function prevents the curtain from sticking if the static pressure is too high and curtains have not yet moved into a position which will cause the pressure to drop.

Vent/Curt Setup						
Curtain	Pot.	Potentiometer	Open	Close	Wind Direction	Stop Fans
Vent 1	<input type="radio"/> None	0	60	60	0	<input type="radio"/> No
~ Vent 2	<input checked="" type="radio"/> Pot.	1	60	60	0	<input type="radio"/> No
Tunnel 1	<input type="radio"/> None	0	60	60	0	<input type="radio"/> No
~ Tunnel 2	<input type="radio"/> None	0	60	60	0	<input type="radio"/> No
Curtain 1	<input type="radio"/> None	0	60	60	0	<input type="radio"/> No

NOTE Default is NO.

NOTE The ~ symbol designates an analog output device.

6.11.4 VENT/CURTAIN HELP | SET DEFINITIONS

These parameters enable maintaining an accurate curtain position when using time to calibrate.

Vent & Curtain Calibration			
From Time	00:00	To Time	00:00
Number Of Steps	0	Power Up Vents Calibration	<input type="checkbox"/> No
Proximity To Edge (%)	10	Close Below This Temp. (Out)	0.0

- **Define:**
 - **From/To Time:** Time period in which calibration is enabled
 - **Number of Steps:** number of steps for automatic calibration: Set calibration point for curtain after desired amount of curtain opening/closing (steps). During calibration, if the curtain is open more than 50% it opens to 100%, calibrates, and returns to the previous position. If the curtain is open less than 50% it closes to 0%, calibrates, and returns to the previous position. Default: 99.
 - **Power Vents Calibration:** This parameter enables automatic calibration of air inlets when recovering from a power outage. In many installations the backup system, such as Munters' FBU-27, may have opened the air sources. When the Platinum Touch / Rotem One takes over control again, the air inlets are incorrectly positioned. The calibration at power up feature synchronizes the actual position and the controller.
 - **Proximity to Edge %:** Curtain will open or close based on this proximity to the edge. For example, when set to 10%, the curtain closes when the opening is less than 10% and opens completely when the opening is greater than 90%.
 - **Close Below This Temp. (out):** Curtains close when the outside temperature reaches this point.
- ➔ This parameter requires defining a temperature sensor as an outside sensor (refer to Temperature Definition).

NOTE: The Proximity to Edge % parameter takes priority over the Close Below This Temp parameter. Meaning, if the outside temperature mandates closing the curtain, the curtains will still open if they are within the proximity defined in the Proximity to Edge parameter.

6.12 House Dimensions

The screen allows the user to set its' house dimensions. Set it according to the actual house size. These dimensions are used for calculating the wind chill factor (the chilling effect of the wind that can significantly lower the temperature).

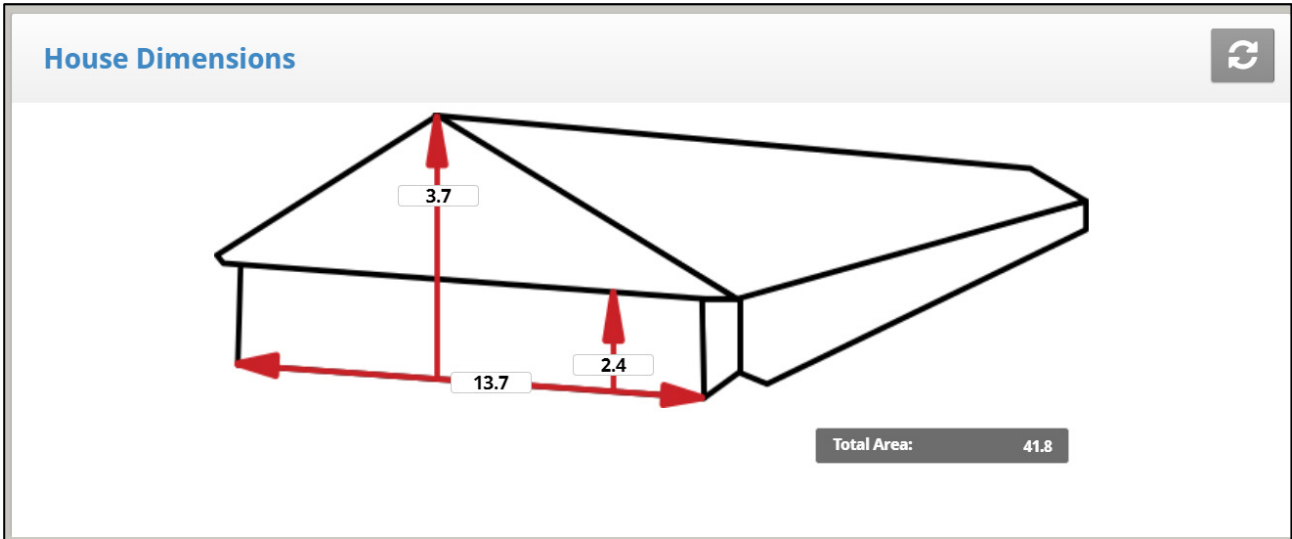

- Define height, width, and length of house (controller calculates total area).
- To set the dimensions in metric or non-metric units, go to System > Setup and scroll down to Length Unit.

6.13 Fan Air Capacity

This screen enables defining the fans' air capacity. Insert fan air capacity for both the exhaust and tunnel fans.

The screenshot shows the 'Fan Air Capacity' interface with a table listing fan types and their capacities. The table has a title bar with 'Fan Air Capacity' and icons for file, mail, and refresh. The table columns are 'Fan' and 'M3/H'.

Fan	M3/H
Tunnel Fan 1	37,500
Tunnel Fan 2	75,000
Tunnel Fan 3	112,500
Tunnel Fan 4	75,000
Tunnel Fan 5	112,500
Tunnel Fan 6	112,500
Exhaust Fan 1	54,000
Exhaust Fan 2	36,000
Exhaust Fan 3	36,000

1. In System > Relay Layout and/or System > Analog Output, define the fans.
2. In System > Setup, define the fan air capacity unit.
3. In System > Fan Air Capacity, define air capacity (default setting shown above).

NOTE This information enables the display of air capacity for each level in the Levels of Ventilation table.

6.14 Setting up a Bird Weight Curve - Summary

In Versions 7.22 or above, setting up a bird curve means defining the following items in the Scale Menu:

- [Scale Card](#): Define at least one scale.
- Gender Separated Weighing: Define if weight curves are gender separated.
 - [Non-gender separated](#) weighing provides an automatic curve, a user-customized curve, or industrial standard curves.
 - [Gender separated weighing](#) provides automatic curve, an automatic turkey curve, or a user-customized curve.
- [Bird Scale Setting](#): Define the curve type (Auto, Custom, or Factory Curve)
- [Bird Weight](#): Define the reference weight or curve data points (day and weight).

6.15 Non-Gender Based Weighing

- Scale Layout
- Bird Scale Setting
- Bird Weight

6.15.1 SCALE LAYOUT

Use Scale Layout to define the scales or silos connected to the controller.









- Scale Layout Main Screen
- Scale Layout | Set Definitions

6.15.1.1 Scale Layout Main Screen



NOTE A scale card must be installed in the controller or an RSU-2 unit must be connected to the controller for these screens to appear.

Use this screen to define the card functions. Platinum Touch/Rotem One supports the RSU-2 and two types of scale cards:

- Two channel scale cards: Supports bird scales only.
- Six channel scale cards: Supports bird, silo, and feed scales (Breeder Mode does not support feed scales). The controller can support up to ten weighing channels.
- Refer to the installation manual regarding Munters' recommendations regarding these options.

Scale Layout				
Channel	Function	No.		
Scale Card 1 Main Slot 4				
1	Scale	1		
2	Silo	1		
3	Feed Scale	1		
4	Scale	2		
5	Silo	2		
6	None	0		

6.15.1.2 Scale Layout | Set Definitions

Scale Layout - Settings  

Scale Layout

Separate Male Female

 No ▾
No
 Yes

- If male and female birds live in the same house, select No.
- If you want a separate male/female weight curve, refer to Gender Based Weighing, page 106.

6.15.2 BIRD SCALE SETTING

NOTE This screen relates to Version 7.19 and above.

 Define at least one scale, silo, or feed scale in Scale Layout.

This section describes the Bird Scale Settings for Broiler mode. Refer to Breeder and Layer Mode appendices to view the function for those modes.

- Bird Scale Setting Screen
- Bird Scale Setting | Set Definitions

6.15.2.1 Bird Scale Setting Screen

Go to System > Scale Settings > Bird Scale and elect the algorithm used to calculate the bird curve that appears in Bird Weight. There are three options:

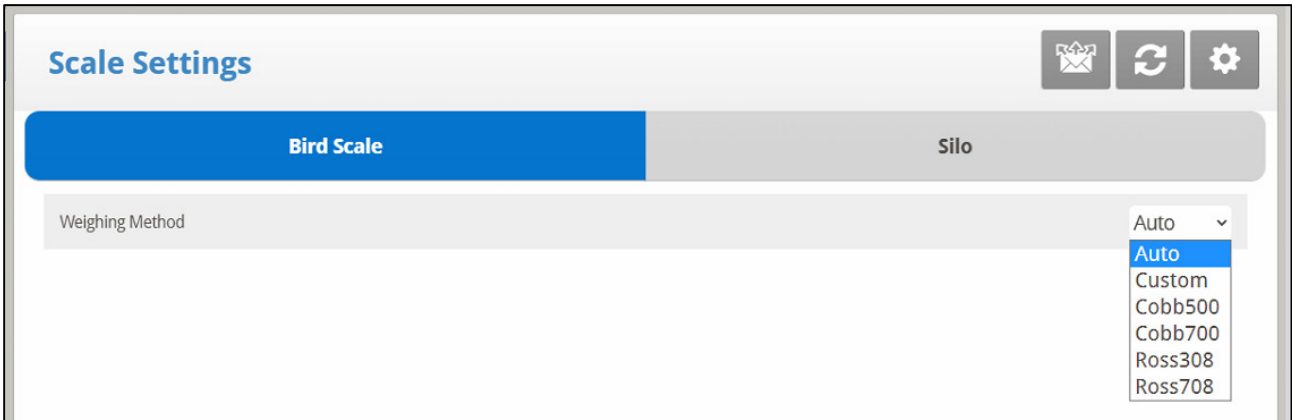

- **Auto:** Set the first target weight. The controller then automatically calculates each day's reference weight.
- **Custom:** The controller provides a weight vs growth day curve, which the user can edit as required.
- **Factory Default Curve:** The controller loads an industry standard bird curve. This curve cannot be edited.

6.15.2.2 Bird Scale Setting | Set Definitions

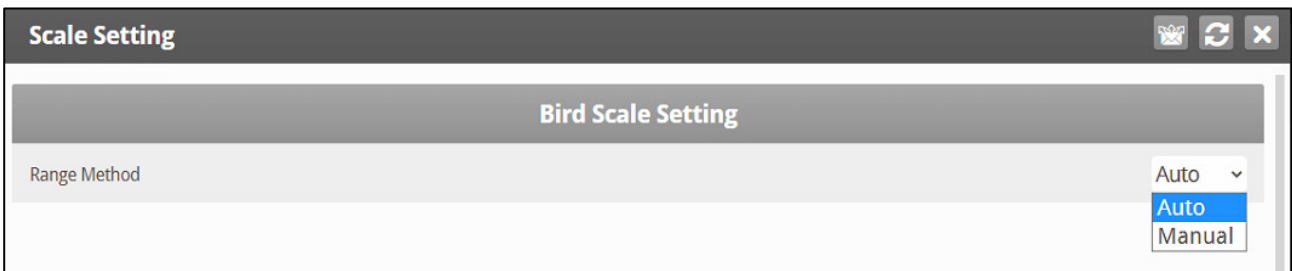

This parameter defines the range of weights that are recorded. Bird weights that are outside of the band are discarded.

- If you select Auto, Platinum Touch automatically calculates the band of acceptable weights.
- If you select Manual, define the upper and lower ranges.

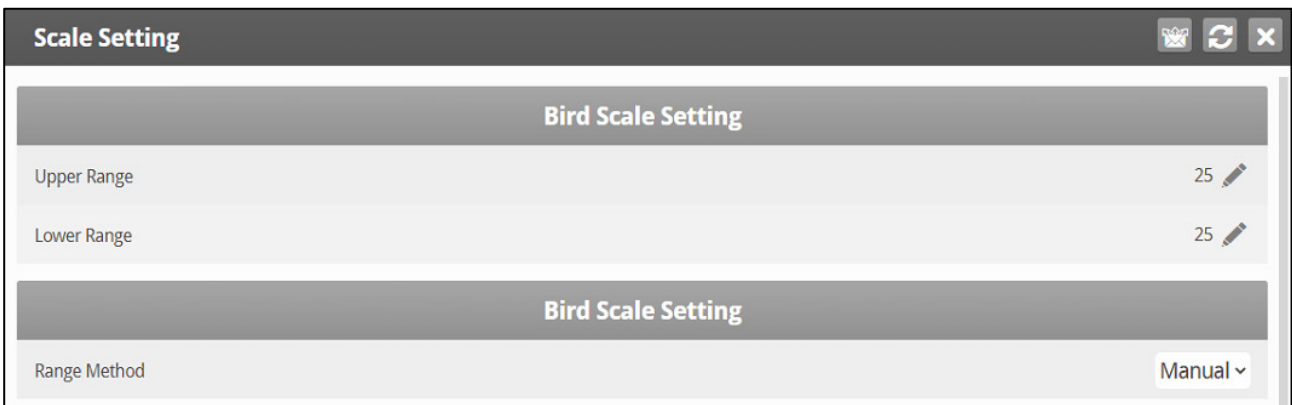

6.15.3 BIRD WEIGHT

- Bird Weight Main Screen
- Bird Weight Help | Set Definitions

6.15.3.1 Bird Weight Main Screen

In this screen, edit the bird curve selected in Bird Scale Settings.

- Go to System > Bird Curve.
 - If you selected Auto in Bird Scale, edit the weight as required. The weight is automatically adjusted.

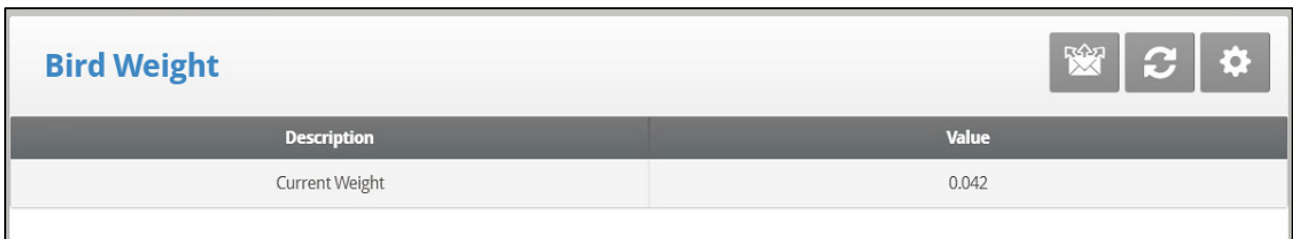

The screenshot shows the 'Bird Weight' screen with a table containing one row. The table has two columns: 'Description' and 'Value'. The 'Description' column contains 'Current Weight' and the 'Value' column contains '0.042'. There are three icons in the top right corner: a mail icon, a refresh icon, and a settings icon.

Description	Value
Current Weight	0.042

- If you selected Custom in Bird Scale, edit the curve as required.

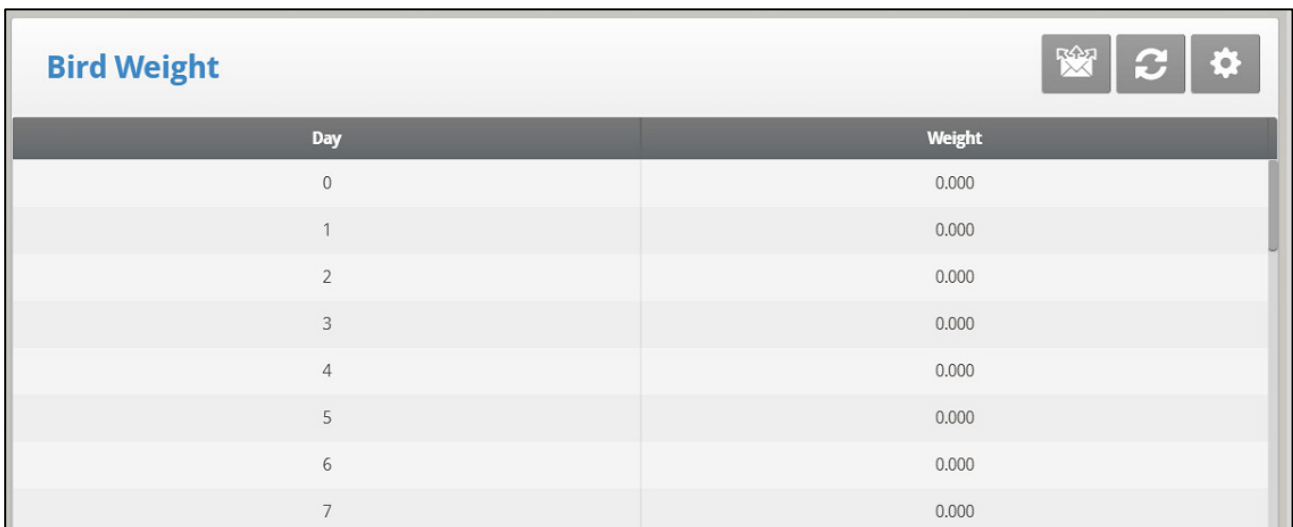

The screenshot shows the 'Bird Weight' screen with a table containing 8 rows. The table has two columns: 'Day' and 'Weight'. The 'Day' column contains values from 0 to 7, and the 'Weight' column contains the value 0.000 for each day. There are three icons in the top right corner: a mail icon, a refresh icon, and a settings icon.

Day	Weight
0	0.000
1	0.000
2	0.000
3	0.000
4	0.000
5	0.000
6	0.000
7	0.000

- If you selected an industrial standard, the curve is read only.

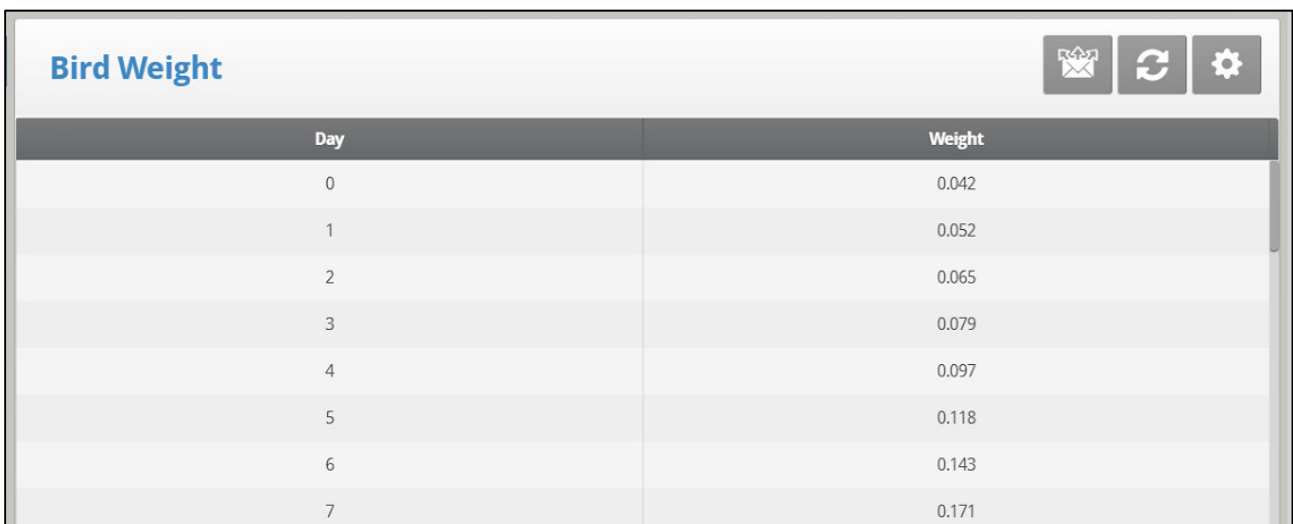

The screenshot shows the 'Bird Weight' screen with a table containing 8 rows. The table has two columns: 'Day' and 'Weight'. The 'Day' column contains values from 0 to 7, and the 'Weight' column contains values increasing from 0.042 to 0.171. There are three icons in the top right corner: a mail icon, a refresh icon, and a settings icon.

Day	Weight
0	0.042
1	0.052
2	0.065
3	0.079
4	0.097
5	0.118
6	0.143
7	0.171

6.15.3.2 Bird Weight Help | Set Definitions

NOTE This option is only available if you choose Custom or an industrial standard curve.

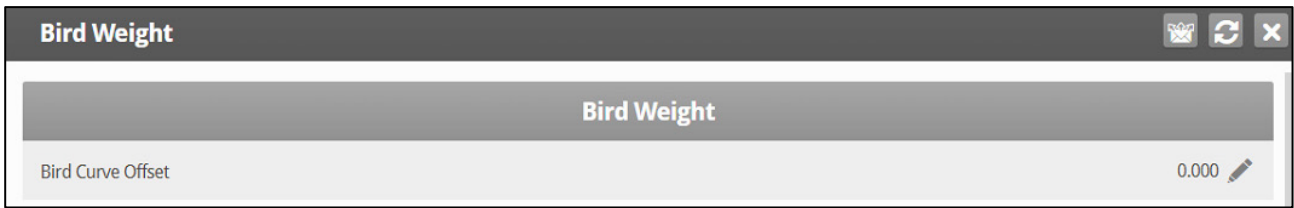

- Bird curve offset: Enter the factor used to adjust the weight curve. This amount is added to the Reference weight field. Range: 0.0 – 10.0 Kg/Lb.

6.16 Gender Based Weighing

Version 7.22 provides an option for gender-based weighing.

1. Go to System > Scale Layout > Help.

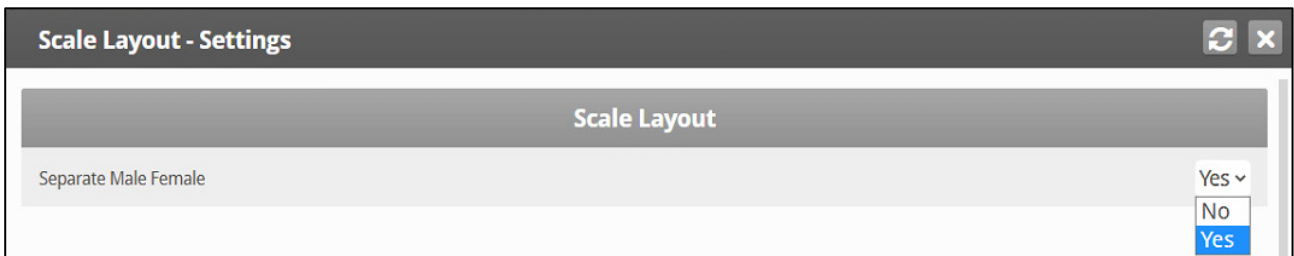

2. Select Yes.
3. Go to System > Scale Settings > Bird Scale > Help. Select Auto or Manual.

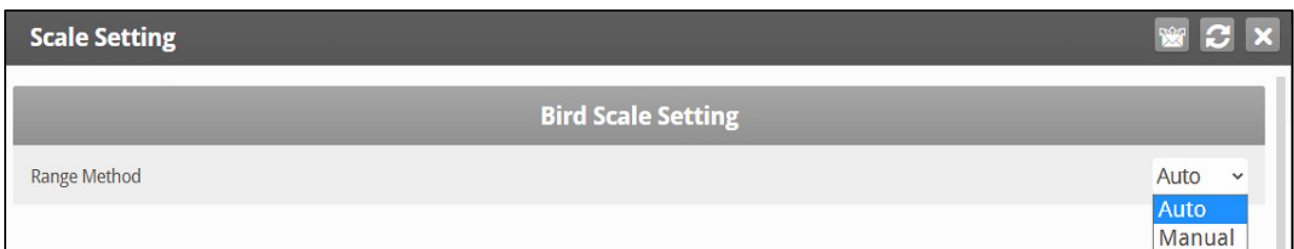

This parameter defines which measured bird weights are used in calculating the actual curve. Bird weights that are outside of the band are discarded.

- If you select Auto, Platinum Touch calculates the band of acceptable weights.
- If you select Manual, define the female/male upper and lower weight ranges.

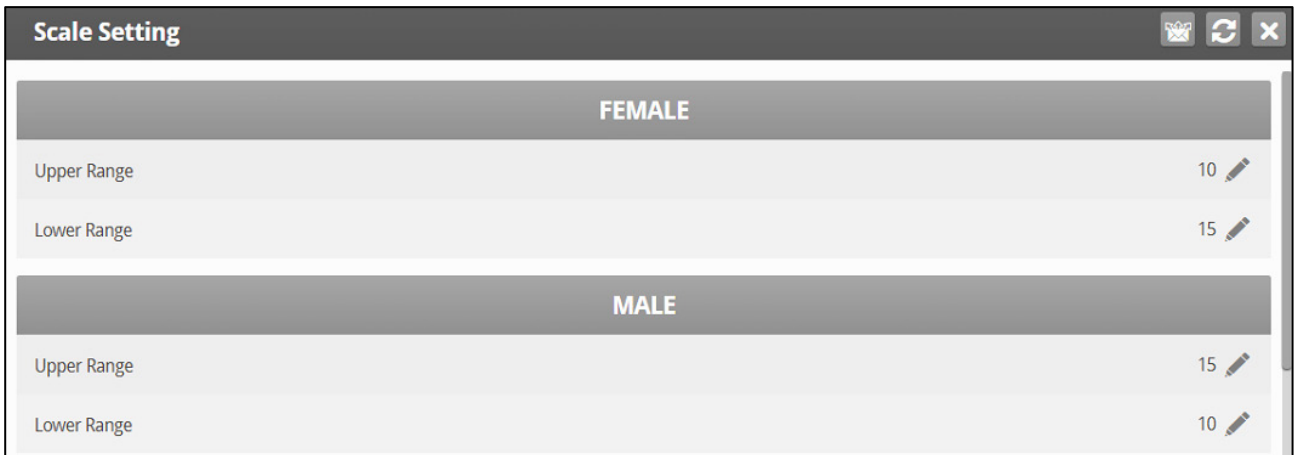

4. Go to System > Scale Settings > Bird Scale.

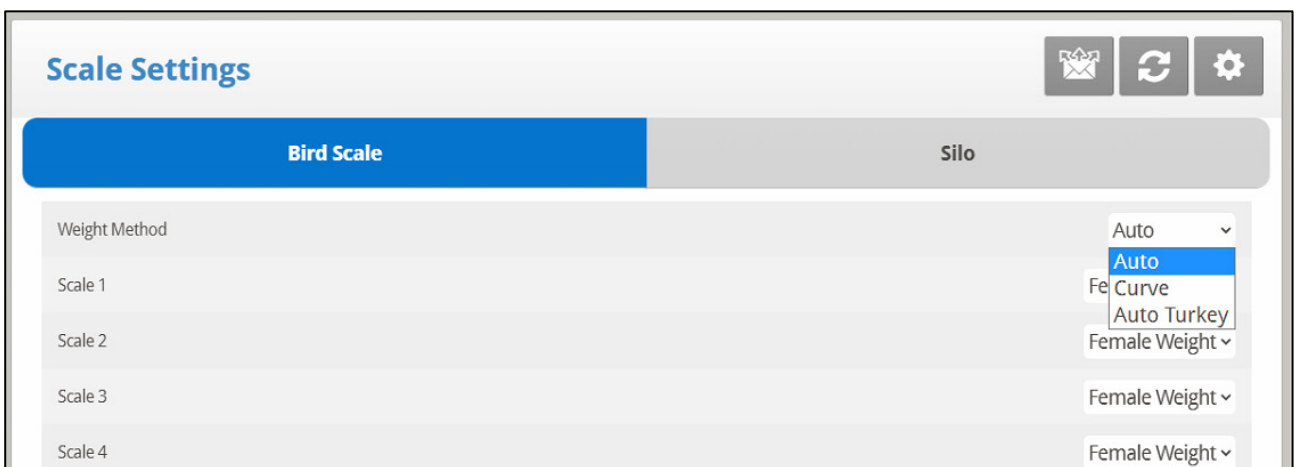

- Define the weighing method: Auto, Curve, Auto Turkey. Curve includes a user-defined curve option and industrial standard curve options.
- Define each scale as female or male.
- Version 7.24:
 - Define each scale as male, female, or male and female.
 - Define the time period during which weight data is collected

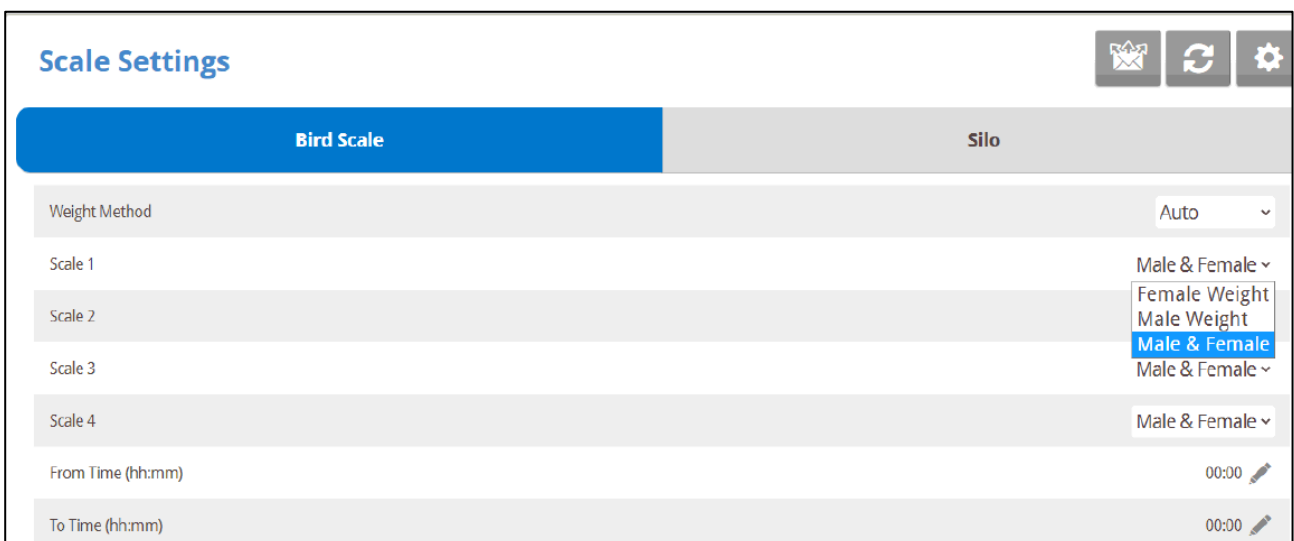

- Auto or Auto Turkey Curve

- Customized/Industrial Standard Curves

6.16.1 AUTO OR AUTO TURKEY CURVE

- Go to System > Bird Curve.
 - If you selected Auto or Auto Turkey in Bird Scale, edit the weights as required. The weight is automatically adjusted.

Bird Weight	
Description	Value
Current Female Weight	0.042
Current Male Weight	0.042

- If you selected Curve in Bird Scale, edit the curve as required.

Bird Weight		
Day	Female	Male
0	0.000	0.000
7	0.000	0.000
14	0.000	0.000
21	0.000	0.000
28	0.000	0.000
35	0.000	0.000

6.16.2 CUSTOMIZED/INDUSTRIAL STANDARD CURVES

1. Go to System > Bird Weight > Help.

Bird Weight	
FEMALE	
Bird Curve Offset	0.000
Select Curve	<div style="border: 1px solid gray; padding: 2px;"> Custom ▼ Custom Cobb500FFDarkOut Cobb500FFDarkOpenSided Cobb500FFDarkSlowDark Cobb500FFDarkSlowOpen Cobb700 Ross708F NicholasTurkeyF </div>
MALE	
Bird Curve Offset	
Select Curve	

2. For female and male, enter the factor used to adjust the weight curve. This amount is added to the Reference weight field. Range: 0.0 – 10.0 Kg/Lb.
3. For female and male, select the required curve from the drop-down list.
4. Go to System > Bird Weight.

Bird Weight		
Day	Female	Male
0	0.045	0.042
7	0.160	0.150
14	0.280	0.340
21	0.400	0.525
28	0.520	0.690
35	0.620	0.830
42	0.720	0.960
49	0.820	1.090

- If you selected Custom, you can edit the curve.
- If you selected an industrial standard curve, the curve is read-only.

6.17 Silo / Auger Layout

This menu maps augers to a specific silo. Map up to four augers to four silos (one each).

- ➔ In System > [Relay Layout](#), define relay(s) as an auger(s). Augers cannot be mapped until a relay is defined as an auger.

Silo/Auger Layout		
Silo	Auger	Device No
Silo 1	<input checked="" type="radio"/> Auger	2
Silo 2	<input checked="" type="radio"/> Auger	1
Silo 3	<input checked="" type="radio"/> Auger	3
Silo 4	<input type="radio"/> None	—

- On the screen, define each device.

NOTE Define the silo channel in [Scale Layout](#).

NOTE Define the feeding schedule in [Water & Feed](#).

6.18 Communication

Communication



Baud Rate	9600 ▾
House No.	1

This screen defines the communication parameters.

- **Baud rate:** This parameter is a measure of the communication speed for local or remote communications to a PC. The default is 9600 represents a data rate of approximately 1000 characters per second. If the connection fails at this speed, try a lower speed.



CAUTION *The baud rate used must be the same in all controllers, computers, and other devices.*

- **House number:** Each controller on a network must have a unique number (1 – 64) so Munters' communication software can distinguish individual controllers.

6.19 Scale Layout

Use Scale Layout to define the scales or silos connected to the controller. Define the weighing device attached to each channel of the scale option card.

Scale Layout



Channel	Function	No.
↳ Scale Card 1 Main Slot 4		
1	Scale ▾	1
2	Scale ▾	2
3	Silo ▾	1
4	Silo ▾	2
5	Feed Scale ▾	1
6	Scale ▾	3

7 Appendix A: Output Data

Table 1: Sensor Readings

Sensor	Definition
Temp	Displayed with the specific sensor number
Out T.	Outside temperature
Press.	Pressure
Hum. In	Inside humidity
Hum. Out	Outside humidity
Weight	Average weight
Weights	Number of weights
Breaker	Circuit breaker

Table 2: Output List (Active)

Output	Definition
Alarm	Can be either active or not. Note that this always appears last.
Heat	Indicates operating heat number
Heat. Hi	Indicates operating heat high number
Tun. Fan	Indicates operating tunnel fan number
Exh. Fan	Indicates operating exhaust fan number
Stir	Indicates operating stir fan number
Cool P.	Indicates operating cool pad number
Fogger	Indicates operating fogger number
Inlet	Mentions opening percentage
Tunnel	Mentions opening percentage
Curt.	Mentions opening percentage
Ext. Sys	Indicates operating external system number
Light	Note that these mention output percentage
Water	Indicates operating water number
Feed	Indicates operating feed number
Auger	Indicates operating auger number
Rad. Lo	Indicates operating radiant heat low number
Rad. Hi	Indicates operating radiant heat high number

Table 3: Status Readings

Status	Definition
Time	Specific time
Day	Growth day

Status	Definition
Set	Target temperature
Offset	Temperature Curve HELP SET parameter
House mode	Control Mode HELP SET parameter
Level	Level number
Tunnel, Natural, Min. Vent	The controller's state
Fan Off	How long the cycle ends its' operation
Fan On	How long the cycle begins its' operation
Curve off	Occurs when located in low curve temperature or when the Control Mode HELP SET 'Temperature Curve' parameter is set to OFF.
Hum. Treat	Indicates when treatment occurs
Cool flush	Indicates when flush occurs
Nip. Flush	Indicates when flush occurs

Table 4: Table of Events

Event	Event Explanation
Power Off	Appears when power is off
Power On	Appears when power is on
Cold Start	Appears when cold start is done
Change level to vent	Changes according to a specific stage
Backup set reminder	HELP SET: 'Set Temp. Change remainder (diff)' parameter
Alarm on	Appears when the alarm is on
Change in setting	
Change in switches	Relay switch setting changed
New flock	Appears when new flock is updated
Reset alarm	Appears when reset alarm is done
System message #	For Munters' technicians only
Alarm card fail	Appears when the alarm card fails
Digital card fail	Appears when the digital card fails
Memory restore	Appears when the system does restore cause by noises
Minimum ventilation	Appears when minimum ventilation occurs
Natural ventilation	Appears when entering natural ventilation
Tunnel ventilation	Appears when entering tunnel ventilation
Alarm test	Appears when alarm test completes
Precision Mode	Switch to Precision Mode
Standard Mode	Switch to Standard Mode
Changed growth day	Appears when changing the growth day occurs
MinV L.P Alarm Dis.	Appears when minimum low-pressure alarm is disabled
MinV L.P Alarm Ena	Appears when minimum low-pressure alarm is enabled
Tun. L.P Alarm Dis.	Appears when tunnel low pressure alarm is disabled
Tun L.P Alarm Ena.	Appears when tunnel low pressure alarm is enabled

Event	Event Explanation
Visitor Log in	Appears when the visitor logs in with his password
User #1-5 log in	Appears when the user logs in with his password
Owner log in	Appears when the owner logs in with his password
Change Visitor pass	Appears when the visitor changed his password.
Change User #1-5 pass	Appears when the user changed his password
Change Owner pass	Appears when the owner changed his password
Data read from plug	Appears when data is read from plug
System recover	Appears when the system tries to recover itself, in cases such as noises
System lock	Appears when either using the correct password, or when using hot key '9,' or automatically after 5 minutes
Empty house mode	Appears when setting at a specific time
Version 7.23	
Ref Weight Change	Appears when Curve Offset is manually changed in Scale>Bird Weight>Settings. Change can be a different curve, gender, or offset.
Factor Change	Appears when Factor is manually changed in Scale>Calibration
Scale or Silo Calibration	Appears when silos/scales are manually calibrated in Scale>Calibration

8 Appendix B: Natural Ventilation

Version 7.14 supports Natural Ventilation. The following section details the setup and theory.

- Natural Ventilation Setup
- Theory of Operation

8.1 Natural Ventilation Setup

1. Go to System > Setup.

The screenshot shows the 'Setup' page with various configuration options. The 'Natural Ventilation' setting is highlighted with a blue box and set to 'Yes'. Other settings include Temperature Unit (F°), Pressure Unit (IN.W.C), Wind Speed Units (Feet/Min), Fan Air Capacity Unit (CFM), Length Unit (Non Metric), Weight Unit (LB), Growing Zones 1-4 (1), Minimum Ventilation (Power) (Yes), and Tunnel (Yes). The History Resolution is set to 1 Hour.

2. Set Natural Ventilation to YES.

3. Go to Installation > Relay.

The screenshot shows the 'Relay Layout' page with a table of relay configurations. The table has columns for Relay No., Device, No., and N.C. The 'N.C.' column contains checkboxes. The table is expanded to show 'Card 3 Main Slot 3'.

Relay No.	Device	No.	N.C.
↳ Card 3 Main Slot 3			
21	Curtain Open	3	<input type="checkbox"/>
22	Curtain Close	3	<input type="checkbox"/>
23	Curtain Open	4	<input type="checkbox"/>
24	Curtain Close	4	<input type="checkbox"/>
25	Feeder	2	<input type="checkbox"/>
26	Auger	2	<input type="checkbox"/>
27	Feeder	4	<input type="checkbox"/>
28	Feeder	3	<input type="checkbox"/>
29	Water	3	<input type="checkbox"/>

4. Define relays as Curtain Open and Curtain Close (up to four each) (for details refer to Relay Layout, page 90).

5. Go to System > Temperature Device Settings (option).

Temperature Definition					
Function	Sensors				
	2	3	4	5	6
Attic	<input type="checkbox"/>	<input type="checkbox"/>	<input type="checkbox"/>	<input type="checkbox"/>	<input type="checkbox"/>
Outside	<input type="checkbox"/>	<input type="checkbox"/>	<input type="checkbox"/>	<input type="checkbox"/>	<input type="checkbox"/>
Heat 1	<input type="checkbox"/>	<input type="checkbox"/>	<input type="checkbox"/>	<input type="checkbox"/>	<input type="checkbox"/>
Stir Fan 1	<input type="checkbox"/>	<input type="checkbox"/>	<input type="checkbox"/>	<input type="checkbox"/>	<input type="checkbox"/>
~ Stir Fan 2	<input type="checkbox"/>	<input type="checkbox"/>	<input type="checkbox"/>	<input type="checkbox"/>	<input type="checkbox"/>
Cool Pad 1	<input type="checkbox"/>	<input type="checkbox"/>	<input type="checkbox"/>	<input type="checkbox"/>	<input type="checkbox"/>
Fogger 1	<input type="checkbox"/>	<input type="checkbox"/>	<input type="checkbox"/>	<input type="checkbox"/>	<input type="checkbox"/>
Curtain 1	<input checked="" type="checkbox"/>	<input type="checkbox"/>	<input type="checkbox"/>	<input type="checkbox"/>	<input type="checkbox"/>
~ Curtain 2	<input type="checkbox"/>	<input type="checkbox"/>	<input checked="" type="checkbox"/>	<input type="checkbox"/>	<input type="checkbox"/>
Curtain 3	<input type="checkbox"/>	<input type="checkbox"/>	<input type="checkbox"/>	<input checked="" type="checkbox"/>	<input checked="" type="checkbox"/>
Curtain 4	<input type="checkbox"/>	<input checked="" type="checkbox"/>	<input type="checkbox"/>	<input type="checkbox"/>	<input type="checkbox"/>

6. Assign specific temperature sensor(s) to each curtain (for details refer to Temperature Definition, page 95).

NOTE: If you do not assign a sensor to a curtain, the house temperature determines the curtain's natural ventilation functionality.

7. Go to System > Vent/Curtain Setup.

Vent/Curt Setup						
Curtain	Pot.	Potentiometer	Open	Close	Wind Direction	Stop Fans
Vent 1	<input checked="" type="radio"/> Pot.	1	60	60	0	<input type="radio"/> No
Tunnel 1	<input checked="" type="radio"/> Pot.	2	60	60	0	<input type="radio"/> No
Curtain 1	<input checked="" type="radio"/> Pot.	3	60	60	0	<input type="radio"/> No
~ Curtain 2	<input type="radio"/> None	0	60	60	0	<input type="radio"/> No
Curtain 3	<input type="radio"/> None	0	60	60	0	<input type="radio"/> No
Curtain 4	<input type="radio"/> None	0	60	60	0	<input type="radio"/> No
Attic 1	<input type="radio"/> None	0	60	60	0	<input type="radio"/> No

8. Define the curtains opening and closing times (for details refer to Vent Curtain Setup, page 97).

9. Go to System > Vent/Curtain Setup > Help (option).

Vent/Curt Calibration

Vent & Curtain Calibration

From Time	00:00	To Time	00:00
Number Of Steps	0	Power Up Vents Calibration	<input type="radio"/> No
Proximity To Edge (%)	10	Close Below This Temp. (Out)	0.0

10. Set the parameters as required (refer to Vent/Curtain Help | Set Definitions, page 100 for details).

11. Go to System > Temperature & Timer.

Temperature & Timer Settings

Device	On	Off	MNT			Option
			Min Vent	Natural	Tunnel	
Cool Pad 1	31.7	31.1	<input type="checkbox"/>	<input type="checkbox"/>	<input checked="" type="checkbox"/>	None ▾
* Tunnel Fan 4	31.1	29.4	<input type="checkbox"/>	<input type="checkbox"/>	<input checked="" type="checkbox"/>	None ▾
* Tunnel Fan 3	31.1	29.4	<input type="checkbox"/>	<input type="checkbox"/>	<input checked="" type="checkbox"/>	None ▾
* Tunnel Fan 2	31.1	29.4	<input type="checkbox"/>	<input type="checkbox"/>	<input checked="" type="checkbox"/>	None ▾
* Tunnel Fan 1	31.1	29.4	<input type="checkbox"/>	<input type="checkbox"/>	<input checked="" type="checkbox"/>	None ▾
Tunnel Setting	31.1	29.4	<input type="checkbox"/>	<input type="checkbox"/>	<input type="checkbox"/>	▾
* Curtain Open 4	29.4	28.3	<input type="checkbox"/>	<input checked="" type="checkbox"/>	<input type="checkbox"/>	▾
* Curtain Open 3	29.4	28.3	<input type="checkbox"/>	<input checked="" type="checkbox"/>	<input type="checkbox"/>	▾
* Curtain Open 2	29.4	28.3	<input type="checkbox"/>	<input checked="" type="checkbox"/>	<input type="checkbox"/>	▾
* Curtain Open 1	29.4	28.3	<input type="checkbox"/>	<input checked="" type="checkbox"/>	<input type="checkbox"/>	▾
Fogger 1	28.3	27.8	<input checked="" type="checkbox"/>	<input type="checkbox"/>	<input type="checkbox"/>	None ▾

12. Define:

- Natural Setting: The temperature at which natural ventilation begins.

NOTE: This parameter determines when Platinum enters and exits Natural Ventilation. The temperature sensors and curtain on/off parameters determine how the curtains operate in Natural Ventilation.

- Each curtain's operational temperature (Curtain On/Off)
- In which ventilation mode the curtains operation (Minimum Ventilation (M), Natural (N), Tunnel (T)).
- Refer to Temp & Timer Setting, page 96 for details.

CAUTION If all MNT functions are disabled on a curtain, the curtain never the less functions in all three modes. At least one mode must be enabled to disable other modes.

13. Go to System > Temperature & Timer > Settings.

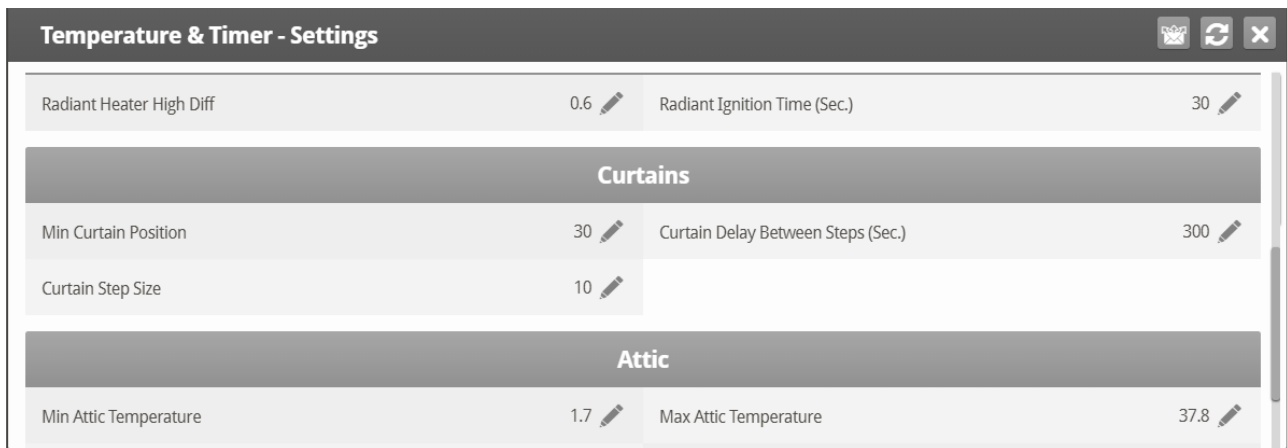

14. Set the curtain parameters as required:

- Minimum Position %: This is the smallest curtain opening in Natural Ventilation Mode. Range: 0 – 100%. Default: 30%.
- Delay Between Steps (seconds): Delay in time between each curtain movement. Range: 0 – 999. Default: 300.
- Step Size %. The change in the curtain's position at each step. Note that when closing, the change will never place the curtain below the minimum position.

8.2 Theory of Operation

Natural Ventilation enables supplying the house's air requirements using the wind. While in this mode, up to four curtains open and close based on temperature only (meaning, other factors such as humidity, wind direction or speed don't have any effect). In addition, ventilation via static pressure is disabled.

- Transition to or from Natural Ventilation
- Curtain Movement
- Toggle Switches

8.2.1 TRANSITION TO OR FROM NATURAL VENTILATION

Platinum enters Natural Ventilation when the temperature is above the Natural Setting On temperature (see Step 12 above). At that point, the actual curtain operation (how far they open, how many steps, etc.) is controlled by the temperature sensors (see Step 5 above).

- When Platinum goes from Minimum or Tunnel Ventilation to Natural:
 - Any fan not designated as working in Natural (in Temp & Timer Settings) will stop operating. In the screen shown in Step 11 Tunnel Fans 1, 3, and 4 cease to operate.
 - Vent or tunnel curtains close to 0%.
 - Natural curtains:
 - When going from Minimum Ventilation to Natural, curtains open to their minimum position (20% in Step 13).
 - When going from Tunnel Ventilation to Natural, curtains open to 100% and then re-adjust themselves according to the curtain steps and temperature.

- If a curtain that is currently open is designated to work in Natural and either Minimum or Tunnel mode, the curtain remains in place.

Platinum exits Natural Ventilation when the temperature is below the Natural Setting Off temperature (see Step 12 above).

- When Platinum goes from Natural Ventilation to Minimum or Tunnel Ventilation to
 - Any fan designated as working only in Natural (in Temp & Timer Settings) will stop operating. In the screen shown in Step 11 Tunnel Fan 2 shuts down.
 - Vents or tunnel curtains open to their minimum positions
 - Natural curtains:
 - Any curtain designated to work only in Natural Ventilation mode closes. In the screen shown in Step 11 Curtain 1 closes.
 - If an open curtain is designated to work in Natural and either Minimum or Tunnel mode, the curtain remains in place. However, if the temperature is below the Natural Setting Off temperature, curtains move to their minimum position.
 - Control mechanisms such as static pressure only begin to function when the transition is completed.

8.2.2 CURTAIN MOVEMENT

When in Natural Ventilation mode

- If the temperature is above a curtain's ON temperature, the curtain opens after the delay time according to the amount specified in the step size (Step 13 above). After each step, the curtain waits the delay time before any further opening.
- If the temperature is below a curtain's OFF temperature, the curtain closes after the delay time according to the amount specified in the step size (Step 13 above). However, the curtain will not go below the minimum opening position.
- When the temperature is between the On and Off temperatures, the curtain remains in place.

8.2.3 TOGGLE SWITCHES

All the information above assumes that the curtains' relay switches are set to Automatic. If the user moves a curtain's open relay toggle switch to ON:

- If the curtain was opening at the time, Platinum will use the curtain's current position for all calculations when the toggle switch is reset to Automatic. For example, if the curtain is 75% open when the switch is reset to Automatic, Platinum uses that position as the curtains starting point.
- If the curtain was closing at the time, the curtain reverses its movement and begins to open. However, when the toggle switch is reset to Automatic, the curtain returns to its previous position. For example if the curtain had gone down to 45% open when the toggle switch was set to On, it will return to 45% when the switch is reset to Automatic.

9 Appendix C: Device Setup Summary

The following section summarizes how to setup up different devices in Platinum Pro.

- Stir Fans
- Attic Ventilation
- Heaters Control

9.1 Stir Fans

Stir fans mix the air, to maintain a uniform temperature throughout the house. It does this by mixing (recycling) warmer air with the rest of the house (back down across the floor).

1. In *System > Relay Layout* and/or *System > Analog Output*, define relays as stir fans.
2. In *System > Temperature & Timer*, define the parameters as required.
3. In *System > Temperature & Timer > Help*, define the Stir Fan parameters as required.
4. In *System > Temperature Definition*, map a temperature sensor to a stir fan.

9.2 Attic Ventilation

Attic fans maximize the amount of fresh air in cold weather by utilizing warm air found near the ceiling. Air entering via the attic inlets tends to become warmer and drier than the outside air.

NOTE: *Munters recommends operating the attic vents at static pressures lower than the vent inlets.*

1. In *System > Relay Layout*, define relays as attic open and attic close.
2. In *System > Temperature Definition*, map a temperature sensor to the attic.
3. In *System > Vent/Curtain Setup*, define the attic parameters as required.
4. In *System > Temperature & Timer*, define the parameters as required.
5. In *System > Temperature & Timer > Settings*, define the Stir Fan parameters as required.

9.3 Heaters Control

Regular and Radiant Heaters Control is based on the following settings:

1. In *System > Relays* select the heating devices.
2. In *System > Temperature Definitions* map a temperature sensor to each heating device.

NOTE: *If a heater shares the same temperature sensor with a brood sensor, Platinum One assigns the heater automatically to Brood Area and operates accordingly.*

3. In *System > Temperature & Timer* define the heating parameters as required.

- On Temp specifies the Heater On temperature (always below or equal to set temperature)
- Off Temp specifies the Heater Off temperature (could be higher than the Set temperature.)

4. In *System > Temperature & Timer > Settings* define the Non-Brood Area Difference Below Heat and Radiant Heater Specs as required.

Notes:

- When regular heater is activated, the low-pressure alarm is disabled since heaters produce positive static pressure.
- Heater Off Temperature must be at least 0.5° F higher than the Heater On Temperature.
- Heater On Temperature must be equal or less than the Set Temperature.

10 Appendix D: Keyboard Functions

There are several functions which must be configured using the keyboard found on the inside door. This section details those functions.

- Service Menu
- Management Menu
- Test Menu

10.1 Service Menu

The Service Menu items calibrate various Platinum Touch / Rotem One functions.

- Temperature Calibration
- Humidity Calibration
- CO2 Sensor Calibration
- Static Pressure Calibration
- Light Sensor Calibration
- Feed Calibration
- Water Calibration
- Ventilation Potentiometer Calibration
- Nipple Flushing
- Feeders & Drinkers
- Save Settings
- Load Settings
- Load Settings Report
- Current Sense Relay Calibration
- Wind Direction Calibration
- WOD Calibration
- Ammonia Calibration

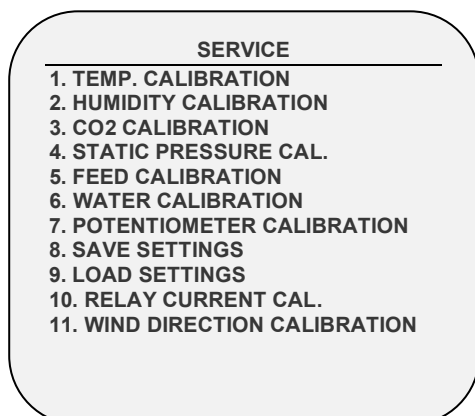

10.1.1 TEMPERATURE CALIBRATION

The Platinum Touch / Rotem One temperature sensors are typically accurate to approximately 0.5° F within the range of temperatures for poultry production. Calibrate them in this menu by adding/subtracting a constant correction factor to each sensor. Adjust the sensor of your choice with the left/right arrow keys.

TEMPERATURE CALIBRATION		
Sensor	Temp°	Factor
1	78.2	1.6
2	86.4	0.9
3	83.0	-1.5
4	86.2	0.8
5	85.2	-1.6
6	84.2	0.0

Calibrating against infrared or in air temperature sensors generally results in less accuracy than the basic sensors have without calibration.

CAUTION Only calibrate the sensors if you have reason to believe that they are producing inaccurate results.

To calibrate the sensor:

1. Obtain an accurate reference sensor and a pail of water at the approximate required temperature.
2. Stir the reference sensor together with the Platinum Touch / Rotem One sensor vigorously in the bucket of water. Keep your hands off the sensor itself, so that it responds accurately to the water temperature. Stirring is necessary to preclude stratification within the bucket of water.
3. Call out the accurate reading to a second person standing at the Platinum Touch. Walkie-talkie radios may be a good idea.
4. The individual at the controller should double-check that you are calibrating the correct sensor. You might warm/cool the sensor temporarily to see which sensor changes temperature appropriately.
5. Once you determine the correct temperature and allow approximately one minute for stabilization in the water, adjust the sensor reading at the controller.
6. Offset the factor using the left/right arrow keys.

10.1.2 HUMIDITY CALIBRATION

To calibrate the humidity level, obtain a suitable humidity test kit and use the procedures described there. They are commonly available via the Internet.

CAUTION Only calibrate the sensors if you have reason to believe that they are producing inaccurate results.

HUMIDITY CALIBRATION		
Sensor	Humidity°	Factor
In-1	58.9	2.3
Out	N/A	---

Press Left/Right Arrows to Calibrate

- Adjust the Platinum Touch / Rotem One reading as needed using the left/right arrow keys.

10.1.3 CO2 SENSOR CALIBRATION

To calibrate the CO2 level, obtain a suitable test kit and use the procedures described in the kit. Ensure that the house is well ventilated, either naturally or using fans.

CAUTION Only calibrate the sensors if you have reason to believe that they are producing inaccurate results.

CO2 SENSOR CALIBRATION	
	Value
PPM at 4 mA/1 VDC	26
PPM at 20 mA/5 VDC	3000
Factor (PPM)	22

CO2 (ppm):
482

- Ppm at 4 mA / 1 VDC: Parts per million for 4 mA or 1 VDC
- Ppm at 20 mA / 5 VDC: Parts per million for 20 mA or 5 VDC
- Factor (ppm): (-/+) ppm shift from the current reading
- CO2 (ppm): Current CO2 readings
- Adjust the Platinum Touch / Rotem One reading as needed using the left/right arrow keys.

10.1.4 STATIC PRESSURE CALIBRATION

The Static Pressure should be 0 when there is no ventilation and the house is closed. When the controller A/D counts is 100, this means that there is zero (0) static pressure.

CAUTION The Static Pressure sensor is factory calibrated. Only calibrate the sensor if you have reason to believe that they are producing inaccurate results.

NOTE Run Platinum Touch / Rotem One for a few hours so that the temperature in the box becomes stable and only then calibrate.

CAUTION DO NOT blow the air into the hose to see if the pressure changes! The sensor is sensitive and blowing air can cause irreparable damage.

To calibrate the Static Pressure Sensor:

1. Disconnect the air hoses.
2. Go to *Service > Static Pressure Cal.*
3. If the A/D count is 100 +/- 30 (70 to 130), press Enter.
4. If the A/D count is less than 70 or greater than 130:

- a. Check for blocked air hoses or wind interference.
- b. Adjust the zero-pressure reading to approximately 100 by turning the calibration screw.
- c. When the A/D count is within the permitted range, press **Enter**.

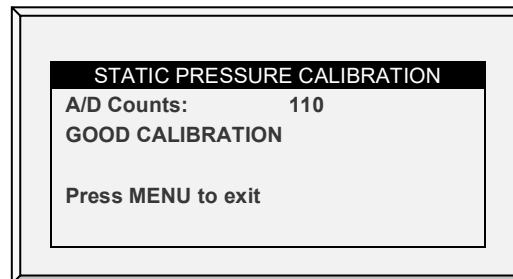
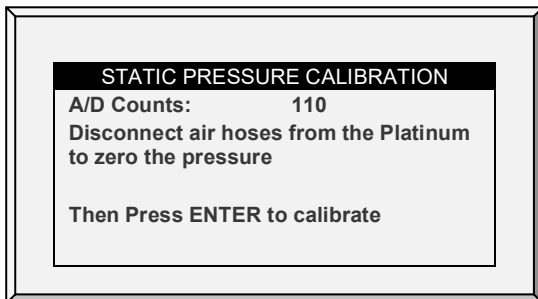

The static pressure sensor is located inside the controller in the upper left corner to the left of the power supply.

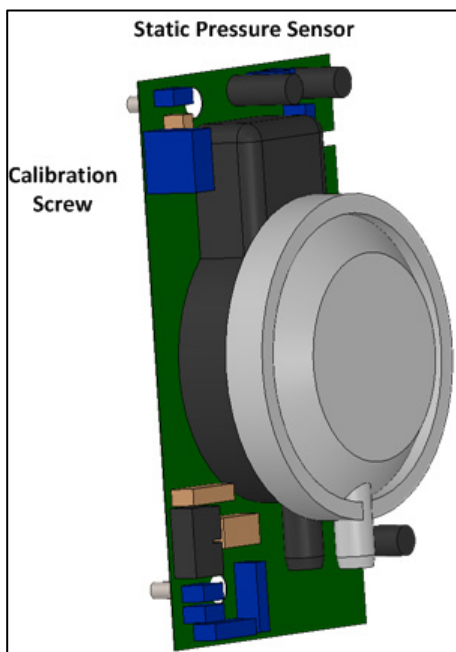

10.1.5 LIGHT SENSOR CALIBRATION

NOTE Broilers mode supports this feature.

Installing a light sensor enables turning off the lights when there is sufficient outside light.

To calibrate the light sensor:

1. Go to *System > Analog Sensors*.
2. Define one sensor as a light sensor.
3. Go to *Management > Light*.
4. Press **Help**, highlight **Set**, and press **Enter**.
5. Scroll down to **Light Sensor Active** and set to **Yes**.
6. Place the sensor in the required location.
7. Go to *Service > Light Sensor Calibration*.

8. When the outside light is bright enough, press **Enter**.

10.1.6 FEED CALIBRATION

- Platinum Touch / Rotem One can use silo scales or less expensive digital monitoring devices to keep track of your feed. This menu calibrates the digital monitoring devices.
1. Select the feed counting method. Your digital monitoring device may generate a dry contact pulse for each quantity of feed, or it may simply indicate that the feed is running.
 2. Enter the quantity of feed per pulse in case you use a dry contact pulse. Otherwise, enter the amount of feed delivered per minute of auger operation.
 3. Select one of the following:
 - Pulse: Weight per pulse
 - Time: Weight per minute
 - Current Sense: Motor run time when the auger contains feed
 4. Enter quantity (weight per minute or per pulse).

FEED CALIBRATION				
Feed	1	2	3	4
Method	TIME	TIME	TIME	TIME
Factor	2.203	2.203	2.203	2.203

Method Pulse: Weight per Pulse
 Method Time: Weight per Minute
 Method Current: Weight per Minute

10.1.7 WATER CALIBRATION

Platinum Touch / Rotem One supports up to four dry contact pulse output water meters. Enter the quantity of water per pulse for your water meters.

WATER CALIBRATION			
Water 1	-	Water Per Pulse	0.100
Water 2	-	Water Per Pulse	0.100
Water 4	-	Water Per Pulse	0.100
Water 4	-	Water Per Pulse	0.100
Cool Pad	-	Water Per Pulse	2.203
Fogger	-	Water Per Pulse	2.203

10.1.8 VENTILATION POTENTIOMETER CALIBRATION

Use this screen to calibrate the ventilation potentiometer control. Potentiometer calibration is required before ventilation can be controlled via a potentiometer.

POTENTIOMETER CALIBRATION				
Pot	Device	Close	Current	Open
1	Vent 1	152	0	1000
2	Vent 2	152	0	1000

➤ **Before calibrating the potentiometers:**

- Disable the static pressure unit in *System > Setup*.
 - Define at least one relay as vent/inlet/tunnel in *System > Relay Outlet*.
 - Define at least one analog sensor as a potentiometer in *System > Analog Sensor*.
1. Select a potentiometer number.
 2. Press Enter.
 - The device relay closes and then opens. As this takes place, the numbers in the Close, Current, and Open columns change. After a few minutes, the process completes and a "Good Calibration" message appears.

NOTE After potentiometer calibration, the times displayed in the Vent/Curtain Setup screen change.

10.1.9 NIPPLE FLUSHING

NOTE Broiler Mode supports this function.

To use this selection, program the water solenoids using the following relay codes:

- **111 Water Main:** The control's supplementary for the usual water line
- **112 Water Bypass:** The control's supplementary to bypass the water pressure regulator
- **113 Water line 1 through 122 Water line 10:** Individual water line supplementary to select the line to flush

During normal operation, only relay 111 water main is active. During flushing relay, code 112 is active together with each of the individual water line relays in turn.

- Configure up to 20 flush times.
- Set start time/duration of water flushing (water lines as defined by relay layout)

NIPPLE FLUSHING		
Start Time	On Time (min)	Status
06:00	2	AUTO
15:40	1	AUTO
00:00	0	AUTO
00:00	0	AUTO
00:00	0	AUTO

10.1.9.1 Nipple Flushing Help | Set Definitions

② While viewing the Nipple Flushing menu: Press **HELP**, select **SET** and press **ENTER**.

FLUSH ORDER							
Line:	1	2	3	4	--	--	--
Order:	1	2	3	4	--	--	--

FLUSHING DAYS							
Day:	Sun	Mon	TUE	WED	THU	FRI	SAT
Flush:	▪	√	√	▪	▪	▪	▪

- Flush Order: Set flushing according to line/order
- Flushing Days: Set flushing per day

10.1.10 FEEDERS & DRINKERS

This selection enables inserting relevant information regarding feeder and drinker lines.

FEEDERS AND DRINKERS			
Day	Window Pos (%)	Feeder-Line Lift (inch)	Drinker-Line Lift (inch)
15	90	0.0	14.0
20	50	15.0	3.0
0	0	0.0	0.0
0	0	0.0	0.0
0	0	0.0	0.0
0	0	0.0	0.0
0	0	0.0	0.0

- Day: Insert day number.
- Window Pos (%): Insert the percentage of window's position.
- Feeder-Line Lift (Inch): Define the specific feed line lift, measured in inches.
- Drinker-Line Lift (Inch): Define the specific drinker line lift, measured in inches.

10.1.10.1 Feeders & Drinkers Help | Set Definitions

② While viewing the *Feeders and Drinkers* menu: Press **HELP**, select **SET** and press **ENTER**.

FEEDERS AND DRINKERS	
Adjust At Time	12:00
FEEDER WINDOW	
Stop Feed Before Adjust (Min.)	60
Time From Close To Open (sec)	15
FEED LINE	
Movement Time Per 10 inch (sec)	0
DRINKERS LINE	
Movement Time Per 10 inch (sec)	0

- Adjust at Time: Set the desired time to adjustment.

Feeder Window

- **Stop Feed Before Adjust (min):** Set the amount of time to stop feeding before adjustment begins.
- **Time from Close to Open (sec):** Set the amount of time after stopping the feeding before opening the feeder's window.

Feed Line

- **Movement Time per 10 inch (sec):** Set the number of seconds needed to move the feed line 10 inches.

10.1.11 SAVE SETTINGS

This menu enables the user to save the program settings to an SD card and transport them to another controller.

NOTE If both a data plug and SD card are inserted, the data plug takes priority and that option appears on the screen.

- Verify that the SD card is in place.
- The SD card must have at least 20K of free space.

To save settings:

1. Go to Service > Save Settings.
2. In the screen that appears, select YES and press Enter.
3. Select the required settings and press Enter.
4. Wait for the settings to download.



SAVE TO SD CARD		
1. Setting #1	8-Jan-13	12:00
2. Setting #1	15-Jan-13	12:00
3. Setting #1	23-Mar-13	12:00
4. Setting #1	15-Jun-13	12:00
5. Setting #1	15-Nov-13	12:00
6. Setting #1	01-Jan-14	12:00

10.1.12 LOAD SETTINGS

This menu enables the user to load settings saved on an SD card into a controller.

- Verify that the SD card is in place.
- The SD card must have at least 20K of free space.

To load settings:

1. Go to Service > Load Settings.
2. In the screen that appears, select YES and press Enter.
3. Select the required settings and press Enter.
4. Wait for the settings to upload.

READ FROM SD CARD		
1. Setting #1	8-Jan-13	12:00
2. Setting #1	15-Jan-13	12:00
3. Setting #1	23-Mar-13	12:00
4. Setting #1	15-Jun-13	12:00
5. Setting #1	15-Nov-13	12:00
6. Setting #1	01-Jan-14	12:00

10.1.13 LOAD SETTINGS REPORT

NOTE Version 7.19 and above supports this function.

When uploading settings to a controller, Platinum Touch/Rotem One lists which tables (if any) will not be transferred. Compatibility issues might arise in cases when transferring settings between controllers using different software versions or having different configurations. By listing which tables will not transfer, the user knows which tables must be defined manually.

1. Go to Service > Load Settings.
2. In the screen that appears, select YES and press Enter.
3. Select the required settings and press Enter.
4. If there are any incompatible tables, a list of the pathways appears.

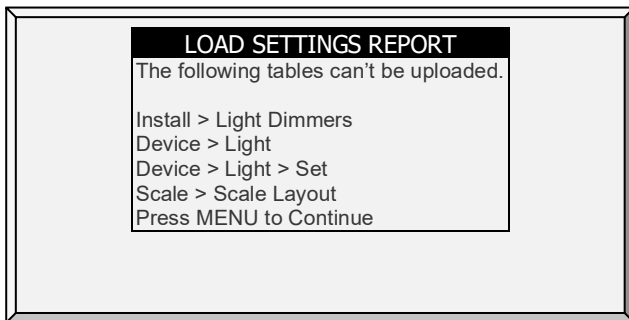

5. Press Menu. The following message appears:

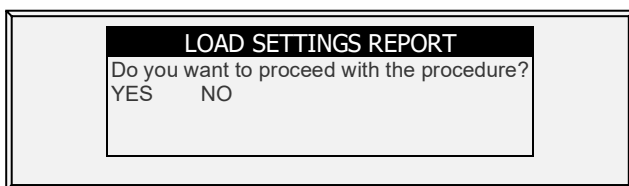

6. To proceed, select YES.
 - After loading the settings and resetting the controller, a record of incompatible tables can be viewed in Events Log History (page 81). Note that pathway is shown using a number to indicate the menu.

10.1.14 CURRENT SENSE RELAY CALIBRATION

NOTE The Current Sense relays support single phase electricity only.

This menu calibrates the amount of current that passes through Current Sense relays. Calibration enables configuring the minimum and maximum permissible currents.

To calibrate the current sense relay:

1. Define the relay.

2. Select *Service > Relay Current Cal.* The following screen appears.

RELAY CURRENT CALIBRATION			
Relay	Function	Measure	Current
			ON
31	Heat 6	Start	0.0
32	Heat 7	Start	0.0
33	Heat 8	Start	0.0
34	Exh. Fan 5	Start	0.0
35	Exh. Fan 6	Start	0.0

Warning!!!
 The selected equipment will be turned ON now for current reading adjustment WAIT till operation completion for 15 sec
 Verify that the relay switch is AUTO

3. Select a relay and click Enter.

NOTE Set the relay to Auto.

4. Repeat for each current sense relay.

RELAY CURRENT CALIBRATION			
Relay	Function	Measure	Current
			ON
31	Heat 6	Done	0.2
32	Heat 7	Done	0.2
33	Heat 8	Done	0.2
34	Exh. Fan 5	Done	3.8
35	Exh. Fan 6	Done	4.3

Warning!!!
 The selected equipment will be turned ON now for current reading adjustment WAIT till operation completion for 15 sec
 Verify that the relay switch is AUTO

5. To set the minimum and maximum voltages, alarms and 110/220 voltage, refer to Management Menu: Relay Current, page 132.

10.1.15 WIND DIRECTION CALIBRATION

Use this screen to calibrate a wind direction sensor.

➡ Define an analog sensor as wind direction.

WIND DIRECTION CALIBRATION		
	Direction	Calibration
Wind Direction	6	14.50

10.1.16 WOD CALIBRATION

➤ Define an analog sensor as WOD.

WATER ON DEMAND CALIBRATION		
	Volt	Pressure - PSI
WOD 1st Calib.	2.50	14.50
WOD 2nd Calib.	7.50	43.50

READ ME

Enter output voltage for first point.
Enter water meter measure pressure.
Repeat this for the second point.

1. In *Installation* > *Setup*, set the Length Unit.
 - Metric = Bar
 - Non-Metric = PSI
2. In *Service* > *WOD Calibration*:
 - a. Enter the first voltage and check pressure data points.
 - b. Repeat for second data points.
3. Set the Help Definitions (optional)

10.1.16.1 WOD Calibration Help | Set Definitions

This parameter reduces the water pressure by a user-defined factor.

SYSTEM PARAMETERS	
WATER ON DEMAND	
Pressure Reducer Factor	50.00

1. In *Install* > *Setup*, define the Pressure unit.
2. In *Service* > *WOD Calibration* > *Help*, define the reduction factor. Water pressure is reduced by 1/50 (bar or PSI). The factor is accurate to two decimal points.

10.1.17 AMMONIA CALIBRATION

➤ Define an analog sensor as ammonia sensor.

To calibrate the ammonia level, obtain a suitable test kit and use the procedures described in the kit. Ensure that the house is well ventilated, either naturally or using fans.

➤ Only calibrate the sensor if you have reason to believe that they are producing inaccurate results.

AMMONIA CALIBRATION	
PPM at 0VDC	0
PPM at 5VDC	100
Factor (ppm)	0

AMMONIA (ppm) 15

- Define the following:
 - Ppm at 0 VDC: Parts per million at 0 VDC

- Ppm at 5 VDC: Parts per million at 5 VDC
- Factor (ppm): (-/+) ppm shift from the current reading. Correct the sensor reading by editing this factor. The controller saves this data.
- Ammonia (ppm): Current ammonia reading
- Adjust the Controller reading as needed using the left/right arrow keys. Refer to Ammonia Treatment.

10.2 Management Menu: Relay Current

NOTE The Relay Current feature supports single phase electricity only.

This menu configures the relay current sense parameters. You can configure:

- the minimum and maximum amperage flowing to the relays
- the relay current alarm
- voltage type

NOTE Configuring the amperage is not required. The Platinum Touch / Rotem One controller automatically configures default settings.

RELAY CURRENT SETTING						
Rly.	Function	Min	Nom	Max	Alr	Vlt
31	Heat 6	2.7	3.8	5.0	NO	110
32	Heat 7	2.7	3.8	5.0	NO	110
33	Heat 8	3.0	3.8	5.6	NO	110
34	Exh. Fan 5	2.7	4.3	5.0	NO	110
35	Exh. Fan 6	2.3	3.8	5.0	NO	110
36	Tun. Fan 1	3.0	4.3	5.6	NO	110
37	Tun. Fan 2	0.0	0.0	0.0	NO	110
38	Tun. Fan 3	0.0	0.0	0.0	NO	110

NOTE Calibrate the relay before configuring these parameters. Refer to Current Sense Relay Calibration. Relays that are not calibrated (or if the relay is not a Current Sense relay) do not display amperage readings (see relays 37 and 38 in the above figure).

To configure the relay current:

1. Using the arrow buttons, select a minimum or maximum amperage setting.
2. Configure the parameter as required.

NOTE The minimum amperage must be greater than the default minimum and the maximum amperage must be less than the default maximum. For example, relay 35's amperage must be more than 2.3 and less than 5.0 amps.

The Nom amperage is the parameter set when [calibrating the relay](#).

3. Configure the alarm:

- No: Alarms are not sent in the event of low or high current
- Yes: Alarms are sent in the event of low or high current
- No at zero: The controller sends an alarm if the current is low or high, but not if power is cut off entirely.

4. Configure the voltage: Select 110 or 220 volts.

NOTE All relays' minimum/maximum current settings per equipment type must be within 30% (±) of the nominal value. However, the augers minimum can go down to 0.0 amperes.

10.3 Test Menu

- Alarm
- Analog Sensors
- Digital Sensors
- Analog Output
- Static Pressure
- Communication

10.3.1 ALARM

Press Enter to toggle the Alarm Relay.

- ON means alarms are functioning.
- OFF means alarms are not functioning.

Note that the alarm relay is powered for the 'NO ALARM' condition to provide automatic Power Fail Alarm in case of power failure to the controller. That is, the Normally Open side is closed during NO ALARM.



10.3.2 ANALOG SENSORS

Observe the converter readings for analog sensors with this menu.

The screenshot shows a terminal window with the following table:

ANALOG IN TEST			
In.	Sensor	CARD 1	
1	Temp. Sensor 1	470	64.0
2	Temp. Sensor 2	426	87.2
3	Temp. Sensor 3	470	85.6
4	Temp. Sensor 4	426	82.0
5	Temp. Sensor 5	470	87.0
6	<None>		
7	<None>		
8	<None>		
9	<None>		
10	<None>		

At the bottom of the terminal window, the following information is displayed:

```

Box 1 Card 1 Slot 3 Channel 1
  
```

The readings can vary from 0 to 1023. The values displayed in the 'Value' column indicate that the analog sensor is operating or not according to the following:

- If a very large value is shown (such as a four-digit number) or a small value is shown (such as a one-digit number): sensor is **not connected**.
- If the unit displays a 3-digit number, usually beginning with the digit '4': sensor is **operating**.

10.3.3 DIGITAL SENSORS

This screen displays the digital sensors states.

DIGITAL IN TEST			
In.	Sensor	State	Counter
CARD 1			
1	Water Meter 1	1	0
2	Water Meter 2	0	0
3	Fogger Water Meter	0	0
4	AUX. Alarm	0	0
5	AUX. Alarm	0	0
6	Low Water Pressure	0	0
7	Wind Speed	0	0
8	<None>	0	0
Box 1	Card 1	Slot 3	Channel 1

A '1' implies a shorted input, a '0' an open input. The digital sensors operate with dry contact inputs such as the Arad Water Meter, or micro-switches.

You can apply a short/open input to each channel; the response is then displayed.

NOTE The water meter quantities appear on the main screen or on Hot Screen 0.

10.3.4 ANALOG OUTPUT

This screen tests light dimmers, variable speed fans, and variable heaters.

1. Scroll to the required output.
2. Enter the test voltage and verify that the device is operating.

ANALOG OUT TEST		
Output.	Sensor	0 – 10v
CARD 1		
1	Light Dimmer 1	0.0
2	Light Dimmer 2	0.0
3	Light Dimmer 3	0.0
4	Var. Heat	0.0
5	W.O.D	0.0
6	<None>	0.0
7	<None>	0.0
8	<None>	0.0
Box 1	Card 1	Slot 3 Channel 1

10.3.5 STATIC PRESSURE

Observe the converter readings for the static pressure sensor. The nominal 'zero' pressure reading is 130. Remove the air hoses from the brass connectors on the left side outside of the controller to check this reading.

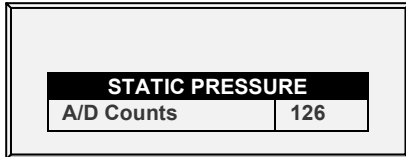

STATIC PRESSURE	
A/D Counts	126

10.3.6 COMMUNICATION

This menu facilitates testing on communication networks. A multiplexer in loop back mode is used to test communication. The Controller follows its' own communication to check for failed hardware. Follow the instructions displayed on the screen.

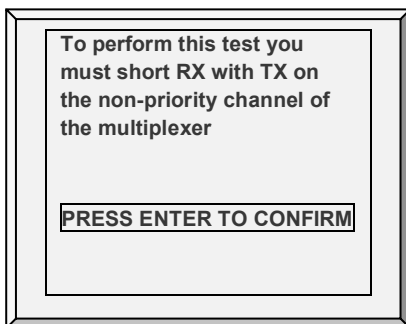

11 Appendix E: Breeder Mode

This section details functions specific to the Platinum Touch / Rotem One Breeders mode.

🔑 Control	Temperature Curve	Foggers	Egg Room Control
📁 Management	Min Vent Timer	Water & Feed	Work Room Control
🕒 History	Timer Settings	Light	Nests
🔧 System	Humidity Treatment	Extra Systems	Feed Scale Program
	CO2 Treatment	Control Mode	Light Dimmers
	Static Pressure	System Parameters	
	Cool Pad	Ammonia Treatment	

- Egg Room Setup
- Egg Counter
- Egg Room Water and Feed
- Egg Belt Runtime
- Nest Function
- Work Room Control
- Weighing the Birds in Breeder
- Breeder Advanced Feeding

NOTE To set the mode to Breeders, refer to Selecting the Mode, page 13.

11.1 Egg Room Setup

The following procedures details the steps required to set up the Egg Room functions.

1. In *System > Relay Layout*, define five relays as:
 - Egg room heater
 - Egg room fan 1
 - Egg room fan 2
 - Egg Room Cool
 - Humidifier

Relay Layout

Relay No.	Device	No.	N.C.
▾ Card 2 Main Slot 2			
11	Auger	2	<input type="checkbox"/>
12	Feeder	1	<input type="checkbox"/>
13	Water	1	<input type="checkbox"/>
14	Egg Room Heat	1	<input type="checkbox"/>
15	Egg Room Fan	1	<input type="checkbox"/>
16	Egg Room Cooling	1	<input type="checkbox"/>
17	E. R. Humidifier	1	<input type="checkbox"/>
18	Nest Open	1	<input type="checkbox"/>
19	Nest Close	1	<input type="checkbox"/>
20	W.Room Heat	1	<input type="checkbox"/>
▸ Card 3 Main Slot 3			

NOTE Refer to Relay Layout, page90, for details on this screen.

2. In System > Sensors, > Analog Sensors set the input functions as Temperature Sensors and as an Egg Room Humidity sensor

NOTE Refer to Analog Sensors, page 92 for details on this screen.

3. In System > Temperature Definition, configure which temperature sensors operate in the egg room.

Temperature Definition

Function	Sensors					
	1	2	3	4	5	6
Full House	<input checked="" type="checkbox"/>	<input checked="" type="checkbox"/>	<input checked="" type="checkbox"/>	<input checked="" type="checkbox"/>	<input checked="" type="checkbox"/>	<input checked="" type="checkbox"/>
Tunnel	<input type="checkbox"/>	<input type="checkbox"/>	<input type="checkbox"/>	<input type="checkbox"/>	<input type="checkbox"/>	<input type="checkbox"/>
Attic	<input type="checkbox"/>	<input type="checkbox"/>	<input type="checkbox"/>	<input type="checkbox"/>	<input type="checkbox"/>	<input type="checkbox"/>
Outside	<input type="checkbox"/>	<input type="checkbox"/>	<input type="checkbox"/>	<input type="checkbox"/>	<input type="checkbox"/>	<input type="checkbox"/>
Egg Room	<input checked="" type="checkbox"/>	<input type="checkbox"/>	<input checked="" type="checkbox"/>	<input type="checkbox"/>	<input checked="" type="checkbox"/>	<input type="checkbox"/>
W.Room	<input type="checkbox"/>	<input type="checkbox"/>	<input type="checkbox"/>	<input type="checkbox"/>	<input type="checkbox"/>	<input type="checkbox"/>
Stir Fan 1	<input type="checkbox"/>	<input type="checkbox"/>	<input type="checkbox"/>	<input type="checkbox"/>	<input type="checkbox"/>	<input type="checkbox"/>
Cool Pad 1	<input type="checkbox"/>	<input type="checkbox"/>	<input type="checkbox"/>	<input type="checkbox"/>	<input type="checkbox"/>	<input type="checkbox"/>
Tunnel 1	<input type="checkbox"/>	<input type="checkbox"/>	<input type="checkbox"/>	<input type="checkbox"/>	<input type="checkbox"/>	<input type="checkbox"/>

NOTE Refer to Temperature, page 95 for details on this screen.

4. Using the Keyboard: In Service > Humidity Calibration, calibrate the Egg Room humidity sensor.

HUMIDITY CALIBRATION		
Sensor	Humidity°	Factor
In-1	58.9	2.3
In-2	58.9	2.3
Out	N/A	---
Egg Room	67	2.0

Press Left/Right Arrows to Calibrate

5. In *Control > Egg Room*, set the following on/off parameters:

- Heater temperature
- Fan 1 temperature
- Fan 2 temperature
- Cooling temperature
- Humidifier relative humidity percentage

Egg Room Control				
Heater (Temp) On	16.7 	Heater (Temp) Off	18.9 	
Fan 1 (Temp) On	21.1 	Fan 1 (Temp) Off	18.9 	
Fan 2 (Temp) On	21.1 	Fan 2 (Temp) Off	18.9 	
Cooling (Temp) On	0.0 	Cooling (Temp) Off	0.0 	
Humidifier (%rh) On	65 	Humidifier (%rh) Off	70 	

6. In *Control > Egg Room Control > Help > Set*, configure the following alarm parameters:

- Low Temperature
- High Temperature
- Low Humidity
- High Humidity
- Delay (minutes)

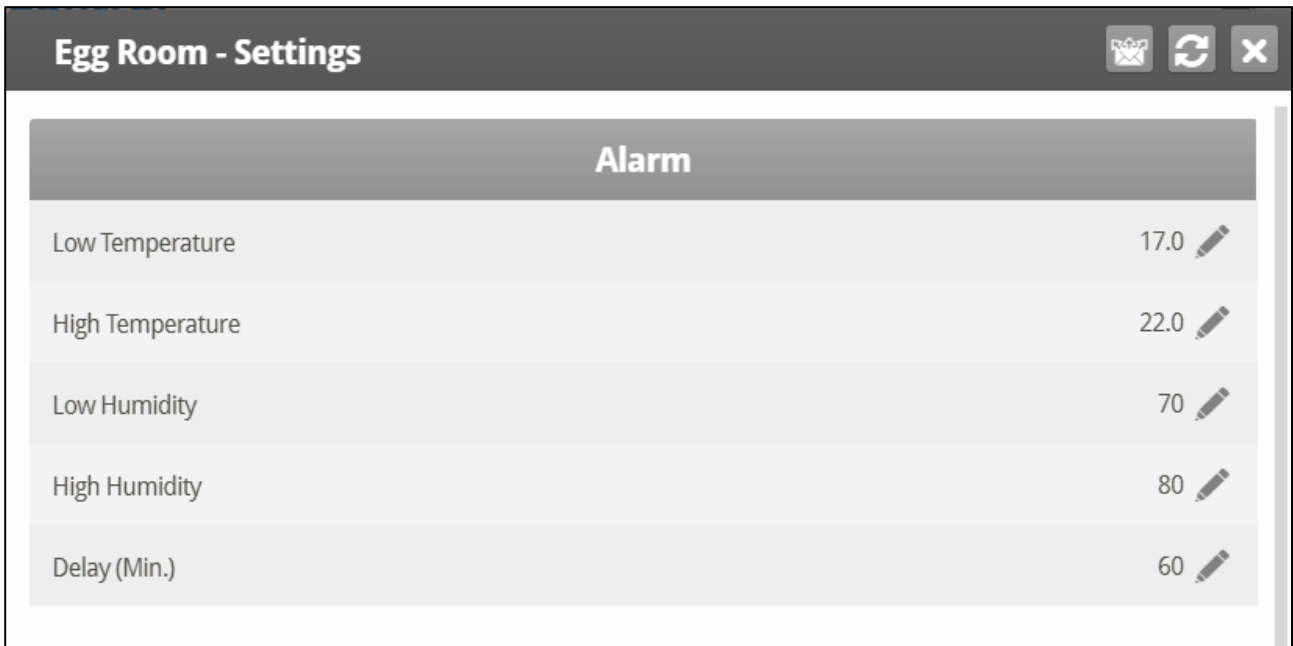

The Breeder Mode is configured.

11.2 Egg Counter

Platinum Touch / Rotem One Breeders Mode supports up to four egg counters per house. Platinum Touch supports Accucount infra-red egg counters (refer to the Egg Counter manual for details). The following sections detail the setup.

1. In *System > Digital Sensors*, define up to four sensors as Egg Counter.

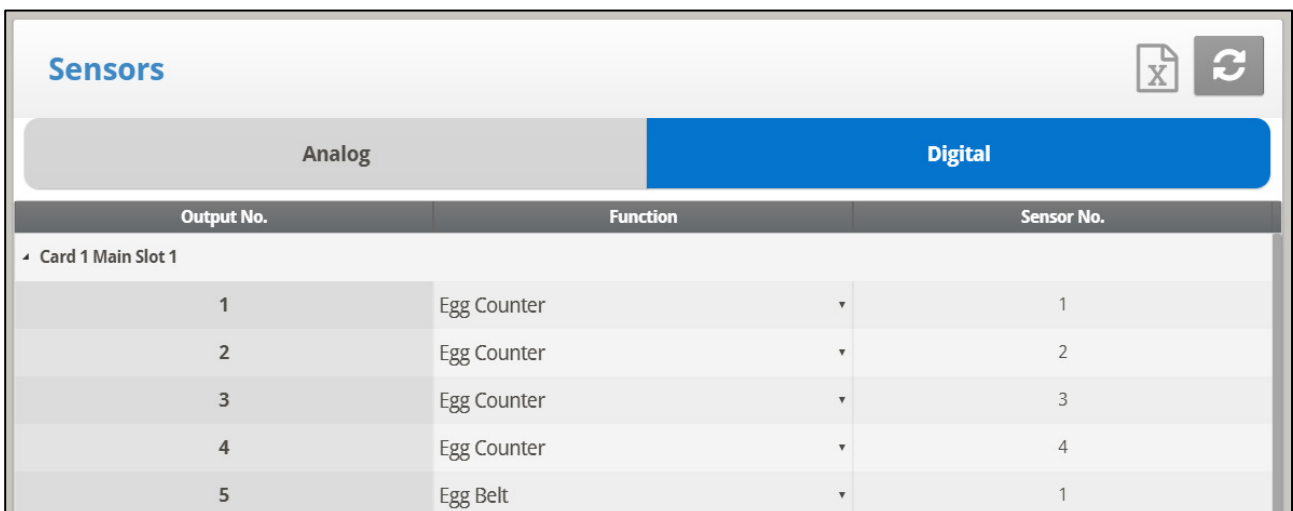

2. Set the Alarms (refer to Alarm Setting Help | Set Definitions, page 58 for details on how to set alarms).

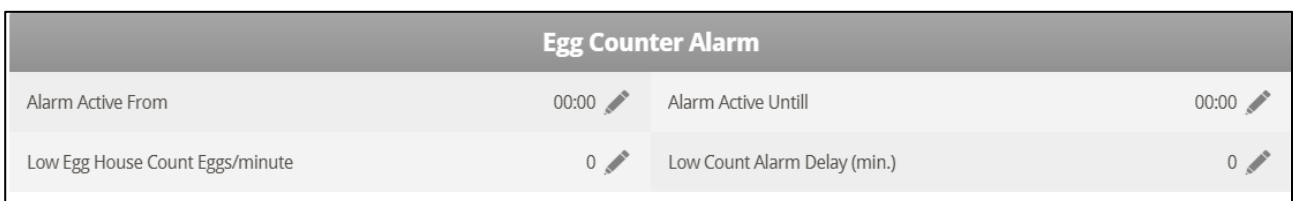

- **Alarm Active From/Untill:** Set the period for which the controller generates alarms.

- **Low Egg House Count Eggs/Minute:** Define the number of eggs per minute at which an alarm is generated.
- **Low Count Alarm Delay (min):** Set the minimum period of time low egg count must extend through before generating an alarm

3. The Main Screen displays the current day's total egg count.

Tunnel	25.6 C°	Egg Room	25.6 C°
W.Room	---	Feed Area	---
Attic	---	🏠 Temp 1	25.6 C°
Temp 2	---	🏠 Temp 3	25.6 C°
Temp 4	---	🏠 Temp 5	25.6 C°
Temp 6	---	Eggs 1	2590
Eggs 2	2145	Eggs 3	1489
Eggs 4	1768		

4. To test the egg counter sensor(s), on the Keyboard, go to *Test > Digital Sensors*.

DIGITAL IN TEST			
In.	Sensor	State	Counter
1	Egg Counter 1	1	0
2	Egg Counter 2	0	0
3	Egg Counter 3	0	0
4	Egg Counter 4	0	0
5	<None>	0	0
6	<None>	0	0
7	<None>	0	0
8	<None>	0	0

5. In *History > Egg Counters*, view the total egg count.

Eggs History				
Day	1	2	3	4
1	2590	2145	1489	1768

11.3 Egg Room Water and Feed

In Breeder Mode, the water and feed schedule is independent of the growth day. In addition, Breeder Mode enables lowering the target temperature during the feeding time. When birds begin to feed, they congregate near the feeders and the temperature rises (which negatively affects the birds' feed intake). To compensate, increase the ventilation before/during the feeding time by lowering the target

11.3.1 SETUP

1. Go to *Control > Water & Feed*.

Water & Feed Control			
From Time	To Time	Water	Feeder
		1	1
05:00	07:00	●	●
09:00	10:00	●	●
00:00	00:00	X	X
00:00	00:00	X	X
00:00	00:00	X	X

2. Set the parameters as required:

- Time: Set event times for water, feeder, or auger.
- Set the water, feeder, and auger lines to Continuous, Cycle, or Off.

3. In *System > Setup*, define *Feed Area* as *Yes*.

NOTE If you do not define *Feed Area* as *Yes*, *Feed Area* does not appear in *Temperature Definition*.

4. In *System > Temperature Definition*, map a temperature sensor(s) to the feed area (optional).

5. Go to *Control > Water & Feed > Help* (optional).

Water & Feed - Settings

Temp Target Adjust

Change Target From	00:00	Change Target To	00:00
Target Offset	0.0		

Feed Line Operation

Line 1 Down	00:00	Line 1 Up	00:00
Line 2 Down	00:00	Line 2 Up	00:00

6. If a device is set to *Cycle*, define the *Water/Feeder/Auger On* and *Off* times.

7. To adjust the target temperature during feeding (to increase ventilation):

- a. Define the *To/From* times.
- b. Define the *Target Temperature Offset* (to reduce the target).

NOTE To disable this feature set the offset to 0.

8. To control the male breeders feeding time:

- a. Under Feed Line Operation, define when the lines descend and rise (Line Down, Line Up times).
- b. On the keyboard: Go to *Service > Feed Line Calibration*.
- c. Enter the amount of time required for the curtains to rise and descend.

NOTE Measure these times if you don't know them.



FEED LINE CALIBRATION	
Function	Run Time (sec.)
Feed Line 1 Up	60
Feed Line 1 Down	50
Feed Line 2 Up	80
Feed Line 2 Down	40





Additional points:



- In Breeder Mode, Platinum Touch / Rotem One supports up to:
 - 10 feeders
 - Four water lines
 - Four augers
- Define these functions in System > Relays.
- To and From times can overlap. For example, in the table above one line goes from 4:45 to 5:15 and the next line goes from 5:00 to 5:30. If there is overlap and contradictory configurations, the priority is Continuous > Cycle > Off. In the example above:
 - Water Line 2 will run in a cycle from 5:00 until 5:30.
 - Feeder Line 1 will be on from 4:45 until 5:15, even though line 3 turns off the feeder.





11.3.2 WATER AND FEED VERSION 7.24 AND ABOVE



When running Platinum Touch in Breeder Basic Mode, Version 7.24 and above Water, Feeder, and Auger Tables appear in separate windows; each window can be configured independently. The functionality and configuration is the same as in Version 7.23.



Feed   

From Time	To Time	Feeder	
		1	2
05:00	05:30		X
07:00	08:00		X
09:00	09:30		
00:00	00:00	X	X

Auger   

From Time	To Time	Auger	
		1	2
05:00	05:30		X
06:00	07:00		X
08:00	09:00		
00:00	00:00	X	X

Water   



From Time	To Time	Water	
		1	2
04:00	04:30		X
05:30	06:30		X
08:00	09:00		X
00:00	00:00	X	X

11.4 Egg Belt Runtime

Platinum Touch / Rotem One Breeder supports measuring the egg belt runtime.

➡ Install digital input cards.

1. Go to *System > Digital Sensors*.

Sensors  

Analog
Digital

Output No.	Function	Sensor No.
↳ Card 1 Main Slot 1		
1	Egg Counter ▼	1
2	Egg Counter ▼	2
3	Egg Counter ▼	3
4	Egg Counter ▼	4
5	Egg Belt ▼	1

2. Define at least one sensor as Egg Belt.

3. Go to *History > Egg Belt Run Time* to view the data.

11.5 Nest Function

The Nest function enables opening and closing (up to) four Nest lines at specific times. Birds can then leave their Nests and return.

- Nest Function, Version 7.18 and Below
- Nest Function, Version 7.19

11.5.1 NEST FUNCTION, VERSION 7.18 AND BELOW

1. In *System > Relay Layout* designate up to four relays (each) as Nest Open and Nest Close valves.

Relay Layout				
Relay No.	Device	No.	N.C.	
▾ Card 4 Main Slot 4				
31	Nest Open	2	<input type="checkbox"/>	
32	Nest Close	2	<input type="checkbox"/>	
33	Nest Open	3	<input type="checkbox"/>	
34	Nest Close	3	<input type="checkbox"/>	
35	Nest Open	4	<input type="checkbox"/>	
36	Nest Close	4	<input type="checkbox"/>	
37	None	0	<input type="checkbox"/>	
38	None	0	<input type="checkbox"/>	
39	None	0	<input type="checkbox"/>	
40	None	0	<input type="checkbox"/>	
▸ Card 5 Main Slot 5				

2. In *Control > Nest*, define the parameters:

Nests				
Number	Open		Close	
	Time	Duration (sec)	Time	Duration (sec)
1	07:00	300	09:00	300
2	10:00	300	12:00	300
3	13:00	300	15:00	0
4	16:00	300	18:00	300

- **Open Time:** The time each Nest lines' doors open.
- **Duration:** The amount of time required for the Nests to open.
- **Close Time:** The time each Nest lines' doors close.
- **Duration:** The amount of time required for the Nests to close.

11.5.2 NEST FUNCTION, VERSION 7.19

In Version X.19, the nest function operates in two different manners, depending on the number of relays required to open and close the nests.

- Single Relay
- Dual Relay

11.5.2.1 Single Relay

When using a single relay:

- applying electricity opens the cages
- ceasing the electricity closes the cages.

The user defines when the relay opens (allows current) and when the relay closes (ceases current), thereby opening or closing the cage.

1. In *Installation > Relay Layout* designate up to four relays as Nest Open relays. The number of defined relays is what appears in the screen.

NOTE *In this setup there is no need to designate relays as Nest Close.*

2. In *Control > Nests > Set Definitions*, define the Nest Mode as Single (default is Dual).

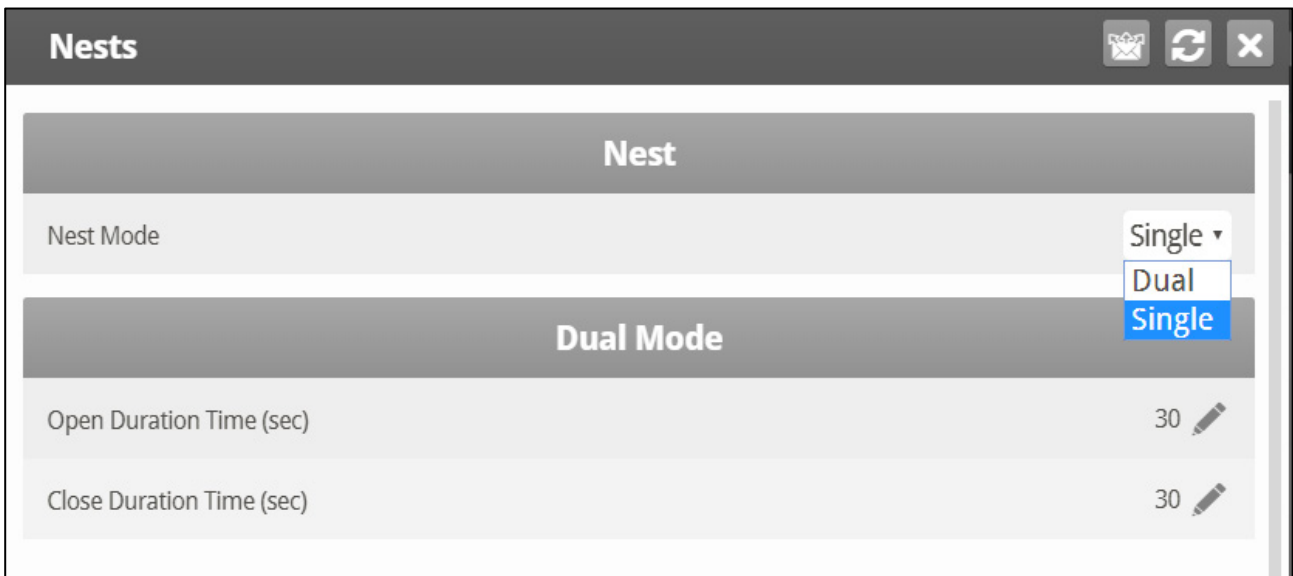

3. In *Control > Nest*, define the:

- *Time: This schedules when the relay enables or disables current to flow (daily).*
- *Nest: Under each nest, define if it opens or closes.*

In the example below, Nests 3 and 4 open at 12:00 and close at 15:00. Nests 1 and 2 open at 15:00 and remain open until 12:00 the following day.

Nests		Nests			
Number	Time	1	2	3	4
1	12:00	Off	Off	On	On
2	15:00	On	On	Off	Off
3	00:00	Off	Off	Off	Off

11.5.2.2 Dual Relay

When using dual relays, one relay opens the cage and the second closes the cage. A specific command must be given for each function. Cages remain open or closed until a command is given to change the status.

1. In *System > Relay Layout* designate up to four relays (each) as Nest Open and Nest Close relays. The number of defined relays is what appears in the screen.
2. In *Control > Nest > Set Definitions*, define the Nest Mode as Dual (default is Dual).

Nest	
Nest Mode	Dual
Dual Mode	
Open Duration Time (sec)	30
Close Duration Time (sec)	30

3. Define the time required to open or close the cage.
4. In *Device > Nest*, define the:
 - *Time*: This schedules a relay is activated.
 - *Nest*: Under each nest, define which relay operates on a nest.
 - O: Nest opens
 - C: Nest closes
 - None: No action (relay is closed or released)

In the example below, Nests 3 and 4 open at 12:00. Nest 2 opens at 15:00. Nest 3 closes at 16:00, while Nests 2 and 4 remain open.

Nests		Nests			
Number	Time	1	2	3	4
1	12:00	None	None	O	O
2	15:00	None	O	None	None
3	16:00	None	None	C	None
4	00:00	None	None	None	None

11.6 Work Room Control

This screen enables controlling the temperature in the work room.

Work Room Control		
Function	On	Off
Heater 1 (Temp)	16.7	18.9
Heater 2 (Temp)	16.7	18.9
Fan 1 (Temp)	21.1	18.9
Fan 2 (Temp)	21.1	18.9

1. In *Control > Work Room*, set the following on/off parameters:

- Heater 1 and 2 temperatures
- Fan 1 temperature
- Fan 2 temperature

2. In *System > Temperature Definition*, define 1 or 2 sensors as Work Room temperature sensors (refer to Temperature Definition, page 95 for details on this function)

Temperature Definition						
Function	Sensors					
	1	2	3	4	5	6
Full House	<input checked="" type="checkbox"/>	<input checked="" type="checkbox"/>	<input checked="" type="checkbox"/>	<input checked="" type="checkbox"/>	<input checked="" type="checkbox"/>	<input checked="" type="checkbox"/>
Tunnel	<input type="checkbox"/>	<input type="checkbox"/>	<input type="checkbox"/>	<input type="checkbox"/>	<input type="checkbox"/>	<input type="checkbox"/>
Attic	<input type="checkbox"/>	<input type="checkbox"/>	<input type="checkbox"/>	<input type="checkbox"/>	<input type="checkbox"/>	<input type="checkbox"/>
Outside	<input type="checkbox"/>	<input type="checkbox"/>	<input type="checkbox"/>	<input type="checkbox"/>	<input type="checkbox"/>	<input type="checkbox"/>
Egg Room	<input checked="" type="checkbox"/>	<input type="checkbox"/>	<input checked="" type="checkbox"/>	<input type="checkbox"/>	<input checked="" type="checkbox"/>	<input type="checkbox"/>
W.Room	<input type="checkbox"/>	<input checked="" type="checkbox"/>	<input type="checkbox"/>	<input checked="" type="checkbox"/>	<input type="checkbox"/>	<input type="checkbox"/>
Stir Fan 1	<input type="checkbox"/>	<input type="checkbox"/>	<input type="checkbox"/>	<input type="checkbox"/>	<input type="checkbox"/>	<input type="checkbox"/>
Cool Pad 1	<input type="checkbox"/>	<input type="checkbox"/>	<input type="checkbox"/>	<input type="checkbox"/>	<input type="checkbox"/>	<input type="checkbox"/>
Tunnel 1	<input type="checkbox"/>	<input type="checkbox"/>	<input type="checkbox"/>	<input type="checkbox"/>	<input type="checkbox"/>	<input type="checkbox"/>

11.7 Scale Arm

During feed distribution, each silo has a mechanical arm that disconnects at the end of a feed cycle, preventing further distribution. When this disconnect happens, a signal is sent from the arm to the silo, informing the latter that it must be refilled. Platinum Touch / Rotem One enables recording these signals in the Events History.

To define the Scale Arm:

1. Go to *System > Digital Sensors*.
2. Define one sensor as Scale Arm.

Sensors		
Analog		Digital
Output No.	Function	Sensor No.
Card 1 Main Slot 1		
1	Egg Counter	1
2	Egg Counter	2
3	Egg Counter	3
4	Egg Counter	4
5	Egg Belt	1
6	Scale Arm	1
7	Intermediate	1
8	Hopper	1
9	Heat Exchanger	1

- In *History > Table of Events*, Feed Delivered appears when the mechanical arm disconnects.

Day	Time	Message
1	15:15:30	Cold Start
1	15:15:30	Min Ventilation
1	15:15:30	Feed Delivered

11.8 Weighing the Birds in Breeder

The following section details how to set up scales to weigh the birds.

- **Scale Layout:** Use the process detailed in the Broiler Section. Refer to **Scale Layout, page 102**.
 - Bird Scale Setting
 - Bird Weight History

11.8.1 BIRD SCALE SETTING

There are two options for setting up the curve used as a reference weight for the bird weights, using a controller-generated curve and using an industrial standard curve.

- Measuring Bird Weights, Auto Curve
- Measuring Bird Weights, Customized/Industrial Standard Curve

11.8.1.1 Measuring Bird Weights, Auto Curve

1. Go to System > Scale > Bird Scale Setting.

Scale Settings	
Bird Scale	Silo
Weight Method	Auto
Scale 1	Female Weight
Scale 2	Female Weight
Scale 3	Male Weight
Scale 4	Male Weight

2. In Weighing Method, select **Auto**.
3. Go to System > Scale > Bird Scale Setting > Help. Define the parameters (option).

Scale Setting

FEMALE

Upper Range 10 

Lower Range 15 

MALE

Upper Range 15 

Lower Range 10 

- Male/Female: The upper/lower range parameters defines the range of weights that are recorded. The weights of birds that exceed differ from the bird curve by these amounts are discarded. Note that the default range of the female and male bird are reversed.

4. Go to System > Bird Weight.

Bird Weight

Description	Value
Current Female Weight	0.042
Current Male Weight	0.042

5. The Bird Weight screen displays the target weight for the current growth day for each gender. Edit the weight as required.

11.8.1.2 Measuring Bird Weights, Customized/Industrial Standard Curve

1. Go to System > Scale > Bird Scale Setting.

Scale Settings

Bird Scale | Silo

Weight Method Curve 

Scale 1 Female Weight 

Scale 2 Female Weight 

Scale 3 Male Weight 

Scale 4 Male Weight 

2. In Weighing Method, select Curve.

3. Go to Scale > Bird Scale Setting > Help. Define the parameters (option).

- Male/Female: The upper/lower range parameters defines the range of weights that are recorded. The weights of birds that exceed differ from the bird curve by these amounts are discarded. Note that the default range of the female and male bird are reversed.

4. Go to System > Bird Weight > Help.

5. Define the parameters:

- Curve Offset: Enter the factor used to adjust the weight curve. This amount is added to the curve. Range: -4.40 to +4.41 Kg/Lb.
- Select Curve:
 - Custom: the Bird Weight screen displays a generic curve for each day's target weight. You can edit the weight as required.
 - Factory default curve: The Bird Weight screen displays each day's target weight using an industry standard. These data points are read-only. Note that there are different curves for female or male birds.

6. Go to System > Bird Weight.

Day	Female	Male
0	0.042	0.042
7	0.160	0.150
14	0.285	0.340
21	0.410	0.525
28	0.540	0.690
35	0.645	0.830
42	0.750	0.960
49	0.850	1.090
56	0.950	1.220
63	1.050	1.345
70	1.160	1.470
77	1.250	1.595

- The Bird Weight screen displays the target weight for the current growth day for each gender.
 - If you selected Custom in Help, edit the fields as required.
 - If you selected an industrial standard, all fields are read-only.
- Note: If you select Custom, the controller saves all changes that you make to the fields. Meaning that after configuring a customized curve, you can go to the Help, select an industrial curve, and then go back and select Custom. The curve that you defined will reappear.

11.8.2 BIRD WEIGHT HISTORY

The scale history shows bird weight statistics for female and male houses. You can review daily data for each gender or for each scale.

Day	Female Weight			Male Weight			Scale 1			
	Average	Uniformity	No.	Average	Uniformity	No.	Average	Uniformity	No.	Average
1	0.000	0	0	0.000	0	0	0.000	0	0	0.000

11.9 Breeder Advanced Feeding

Breeder Mode supports a unique feed mixing and distribution system that includes:

- Mixing feed from up to eight silos
- Distributing the feed to up to eight different feed lines
- Differentiating between male, female, or mixed sex lines
- Support for up to 24 feeding stations (16 female and 8 males)

In this system (up to eight) silos place their feed onto auger lines, which transport the feed to a feed scale container. The feed is mixed in the feed scale container and then placed into hoppers, from which the feed is transported to the birds. What is unique in this program is the flexibility in designing feeding lines for male, female, and mixed lines. Using the Platinum Touch / Rotem One program, you define the entire feeding program:

- mapping silos to augers
- how much feed from each silo,
- what type of feeding program to use
- which feeding stations are active

How does it work?

- Silos deliver feed to the feed scale container; the user defines how much feed each silo delivers (in percentages of the total weight).
- After delivering the feed, the silo augers are turned off and feed is placed in the hopper from which the feed is then placed into feed lines.
- Each hopper delivers feed to one or two lines:
 - If one feed line is used it can supply to feed to males, females, or both.
 - If two feed lines are used, one line is designated for the males and one line is designated for females
- When the hopper empties, the process repeats itself until the supplied feed equals the defined target.
- Continuous feeding: You In standard feeding, the feed line hoppers are filled serially. A line hopper valve does not open until the previous valve closes. In the advanced feeding mode, you can configure the setup to ensure that the delays between the feed line hopper fillings overlap.

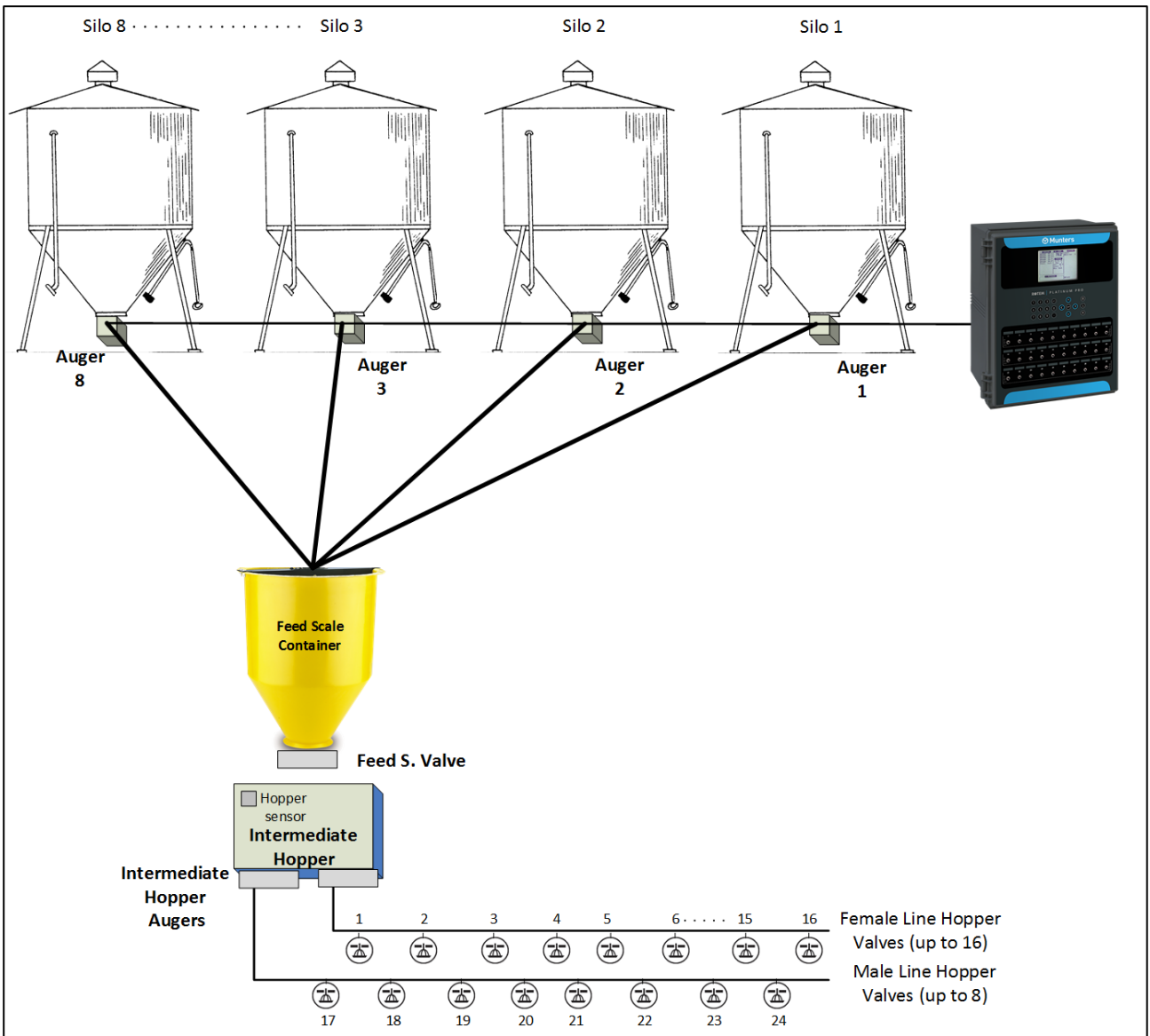

Figure 8: Dual Line Block diagram

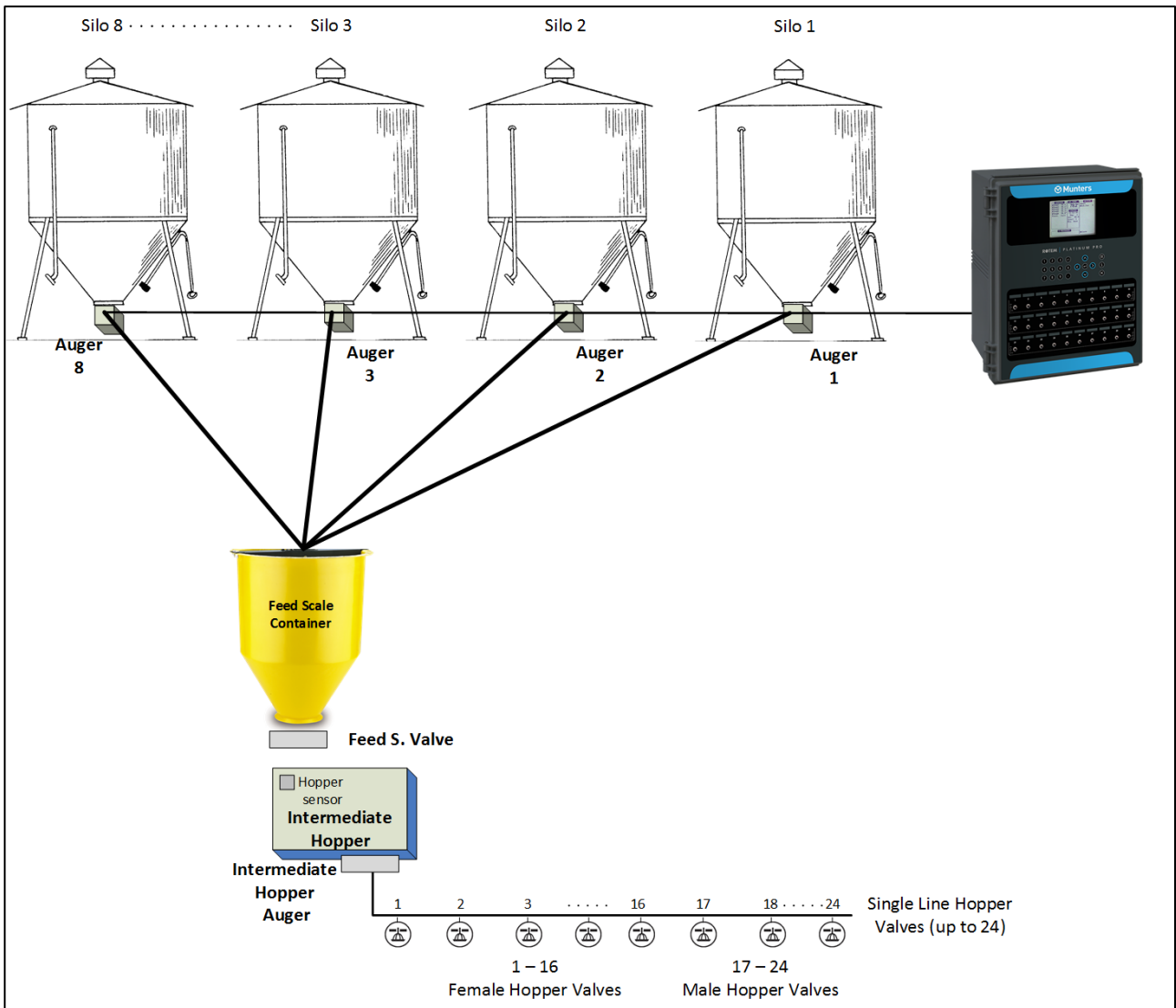

Figure 9: Single Line Block diagram

11.9.1 SELECTING THE MODE



To enable the Breeder advanced feeding mode:

1. Disconnect the power cable from the power source.
2. Reapply power while pressing Delete. The Cold Start screen appears.
3. Select Yes. The Choose Controller Type appears.
4. Select the Breeder.
5. Select Precision.
6. Select Advanced Feeding.
7. Press Enter.

11.9.2 SETUP

Warning: Do not configure these screens while a feeding cycle is in progress.

1. Go to System > Relays.

Relay Layout					
Relay No.	Device	No.	N.C.		
▶ Card 4 Main Slot 4					
◀ Card 5 Main Slot 5					
41	Auger ▼	3		<input type="checkbox"/>	
42	Auger ▼	4		<input type="checkbox"/>	
43	Auger ▼	5		<input type="checkbox"/>	
44	Auger ▼	6		<input type="checkbox"/>	
45	Auger ▼	7		<input type="checkbox"/>	
46	Line Hopper Valve ▼	3		<input type="checkbox"/>	
47	Line Hopper Valve ▼	2		<input type="checkbox"/>	
48	Line Hopper Valve ▼	4		<input type="checkbox"/>	
49	Line Hopper Valve ▼	5		<input type="checkbox"/>	
50	None ▼	0		<input type="checkbox"/>	

2. Define:

- Up to eight relays as augers.
 - As an option, you can manually number the augers.
- One Feed Scale Valve (Version 7.22)
- Up to **two** intermediate hopper augers.
- Up to 24-line hopper valves.
 - Platinum Touch/Rotem One defines line hopper valves 1 – 16 as being female line hopper valves and valves 17 – 24 as being male line hopper valves.
 - If you are not using all 16 female valves or all 8 male valves, you can manually number the valves. For example, four valves can be numbered as 1 – 4 and the fifth valve numbered as 17.
 - Number the female and male valves sequentially. For example:
 - 1 – 4 or 5 – 7 and 17 – 20 or 21 – 24 are fine.
 - 1, 4, 7, 9 and 17, 21, 24 is incorrect.

3. Go to *Control > Water & Feed*.

Water & Feed Control							
From Time	To Time	Water			Feeder		
		1	2	3	1	2	3
06:00	06:45	●	X	X	●	X	X
08:00	09:00	●	X	X	●	X	X
10:00	10:30	●	○	X	●	○	X
00:00	00:00	X	X	X	X	X	X
00:00	00:00	X	X	X	X	X	X
00:00	00:00	X	X	X	X	X	X
00:00	00:00	X	X	X	X	X	X
00:00	00:00	X	X	X	X	X	X
00:00	00:00	X	X	X	X	X	X
00:00	00:00	X	X	X	X	X	X
00:00	00:00	X	X	X	X	X	X

4. Set the parameters as required:

- Time: Set event times for water or feeder.
- Set the water or feeder lines to Continuous, Cycle, or Off.

5. Go to Control > Water & Feed > Help.

Water & Feed - Settings

Temp Target Adjust

Change Target From 05:55 Change Target To 08:00

Target Offset -5.0

Feed Line Operation

Line 1 Down 04:45 Line 1 Up 05:00

Line 2 Down 04:45 Line 2 Up 05:00

Water Cycle Time

Cycle On (Min.) 30 Cycle Off (Min.) 270

Feeder Cycle Time

Cycle On (Min.) 60 Cycle Off (Min.) 200

Feed Day Cycle

Feed Day Cycle Daily

6. If a device is set to Cycle, define the Water/Feeder On and Off times.

7. To adjust the target temperature during feeding (to increase ventilation):

- Define the To/From times.
- Define the Target Temperature Offset (to reduce the target).

NOTE To disable this feature set the offset to 0.

- Feed Cycle: Set to:
 - Daily: Same schedule for every day of the week.
 - 2 – 6 Days: Select a cycle that lasts the number of days chosen and then repeats itself. For example, 2 Days means that the cycle lasts two days and then repeats itself.
 - Week: Set a cycle for specific days.

NOTE When the cycle is set to 2-6 days or Week, you can skip specific days by pressing the +/- key.

8. Go to System > Silo/Auger Layout.

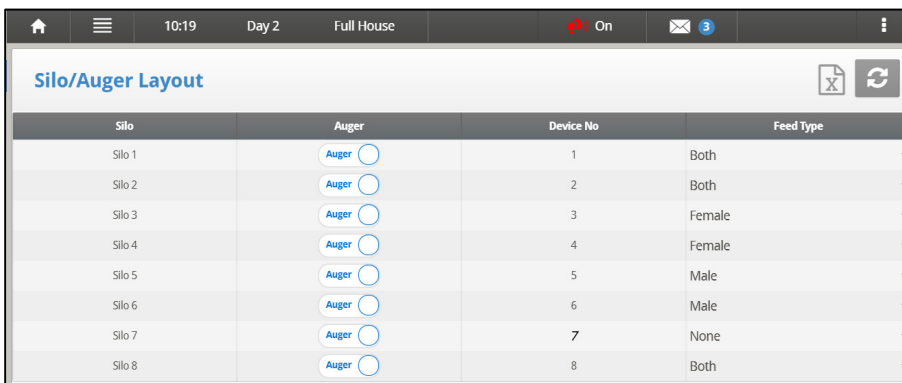

Silo	Auger	Device No	Feed Type
Silo 1	Auger <input type="radio"/>	1	Both
Silo 2	Auger <input type="radio"/>	2	Both
Silo 3	Auger <input type="radio"/>	3	Female
Silo 4	Auger <input type="radio"/>	4	Female
Silo 5	Auger <input type="radio"/>	5	Male
Silo 6	Auger <input type="radio"/>	6	Male
Silo 7	Auger <input type="radio"/>	7	None
Silo 8	Auger <input type="radio"/>	8	Both

9. Map each silo to the auger number.

- To use this function, augers must be defined in Installation > Relay Layout. No mapping is possible unless augers have been defined.
- By default, the screen displays four silos and augers. If you define more than four relays as augers (or if you number even one auger relay as number 5 or higher), the screen displays eight silos.
- Even if all eight silos appear on the screen, the number of silos you can map equals the number of auger relays defined.
- Define the parameters:
 - Silo: Read only number.
 - Auger: This defines which auger is mapped to which silo. Define this as None (disabling the auger line) or Auger. Platinum Touch/Rotem One numbers the auger but you can manually edit the number. To edit, press the required number and then Enter.
 - Feed Type: If the silo contains feed designated for males or females, define that feed type in this parameter. Alternatively, define the feed type as Both (default) or None.

10. In Management > Feed Inventory, enter the quantity of feed in each silo. Note that if the silos are equipped with load cells, this table is filled automatically.

Date	Silo							
	1	2	3	4	5	6	7	8
23-Sep-18	8,000	9,000	9,000	10,000	9,000	15,000	8,000	10,000
23-Oct-18	0	0	0	0	0	0	0	0
--	0	0	0	0	0	0	0	0
--	0	0	0	0	0	0	0	0
--	0	0	0	0	0	0	0	0
--	0	0	0	0	0	0	0	0
--	0	0	0	0	0	0	0	0
--	0	0	0	0	0	0	0	0
Total Feed	8,000	9,000	9,000	10,000	9,000	15,000	8,000	10
Active	<input checked="" type="checkbox"/>	<input type="checkbox"/>	<input type="checkbox"/>	<input type="checkbox"/>	<input type="checkbox"/>	<input type="checkbox"/>	<input type="checkbox"/>	<input type="checkbox"/>

11. Go to Control > Feed Scale Program.

Note: This screen is wide and requires scrolling to view all parameters.

No	Start Time	Type	Silo Augers (in %)								Inter. Hopp	
			1 F M	2 F M	3 F	4 F	5 M	6 M	7 N	8 N		
1	05:00	None	0	0	0	0	0	0	0	0	0	---
2	10:00	Female	0	50	0	50	0	0	0	0	0	1
3	07:00	Male	75	25	0	0	0	0	0	0	0	2
4	12:00	Both	34	33	33	0	0	0	0	0	0	1&2
5	00:00	None	0	0	0	0	0	0	0	0	0	---
6	00:00	None	0	0	0	0	0	0	0	0	0	---
7	00:00	None	0	0	0	0	0	0	0	0	0	---
8	00:00	None	0	0	0	0	0	0	0	0	0	---
9	00:00	None	0	0	0	0	0	0	0	0	0	---
10	00:00	None	0	0	0	0	0	0	0	0	0	---
11	00:00	None	0	0	0	0	0	0	0	0	0	---

Note: This screen's appearance depends on the relay layout and silo/auger layout.

- Version 7.23: All silos appear in the Feed Scale Program screen.
- Version 7.24: Only those silos actually mapped to an auger in Silo > Silo Auger Layout appear in the Feed Scale Program screen.

12. Define the feed mixture and distribution parameters.

- Number: You can define up to 20 feeding times per day.
- Type: Designate this feeding time as one of the following:
 - Female or Male. When defined as Female or Male, only those augers whose feed type matches this definition will add feed to the mixture. For example, if Number 1 is defined as Male, any auger defined as Female will not add feed at this time. However, an auger defined as Both will add feed. (Augers are defined in Scale > Silo/Auger Layout > Feed Type)

- Both: When defined as Both, any auger that is defined Male, Female, or Both can add feed to the mixture.
- None: You cannot edit that line's parameters.
- Erase: This option erases any parameter definitions for that number.
- Silo Augers (%): Under each auger, enter the percentage of feed that each silo provides. The default auger automatically adjusts its percentage as you define each auger's percentage.
 - In a line designated as Male or Female, you can only change the percentages of those augers matching the definition (or an auger defined as Both).
 - For example: If the line is defined as male, only augers defined as Male or Both can add feed. The cursor will automatically skip over any auger not matching the line definition.
 - Augers defined as None do not add feed.
- Inter. Hopper Auger: This parameter is read-only. If one auger is defined is defined, 1 appears. If two augers are defined, either one or two can appear.
 - If there is one auger line, this line can feed males, females, or both (up to 24 valves).
 - Valves 1 – 16 are female,
 - Valves 17 – 24 are male (see Figure 1)
 - If there are two auger lines:
 - The Intermediate Hopper Auger 1 relay MUST be mapped to the line feeding the females.
 - The Intermediate Hopper Auger 2 relay MUST be mapped to the line feeding the males.
- Line Hopper Valves: Define the amount of feed that each feeding station receives.
 - Version 7.21: Range 0 – 22025 Lbs/0 -9999 Kg
 - Version 7.22: Range 0 – 22025.8 Lbs/0 -9999.9 Kg

11.9.3 FEED SCALE PROGRAM HELP | SET DEFINITIONS

Feed Scale Setting	
System Parameters	
Max Portion Weight	55
Max Auger Time (Min)	10
Not Empty Time (Min)	60
Stop Diff Weight	2.2
Optimizer	Default
Valve Close Time (Sec.)	7
Feed Tare [A/D count]	0
1ST Line of Hoppers	
Auger Feed Rate [weight/min]	44
Time To First Line Hopper [sec]	120
Time To Last Line Hopper [sec]	240

- Define:

ADVANCED FEEDING SETTINGS

- **Maximum Portion Weight:** Enter the feed scale container size.
- **Maximum Auger Time [minutes]:** This parameter sets an alarm for the auger running time. Enter the number of minutes that the auger can run, after which an alarm appears on the Main Screen.
- **Not Empty Time:** This parameter (in minutes) sets an alarm for the feed scale container. The container should distribute all its feed to the feed lines. If feed remains in the container, it could mean that there is a problem (for example, the valve doesn't open). Set the amount of time that feed can remain in the container, after which an alarm appears on the Main Screen.
- **Stop Band Weight:** This parameter (kilos or pounds) defines the band at which augers cease to distribute feed. When the amount of feed distributed approaches the maximum portion weight by this amount, the controller ceases the distribution.
- **Optimizer:** This parameter sets the unit's sensitivity to signal noise (caused by a variety of factors). The sensitivity plays a role as the controller stabilizes itself. Greater amounts of noise require faster optimization. To view an indication of the controller's stability, go to *Scale Menu > Test* and perform a test. If the number remains stable, slower optimization is indicated. There are three settings: Default, Slower, Faster.

NOTE Munters recommends leaving this parameter at the default level.

- **Valve Close Time [seconds]:** Set the delay in time, if any, that the valve emptying the feed scale container closes.

- **Feed Tare [A/D count]:** This specification is used for certain tests performed by a certified technician.

NOTE *Munters recommends leaving this parameter unedited.*

Female/Male Line of Hoppers

- **Auger Feed Rate (weight/min):** Define the amount of feed to be sent to the birds over a defined amount of time.

NOTE *If you define one relay only as the Inter. Hopper Auger, enter the same rate in both the Female and Male Line of Hoppers.*

- **Time to 1st Hopper:** Amount of time required for feed to travel from the intermediate hopper to the first hopper valve.
- **Time to Last Hopper:** Amount of time required for feed to travel from the intermediate hopper to the last hopper valve. Note that the last valve is the last valve actually defined. For example if six valves are defined, enter the amount of time required for the feed to reach valve number six.
- **Line Hopper Feed Gap:** The amount of time required for feed to travel the distance between each hopper.

11.10 Egg Room History

- Go to *History > Egg Room* to view a daily history of the egg room temperature and humidity. Press the right/left arrow keys to switch between views.

Egg Room 📄 ↻						
Day	Temperature			Humidity		
	Min	Avg	Max	Min	Avg	Max
1	25.4	28.2	28.4	---	---	---

12 Warranty

Warranty and technical assistance

Munters products are designed and built to provide reliable and satisfactory performance but cannot be guaranteed free of faults; although they are reliable products they can develop unforeseeable defects and the user must take this into account and arrange adequate emergency or alarm systems if failure to operate could cause damage to the articles for which the Munters plant was required: if this is not done, the user is fully responsible for the damage which they could suffer.

Munters extends this limited warranty to the first purchaser and guarantees its products to be free from defects originating in manufacture or materials for one year from the date of delivery, provided that suitable transport, storage, installation and maintenance terms are complied with. The warranty does not apply if the products have been repaired without express authorisation from Munters, or repaired in such a way that, in Munters' judgement, their performance and reliability have been impaired, or incorrectly installed, or subjected to improper use. The user accepts total responsibility for incorrect use of the products.

The warranty on products from outside suppliers fitted to Platinum Touch, (for example cables, weights, etc.) is limited to the conditions stated by the supplier: all claims must be made in writing within eight days of the discovery of the defect and within 12 months of the delivery of the defective product. Munters has thirty days from the date of receipt in which to take action, and has the right to examine the product at the customer's premises or at its own plant (carriage cost to be borne by the customer).

Munters at its sole discretion has the option of replacing or repairing, free of charge, products which it considers defective, and will arrange for their despatch back to the customer carriage paid. In the case of faulty parts of small commercial value which are widely available (such as bolts, etc.) for urgent despatch, where the cost of carriage would exceed the value of the parts, Munters may authorise the customer exclusively to purchase the replacement parts locally; Munters will reimburse the value of the product at its cost price.

Munters will not be liable for costs incurred in demounting the defective part, or the time required to travel to site and the associated travel costs. No agent, employee or dealer is authorised to give any further guarantees or to accept any other liability on Munters' behalf in connection with other Munters products, except in writing with the signature of one of the Company's Managers.

WARNING: In the interests of improving the quality of its products and services, Munters reserves the right at any time and without prior notice to alter the specifications in this manual.

The liability of the manufacturer Munters ceases in the event of:

- dismantling the safety devices;
- use of unauthorised materials;
- inadequate maintenance;
- use of non-original spare parts and accessories.

Barring specific contractual terms, the following are directly at the user's expense:

- preparing installation sites;
- providing an electricity supply (including the protective equipotential bonding (PE) conductor, in accordance with CEI EN 60204-1, paragraph 8.2), for correctly connecting the equipment to the mains electricity supply;
- providing ancillary services appropriate to the requirements of the plant based on the information supplied with regard to installation;
- tools and consumables required for fitting and installation;
- lubricants necessary for commissioning and maintenance.

It is mandatory to purchase and use only original spare parts or those recommended by the manufacturer. Dismantling and assembly must be performed by qualified technicians and according to the manufacturer's instructions.

The use of non-original spare parts or incorrect assembly exonerates the manufacturer from all liability.

Requests for technical assistance and spare parts can be made directly to the nearest [Munters office](#).

