

# DSS Pro™ Dehumidification system

---

Operating manual

T-DSS-D2206

Copyright © 2022 Munters Europe AB

Original instructions



**IMPORTANT**

Read these instructions before using the product.

## Table of Contents

1. Introduction .....	5
1.1. Definition .....	5
1.2. About this manual .....	5
1.3. Copyright .....	5
1.4. Safety information .....	5
1.5. Warranty .....	6
1.6. Identification .....	6
1.7. Technical specifications .....	7
1.8. Unintended use .....	7
1.9. Operation monitoring .....	7
2. Safety .....	8
2.1. Intended use .....	8
2.2. Safety .....	8
2.3. Residual risks .....	9
2.4. Warning signs .....	10
2.5. Door opening .....	11
3. Transport, delivery inspection and storage .....	12
3.1. Lifting .....	12
3.2. Delivery inspection .....	12
3.3. Storage .....	12
4. System design and function .....	13
4.1. Main function .....	13
4.2. System design .....	13
4.3. Pre- and post-treatment .....	15
5. Main components description .....	16
5.1. Desiccant rotor .....	16
5.2. Reactivation heater .....	17
5.2.1. General .....	17
5.2.2. Electric reactivation .....	17
5.2.3. Steam reactivation .....	17
5.2.4. Gas fired reactivation .....	17
5.3. Purge systems .....	18
5.3.1. ERP (Energy Recovery Purge) .....	18
5.3.2. EULD (EU Low Dew point Purge) .....	18
5.3.3. PowerPurge™ and Green PowerPurge™ .....	19
5.4. Fluid coils .....	19
5.4.1. Product description .....	19
5.4.2. Droplet separator .....	20
5.5. Electric heater .....	20
5.6. Humidifier .....	20
5.7. Process fan .....	21
5.8. Reactivation fan .....	22
5.9. Air filters .....	22
5.10. Dampers .....	23
6. Operation .....	24
6.1. Operator panel .....	24
6.2. Control system .....	24
6.3. HMI and Ethernet connection .....	25
6.4. Start the unit .....	25
6.5. Stop the unit .....	26
7. Service and maintenance .....	27
7.1. Safety .....	27
7.2. General .....	27

---

7.3. Extended warranty .....	27
7.4. Service alternatives .....	28
7.5. Maintenance schedule .....	29
7.6. Cleaning .....	31
8. Disposal .....	32
9. Supplements .....	33
10. Contact Munters .....	34

# 1. Introduction

## 1.1. Definition

The dehumidification system DSS Pro™ (Desiccant System Solution) described in this manual is hereafter referred to as the “unit”.

## 1.2. About this manual

This manual contains important safety information, a product description and maintenance instructions for the delivered dehumidification system.

This manual does not describe in full all the maintenance work required to guarantee the longevity and reliability of this type of equipment. Always contact Munters for service and repairs, to ensure safe and long lasting operation of the unit.

This manual should be read together with the unit standard supplements and order specific documentation. See section *Supplements* for an overview.

Transportation and lifting instructions are available in the supplemental *Installation instructions*.

This manual must be stored in a permanent location close to the unit.

## 1.3. Copyright

The contents of this manual can be changed without prior notice.



### NOTE

This manual contains information which is protected by copyright laws. It is not allowed to reproduce or transmit any part of this manual without written consent from Munters.

Munters Europe AB, P.O. Box 1150, SE-16426 KISTA Sweden

## 1.4. Safety information

Information about dangers are in this manual indicated by the common hazard symbol:



### WARNING

Indicates a possible danger that can lead to personal injury.



### CAUTION

Indicates a possible danger that can lead to damage to the unit or other property, or cause environmental damage.



**NOTE**

Highlights supplementary information for optimal use of the unit.

### 1.5. Warranty

The warranty is based on the terms of sale and delivery of Munters. The warranty is not valid if repairs or modifications are carried out without the written agreement of Munters, or if the unit does not operate under the conditions agreed with Munters.

The energies supplied (electricity, gas etc.) must be as specified for the unit.

The warranty is limited to a free exchange of parts or components which have failed as a result of defects in materials or workmanship.

All warranty claims must include proof that the fault has occurred within the warranty period and that the unit has been used in accordance with the specifications. All claims must specify the unit type and serial number. This information is stamped on the identification label.

Commissioning/Start-up inspection "S" by Munters is mandatory to validate the full warranty. See the maintenance schedule in section *Service and maintenance*.

It is a condition of the warranty that the unit for the full warranty period is serviced and maintained by a qualified Munters engineer or Munters approved engineer. The service and maintenance must be documented for the warranty to be valid.

### 1.6. Identification

MUNTERS **DSS Pro** System ID

Project ref. name

Order no.

Unit Model

Object ID

Prod. date

Genesisys no.

Air Flow	Process		React	
<input type="text"/>	Sm <sup>3</sup> /h	<input type="text"/>	Sm <sup>3</sup> /h	
Pressure ESP	<input type="text"/>	Pa	<input type="text"/>	Pa

Motor rating  +  kW

Full load current  +  FLA A

Power supply  V / PH / Hz

System weight (operational)  kg

Manufactured by

**Munters**  
Munters Europe AB  
Na Aleji 570  
69156 Hrusky, Czech Republic

For more info  
Scan here

MUNTERS **DSS Pro** Electrical ID

Project ref. name

Order no.

Unit Model

Object ID

Prod. date

Genesisys no.

Electrical cabinet

**ELECTRICAL DATA**

Voltage	<input type="text"/> V	Max Current	<input type="text"/> Amps
Phases	<input type="text"/>	Max Power	<input type="text"/> kW
Frequency	<input type="text"/> Hz	Prel. fuse max	<input type="text"/> Amps
Control voltage	<input type="text"/> VDC/VAC	Process fan(s)	<input type="text"/> kW
Lighting voltage	<input type="text"/> V <sub>max</sub>	React + PP fan(s)	<input type="text"/> kW
Icu	<input type="text"/> kAmps	React heater	<input type="text"/> kW

Manufactured by

**Munters**  
Munters Europe AB  
Na Aleji 570  
69156 Hrusky, Czech Republic

For more info  
Scan here

*Each unit is foreseen with a System ID plate and an Electrical ID plate, which together is the system identification.*



The individual modules (blocks) and control cabinet(s) have their own ID. Additional stickers give specific information.

The object ID is the unique identification number of the unit, which is a combination of base part number and serial number. Please use this number when contacting Munters service.

## 1.7. Technical specifications

The technical specifications for the unit can be found in the order specific documentation.

## 1.8. Unintended use

- The unit is not intended for use in classified areas where explosion safety compliant equipment is required.
- The unit must not be installed near any heat generating devices that can cause damage to the equipment.
- The unit is not intended for treating air polluted with solvents, acids, bases or substances with a high boiling point. Dust or other aggressive, corrosive or abrasive particles must also be avoided.

## 1.9. Operation monitoring

The dehumidifier is controlled and monitored from the operator panel that is located in a separate control cabinet that must be placed in sight near the unit. The control system panel is used to display values and parameters, and to input settings and commands to the control system. As standard a wired plug-in handheld HMI with display is included in the unit delivery.

## 2. Safety

### 2.1. Intended use

The unit delivered by Munters must only be used for the treatment of air. This includes filtering, heating, cooling, humidifying, dehumidifying and transporting air.

No modification of the unit is allowed without prior approval by Munters, will cause loss of CE/UKCA certificate. Installation of additional devices is only allowed after written agreement by Munters.

The conditions of operation specified in the technical specifications must be observed.

### 2.2. Safety

The information in this manual shall in no way take precedence over individual responsibilities or local regulations.

During operation and other work with a machine it is always the responsibility of the individual to consider:

- The safety of all persons concerned.
- The safety of the unit and other property.
- The protection of the environment.



#### WARNING

- All electrical installations must be done by an authorized electrician in accordance with local regulations. An incorrect installation can cause electrical shock hazards and damage to the unit.
- The unit must never be connected to another voltage or frequency than what is specified on the identification plate. Too high line voltage can cause electrical shock hazards and damage to the unit.
- Rotating fan blades can cause serious injury. Only operate the unit with the air ducts connected.
- The unit can restart automatically after a power cut. Make sure that the main power switch is set and locked in the OFF position before any service or maintenance work starts.
- Use only approved lifting equipment to prevent personal injury and damage to the unit.
- Move the unit carefully to prevent it from overturning.
- There is a fire hazard, or risk of unit malfunction, if filters are maintained insufficiently or incorrectly.
- When working with filters or in a dusty area: To protect the user from dust, wear a suitable CE marked face mask selected and fitted in accordance with the applicable safety standards.
- If the rotor is to be cut in pieces, wear a suitable CE marked face mask selected and fitted in accordance with the applicable safety standards to protect from the dust.



**NOTE**

It is recommended to contact Munters for service or repair. Operating faults can occur if the unit is maintained insufficiently or incorrectly.

## 2.3. Residual risks

In order to avoid the possible dangers in operating or maintaining the unit, necessary protections have been foreseen. However, there are still some residual risks that all personnel working with the unit must be aware of:

The handling of fluids in refrigerating, heating or cooling circuits can be dangerous. Study the information relevant for each type of fluid to avoid dangers.

Hot or cold surfaces can cause injuries. Before intervening, wait until temperatures become normal or use protective clothing.

When working inside the unit, pay attention to the possible ergonomic dangers from inadequate work positions or heavy lifts.

Unit sections can be high. Use secure scaffolding to access the upper level.

Unit panels can be heavy. Do not handle alone.

Sharp steel edges on boxes or coils can cause cuts. Use protective gloves, particularly during disassembly or assembly.

There is a fire hazard, or risk of unit malfunction, if filters are maintained insufficiently or incorrectly.

Cleaning agents, cooling media, oil and grease are substances that are dangerous to personal health and to the environment. They must not be allowed to drain away into the soil or the public sewer system. Such substances must be disposed of in accordance with local and national law and regulations.

When working with or near fans, be aware that remaining air flow through the unit can cause spontaneous rotation of the fans and thereby causing personal injury.

Doors for overpressure compartments can be equipped with additional safety locks against accidental opening. Make sure that such locks are closed before starting the unit.

When working with filters or in a dusty area: To protect the user from dust, wear a suitable CE marked face mask selected and fitted in accordance with the applicable safety standards.

Use hearing protection according to applicable safety standards when working in a noisy environment to avoid hearing impairment.

Dampers open and close automatically. Keep hands clear of the dampers when they are moving.

## 2.4. Warning signs

The following warning signs can be present on the unit, to warn the users of residual risks which can cause serious injury. Make sure that all personnel working with or near the unit are aware of the meaning of each sign.

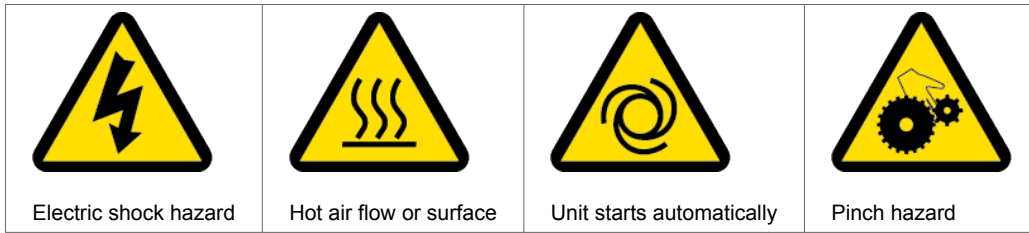

## 2.5. Door opening

Follow the directions beside the handle to open.

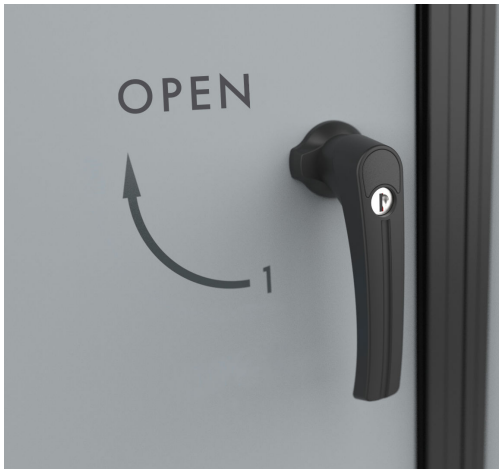

*Normal door*

Doors for over pressure sections have a built-in protection against unintended opening.



*Over pressure section door*

## 3. Transport, delivery inspection and storage

### 3.1. Lifting

Lifting instructions are found in the Installation instructions supplement for the product.

### 3.2. Delivery inspection

Do an inspection of the delivery and compare with the delivery note, order confirmation or other delivery documentation. Make sure that everything is included and nothing is damaged.

Contact Munters within 3 days if the delivery is not complete or damaged in order to avoid installation delays.

If damaged:

- Any damage to the packaging must be documented with photos before the packaging is removed.
- Remove all packaging material from the unit, and make sure that no damage has been made during transportation.
- Any damage to the unit must be documented with photos.
- Any visible damage must be reported in writing to Munters within 3 days and prior to installation of the unit.

### 3.3. Storage

The unit should before installation be stored under a protective cover. Ideally it should remain in its sealed transport packaging.

If for some reason the unit was already unpacked, follow these instructions to prevent damage, corrosion and / or deterioration:

- Place the sections in an upright position on a horizontal surface.
- Protect the sections from physical damage.
- Store the sections under protective cover, close openings and protect them from dust, heat, frost, rain and aggressive contaminants.
- In the case of long term storage, manually rotate the motors, fans and pumps regularly to prevent the bearings from seizing.

## 4. System design and function

### 4.1. Main function

The DSS Pro-series is a rotor based desiccant dehumidifier system designed to efficiently dehumidify the air in environments requiring low air humidity. All components like fans, filters and coils can be configured to fit the requested application. A wide range of standardized components is selectable but special designs are also possible to ensure Munters DSS Pro is the best fit for your application. The total system is balanced in component selection and everything is designed to operate as energy efficiently as possible.

The system is set up and operated from the operator panel. Wall sensors or duct sensors measure the temperature and humidity of the process air. The control system and electrical safety functions for all the components are placed in the electrical panel.

All components are regulated proportionately and configured to achieve optimal capacity and energy usage. The supply air fan is set to run continually to ensure precise climate control. Regulation can be time controlled on a weekly, monthly and stipulated full-day basis as well as winter/summer periods with specific operational temperature and humidity settings. Several possibilities exist for connecting to building management systems for controlling and monitoring the functions. Contact Munters for more information on automatic systems or bus connections.

### 4.2. System design



#### NOTE

Some components are optional, and systems are built to individual specifications.

Munters Block Philosophy means that Munters DSS Pro is designed in an intuitive, easy to manage way. Rather than one large unit. Munters DSS Pro is split into individual blocks which fit seamlessly together to form the whole solution. This philosophy means that delivery is easier, and installation is smoother and more efficient.

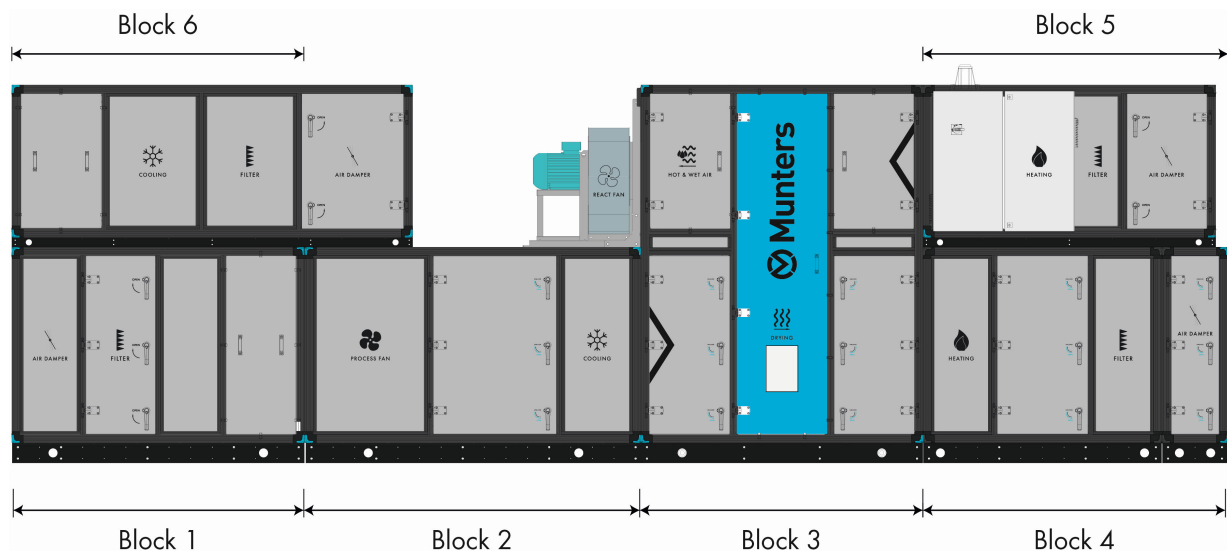

The functional breakdown of the unit is:

- Pre-treatment
- Dehumidification
- Post-treatment
- Reactivation

Incoming process air can be pre-treated in order to create the desired operational conditions for the dehumidification process.

Post-treatment of the dry air is sometimes required in order to meet the supply dry air specification.

Examples of pre- and post-treatment components are filters for both coarse and fine particles, and a heater and/or cooler for temperature control of the supply air.

Dehumidification follows after the pre-treatment.

It contains a rotor box unit with the desiccant rotor and rotor drive system.

Examples of available options are face and by-pass dampers to control part of the incoming process air flow past the rotor, or a purge sector of the rotor after reactivation in order to further optimize the dehumidification performance of the unit.

The process fan(s) are driven by electric motors that can be controlled by frequency converters for capacity modulation. The fan(s) can be placed either in the pre-treatment or in the post-treatment module.

Reactivation of the rotor is carried out in a separate reactivation module, which comprises a heater and a fan to pull the heated air through the rotor in the opposite direction to the process air flow.

All units have a separately installed electrical panel for the electrical control equipment, and an operator panel for controlling and monitoring the air treatment process.

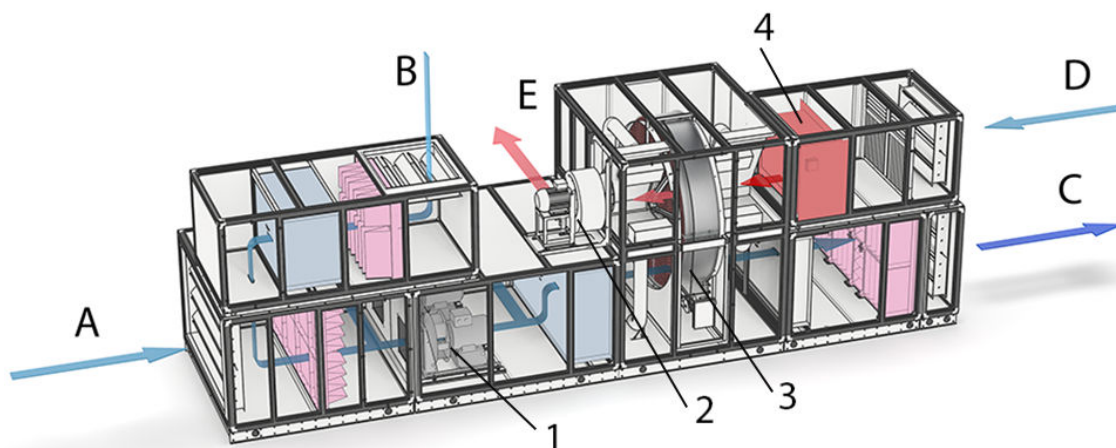

1.	Process fan	A.	Return air
2.	Reactivation fan	B.	Outdoor air
3.	Dehumidification rotor	C.	Supply air
4.	Reactivation heater	D.	Reactivation air
		E.	Wet air

### 4.3. Pre- and post-treatment

The following functional components can be used for pre- and post-treatment of the process air:

- Inlet dampers to enable isolation of the unit from the air flow.
- A mixing box allowing mixing fresh air with recirculation air.
- Heating coil: The coil can be electric or use hot water as heating medium. In the case of hot water, the coil must be connected to an external heating medium supply.
- Cooling coil: The coil uses chilled water, possibly mixed with glycol. The coil must be connected to an external medium supply.
- Humidification by evaporation or steam injection in order to achieve the process air quality specification during dry ambient conditions. See the humidifier supplement.
- Filters for various air quality specifications. Filters can be equipped with pressure drop sensors to enable "blocked filter" alarm.

## 5. Main components description



### NOTE

Some components are optional, and systems are built to individual specifications.

### 5.1. Desiccant rotor

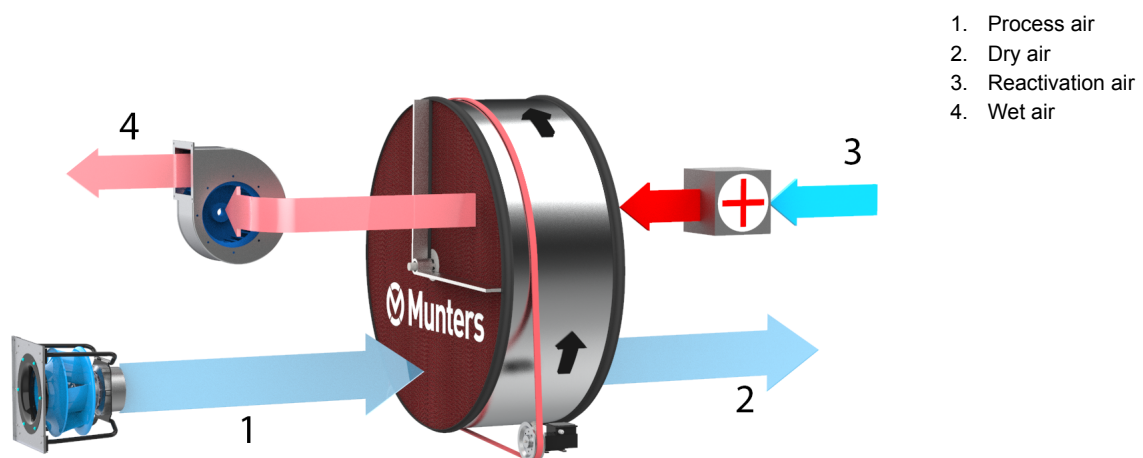

The desiccant rotor is the adsorption dehumidifying component in the unit. The rotor structure is comprised of a large number of small air channels.

The desiccant rotor is made of a composite material that is highly effective in attracting and retaining water vapour. The rotor is divided into zones.

The airflow to be dehumidified, **process air**, passes through the largest zone of the rotor and then leaves the rotor as **dry air**. Since the rotor rotates slowly, the incoming air always meets a dry zone on the rotor, thus creating a continuous dehumidification process.

The airflow used to dry the rotor, **reactivation air**, is heated. The reactivation air passes through the rotor in the opposite direction to the process air and leaves the rotor as **wet air** (warm, moist air).

This principle enables the dehumidifier to work effectively, even at freezing temperatures.

The rotor is monitored by a rotation sensor to enable an alarm if the rotor stops unintentionally.

#### Rotor maintenance

The rotor surface must be inspected regularly. Perform pressure drop measurements to follow rotor aging.

The desiccant rotor will not be replaced preventively, capacity monitoring will indicate when rotor replacement is necessary.



## 5.2. Reactivation heater

### 5.2.1. General

The reactivation air is heated to obtain the required temperature to reactivate the rotor. The heated air is pulled through the rotor reactivation sector by the reactivation fan to remove the moisture content. The reactivation air temperature is controlled as a function of the required dehumidification capacity.

The reactivation heating equipment can be comprised of an electrical heater, a steam heater or a direct fired gas burner unit depending on the availability at the installation site. The reactivation heater is used to heat outdoor air to the required reactivation air temperature.

### 5.2.2. Electric reactivation

For units with electric reactivation, the heater is controlled from the control system to regulate the dehumidification.

The electrical power supply to the reactivation heater needs to be connected directly to the heater itself. The heater has its own switching system.

### 5.2.3. Steam reactivation

For units with steam reactivation, all information concerning steam reactivation can be found in the separate Steam heating Supplement.

### 5.2.4. Gas fired reactivation

For units with gas fired reactivation, the gas heating system is based on a Low NOx direct fired combustion burner operating on natural gas or on special request on propane/LPG. The burner uses the fresh reactivation air to supply the oxygen necessary for combustion.

All information concerning gas fired reactivation can be found in the separate Gas Supplement.

### 5.3. Purge systems

Purge is an optional function, used to increase system dehumidification performance.

#### 5.3.1. ERP (Energy Recovery Purge)

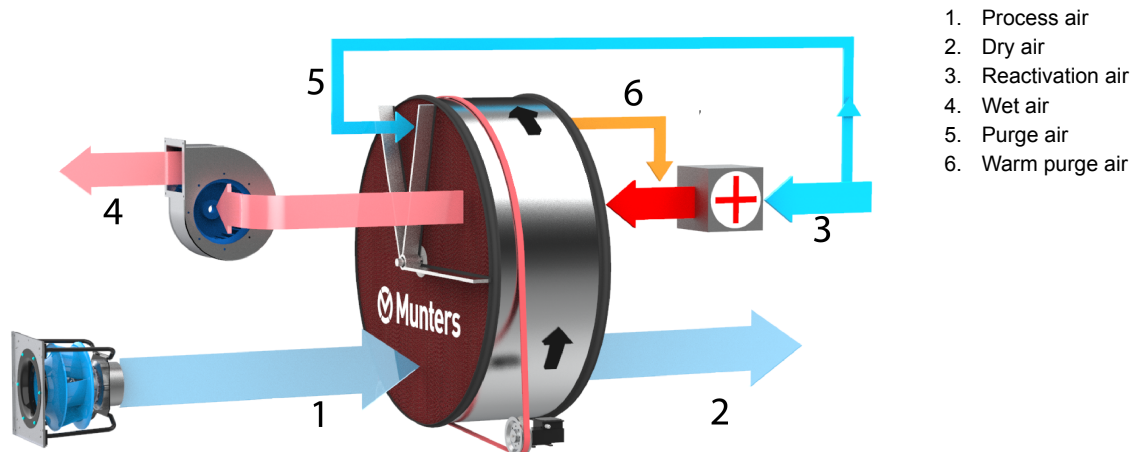

Compared to a standard unit, ERP will give the same dehumidification capacity with reduced reactivation heater energy.

A small part of the reactivation air passes the purge sector in order to cool down the rotor before it turns into the process sector. This procedure increases the adsorption capacity of the rotor and recovers some energy.

The heated purge air will be mixed with the reactivation inlet air to reduce the needed reactivation power.

#### 5.3.2. EULDP (EU Low Dew point Purge)

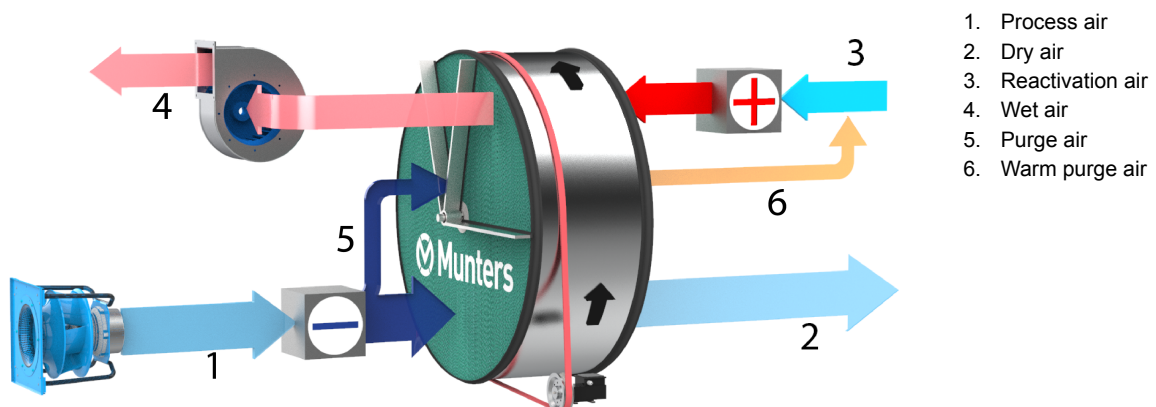

Low Dewpoint Purge (LDP) is used to enable extra low dewpoints. A minor part of the process airflow is forced through a smaller sector of the rotor which, according to the rotor rotation direction, is positioned directly after the reactivation sector. The result is that a part of the process air is taken off (purge air) and the rotor material is cooled down before it is exposed to the dry air outlet sector.

The warm purge airflow which is drawn from the smaller sector of the rotor passes an adjustable damper and enters the reactivation air just before the reactivation heater. This makes drying of the rotor more efficient.

### 5.3.3. PowerPurge™ and Green PowerPurge™

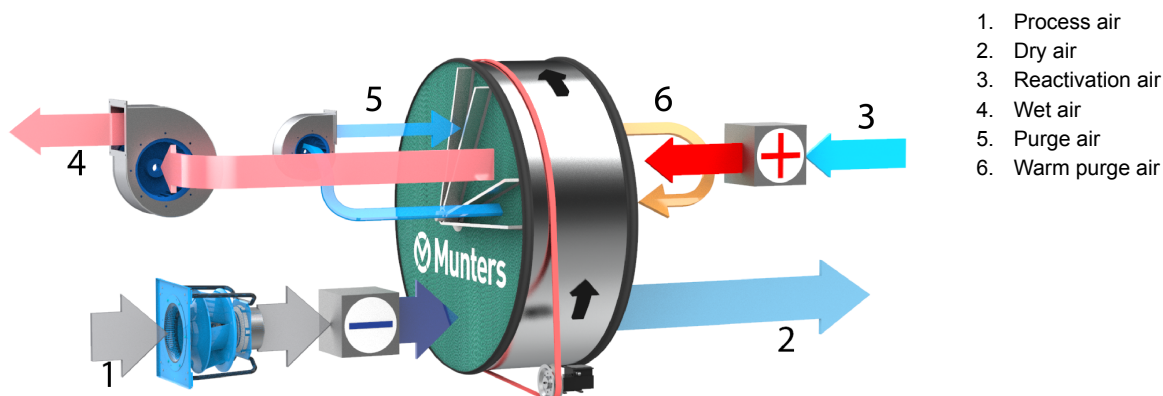

PowerPurge saves energy in two ways. The unique patented PowerPurge acts as an energy recovery system, collecting waste heat off the hottest section of the rotor and using it to preheat the desiccant before the reactivation sector.

A closed loop purge system provides a cooling purge to reduce post cooling needs and improve moisture removal. It then recycles this removed heat in a heating purge to reduce reactivation energy requirements.

## 5.4. Fluid coils

### 5.4.1. Product description

The unit can have fluid coils for cooling and heating. The cooling or heating is only regulated if the supply air fan is running.



#### CAUTION

If there is a risk of freezing when untreated outside air is used, an anti freeze medium like Glycol is recommended, or a frost protection monitor sensor must be fitted. The coils in the unit can be seriously damaged if this is not done.

Units with hot water coils can be delivered with an insertion connection for the frost sensor. If there is a risk of freezing, the sensor must be fitted and connected according to the wiring diagram for the unit. There can be a risk of freezing if the air is taken directly from outside.

If the water in a coil freezes this could cause serious damage. A frozen coil must almost always be replaced. The warranty is no longer valid even if the cracks are not visible.



#### CAUTION

Hot and cold water supply lines must only be designed and executed by qualified personnel taking local regulations into account .

The fluid properties must be according to specifications and must never exceed the design limits.

All piping connections must be fitted stress free to the unit, in case this cannot be prevented additional vibrations or expansion fittings should be used.

### 5.4.2. Droplet separator

All coolers are foreseen with drip tray. Condensing cooling coils can be equipped with a droplet separator to catch, collect and discharge condensate.

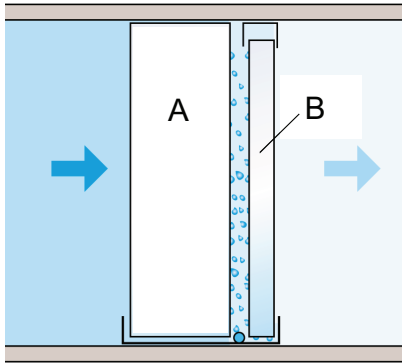

The droplet separator is built from a patented multi-plane-fluted pad that is set at an angle to the flow of air.

The water droplets are separated and transported down through the material to the drainage section.



#### CAUTION

Condensate drains must be foreseen with a non return trap, so called ball siphon. For more details, see the supplemental Installation instructions.

## 5.5. Electric heater

All electric heaters have minimally two high temperature cut-outs, an automatic resetting function and can be manually reset. The high temperature cut-out can be reset on the cover of all the electric heaters.

The electric heater power is produced on a time basis using pulse-pause technology. When heat is required the regulation equipment signals for full power (pulse) for a set time, depending on the heat requirement. If the heat requirement increases, the pulse time increases and the pause time decreases. When the heat requirement is reduced, the pulse time decreases and the pause time increases.

## 5.6. Humidifier

Humidifiers are used as needed to achieve the process air quality specification.

Units can be equipped with either an evaporative humidifier or a steam humidifier.

For more information about humidifiers if applicable, see the separate documentation.

## 5.7. Process fan

Plug fans with direct drive free running impellers are used as process fans.

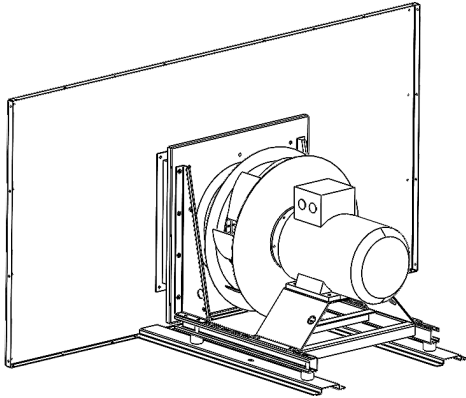

*Plug fan*

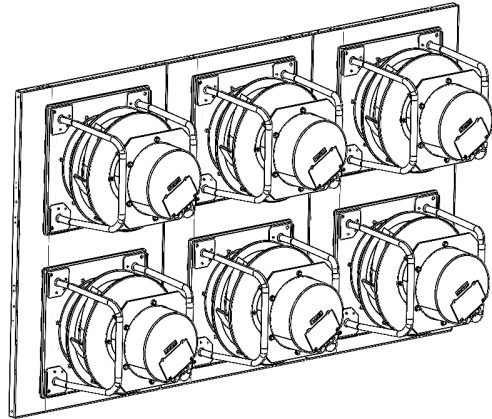

*Fan wall*



### **WARNING**

Rotating fan blades can cause serious injury.

Make sure that the main power switch is set and locked in the OFF position before starting any service or maintenance work.

The fan is driven by an electric motor which is controlled by a frequency converter. This makes it possible to adjust the air pressure and air flow from the operator panel to achieve the external pressure requirement.

For specific information about the fan, contact Munters.

## 5.8. Reactivation fan

The reactivation fan is a scroll type fan with direct drive impeller where the motor is positioned outside the hot and wet reactivation airflow.

The reactivation fan can have its outlet upwards or to the side.

Fans with upward outlet will be equipped with a drain (A) for wet air condensate.

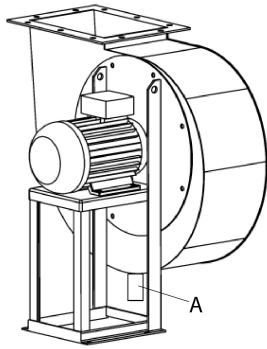

*Upward outlet*

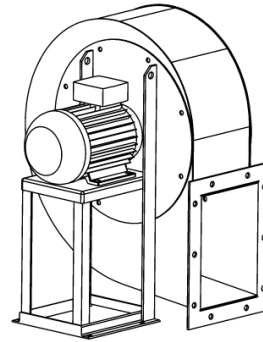

*Side outlet*

## 5.9. Air filters

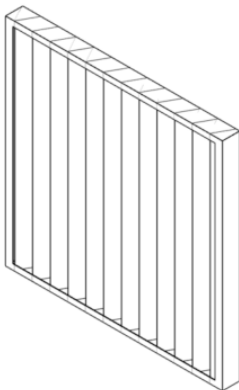

*Panel filter*

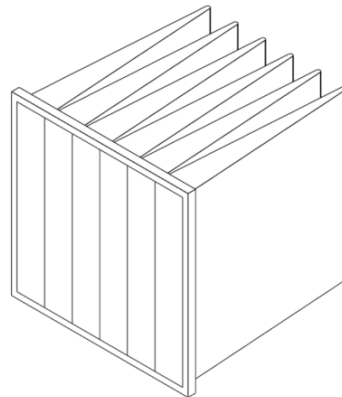

*Bag filter*

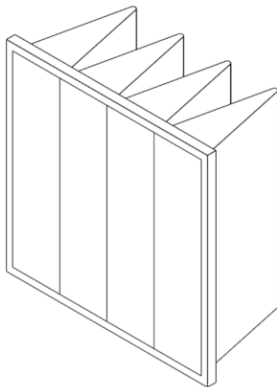

*Compact filter*

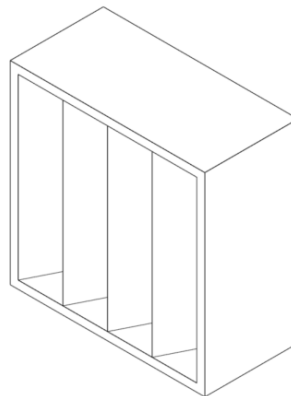

*Box filter*

**WARNING**

There is a fire hazard, or risk of unit malfunction, if filters are maintained insufficiently or incorrectly.

When working with filters or in a dusty area: To protect the user from dust, wear a suitable CE marked face mask selected and fitted in accordance with the applicable safety standards.

The filters require regular replacement. The frequency depends on the amount of dust in the air and the operating conditions.

Blocked filters can reduce the air flow in the unit. Incorrect air flow will reduce the capacity and the energy efficiency of the unit.

Examine the degree of dirt accumulation by measuring the differential pressure or by inspecting the filters visually.

A filter monitor will activate an alarm if the pressure drop across the filter is too great.

The permitted pressure drop setpoint is set by Munters at the factory. If the filter classifications are changed, adjust the setpoint to suit the new filter.

Replace the filters when:

- Final pressure drop is reached.
- There is a filter alarm.
- The filter is damaged and air is passing without filtration.

Clean the filter section, make sure that there is no dirt beyond the filter.

Make sure that the frames are sealed and if necessary replace the seals.

Replace the filter and make sure that there is no air leakage.

## 5.10. Dampers

Dampers are optional and can be used to open and close the inlet and the outlet of the unit, as well as for controlling bypass and recirculation.

Any air dampers not connected to a duct must be fitted with a protective grille (not included in the delivery from Munters) to prevent injury from the damper blade movement.

**WARNING**

Dampers open and close automatically. Keep hands clear of the dampers when they are moving.

## 6. Operation



### WARNING

Installation and commissioning must be done as described in the supplemental Installation instructions.

### 6.1. Operator panel

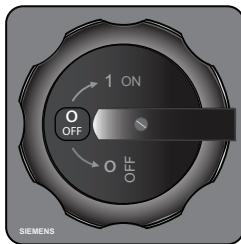

Main power switch

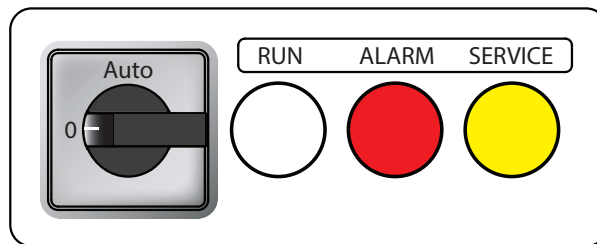

Operator panel

- When the main power switch is set to position **0**, the unit is not powered beyond the switch.
- When the main power switch is set to position **1**, the unit is powered and can be started.
- A main power switch with integrated fuse function must be reset by turning the knob to the bottom left position if it has tripped.
- When the mode selector is set to position **AUTO**, the dehumidifier is controlled to an internal adjustable humidity setpoint, or via an external input signal.
- RUN lamp, white, comes on when one of the fans is running.
- ALARM lamp, red, comes on when an alarm has been triggered.
- SERVICE lamp, yellow, comes on when a filter replacement is required, or when the time for next service is reached.

**Remote start/stop:** If remote start/stop is connected, the mode selector must be set to position AUTO in order to run the unit.

**External control:** If the unit is regulated via an external signal, the fans and drive motor start when the "remote start" switch is closed, regardless of the present humidity. In order to operate the unit, the external signal must be >1 V. The reactivation heater is regulated via the input signal.

### 6.2. Control system

For more information about the control system, parameters and settings, see the control system supplement.



### 6.3. HMI and Ethernet connection

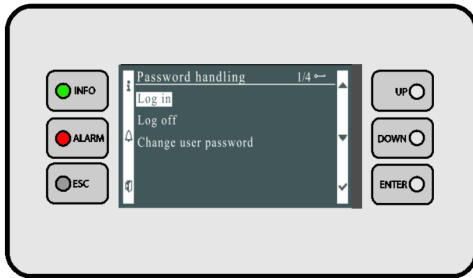

HMI - Human Machine Interface

Connectors for the **HMI** and for external communication are located on the outside of the control cabinet. For more details we refer to the supplementary Munters Control System instructions and electrical drawing that are part of the order specific documentation.

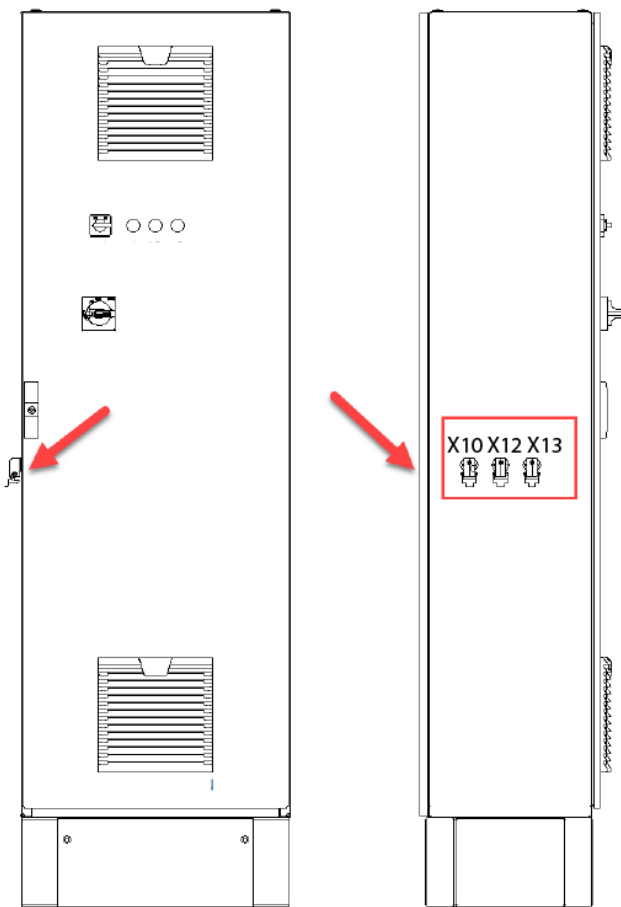

Connectors on control cabinet

X13	HMI
X12	Optional, Communication Modbus TCP/IP
X10	Optional, Communication BACNet

### 6.4. Start the unit

1. Make sure that all supplies of electricity and hot/cold water are on and functional.
2. Set the main power switch to **1** (ON).
3. Set the mode selector on the operator panel to **AUTO**.

## 6.5. Stop the unit

To stop the unit, set the mode selector on the operator panel to **0**.

When the unit is stopped with the mode selector all the functions in it are stopped apart from freeze monitoring.

### Emergency stop

The main power switch is also used as emergency stop function. It should only be used in case of emergency and not as normal start / stop as this can lead to uncontrolled damage of the system.



### CAUTION

In order to dissipate any residual heat, the fans and the drive motor continue to run after the unit is switched off until the temperature falls below 50 °C. Do not turn off the main power before the fans have come to a complete stop.



### NOTE

If the unit is to be out of operation for a longer time, close all shut-off valves of the fluid and steam supplies. Make sure all coils are drained so they cannot freeze during standstill.

Set the main power switch to OFF.

The freeze monitoring is disabled.

## 7. Service and maintenance

### 7.1. Safety



#### **WARNING**

The unit can restart automatically after a power cut. Make sure that the main power switch is set and locked in the OFF position before any service or maintenance work starts.



#### **WARNING**

Rotating fan blades can cause serious injury. Only operate the unit with the air ducts connected.

### 7.2. General

Service and maintenance interval lengths are primarily determined by operating conditions and the environment in which the unit is installed. For example, if the process air contains a lot of dust, preventative maintenance should be carried out at shorter intervals. The same also applies if the unit works intensively.

The control system is equipped with a service indicator. It is programmed at commissioning to give a service alarm after an estimated number of operating hours, or on the preset date for the next service.

Munters offers a comprehensive range of services, from commissioning and start-up to advanced maintenance packages. More information can be obtained from the local Munters representative.

### 7.3. Extended warranty

Munters offers an extended warranty to the standard terms when the Customer signs a service agreement with Munters. Details are available on request.

## 7.4. Service alternatives

In addition to commissioning (**S**) of the unit there are four service alternatives (**A - D**) as standard.

**A** - Inspection and change of filters. General function inspection.

**B** - In addition to A, safety inspection and capacity, temperature and humidity regulation measurements.

**C** - In addition to B, preventive replacement of some components after 3 years of operation.

**D** - In addition to C, preventive replacement of some components after 6 years of operation.



### NOTE

It is recommended to contact Munters for service or repair. Operating faults can occur if the unit is maintained insufficiently or incorrectly.



### NOTE

Commissioning/Start-up inspection "S" by Munters is mandatory to validate the full warranty.

## 7.5. Maintenance schedule



### NOTE

Maintenance schedule is valid for standard system design operating in normal working conditions. Systems for low dew points or running in heavy duty conditions require an adapted maintenance schedule, consult Munters Service .

### 0 - 36 MONTHS, 0 - 24000 HOURS

Service alternative	S	A	B	A	B	A	C
Operating time [thousand hours]	0	4	8	12	16	20	24
Calendar time [months]	0	6	12	18	24	30	36
Filter Change, Operational check		X	X	X	X	X	X
General mechanical inspection Including vibration checks	X	X	X	X	X	X	X
Capacity monitoring full/partial load, Mechanical rotor inspection	X		X		X		X
<b>Electric reactivation:</b> Earth leak and power check heaters	X		X		X		X
<b>Steam reactivation:</b> Inspection steam coil and steam trap	X		X		X		X
<b>Gas reactivation:</b> Setup and maintenance gas burner	X		X		X		X
Check belt tension and rotation speed and rotation control sensor	X	X	X	X	X	X	X
Replacement rotor drive belt							X
Replacement rotor drive motor							X
Inspection process fan operation - Plenum type	X		X		X		X
Inspection Power purge fan, optional	X		X		X		X
Inspection react fan scroll type	X	X	X	X	X	X	X
Inspection pre-post handling boxes - door seals , coil drains and door locks	X						X
Check calibration humidity sensors - operation valves - SSR	X		X		X		X
Check calibration temp. sensors - operation valves - SSR	X		X		X		X
Check operation and settings frequency drives	X		X		X		X
Check Climatix control set up - Upgrade software	X		X		X		X
Inspection rotor seals and seal adjustment	X		X		X		X
Check damper operation and damper motors	X		X		X		X

**42 - 72 MONTHS, 28000 - 48000 HOURS**

<b>Service alternative</b>	<b>A</b>	<b>B</b>	<b>A</b>	<b>B</b>	<b>A</b>	<b>D</b>
<b>Operating time [thousand hours]</b>	<b>28</b>	<b>32</b>	<b>36</b>	<b>40</b>	<b>44</b>	<b>48</b>
<b>Calendar time [months]</b>	<b>42</b>	<b>48</b>	<b>54</b>	<b>60</b>	<b>66</b>	<b>72</b>
Filter Change, Operational check	X	X	X	X	X	X
General mechanical inspection Including vibration checks	X	X	X	X	X	X
Capacity monitoring full/partial load, Mechanical rotor inspection		X		X		X
<b>Electric reactivation:</b> Replacement HTCO Electric reactivation heater						X
<b>Electric reactivation:</b> Earth leak and power check heaters		X		X		X
<b>Steam reactivation:</b> Test HTCO for steam supply above 7 bar*						X
<b>Steam reactivation:</b> Inspection steam coil and steam trap		X		X		X
<b>Gas reactivation:</b> Replacement HTCO gas safety , double						X
<b>Gas reactivation:</b> Setup and maintenance gas burner		X		X		X
Check belt tension and rotation speed and rotation control sensor	X	X	X	X	X	X
Replacement rotor drive belt						X
Replacement rotor drive motor						X
Inspection process fan operation - Plenum type		X		X		X
Inspection Power purge fan, optional		X		X		X
Inspection react fan scroll type	X	X	X	X	X	X
Inspection pre-post handling boxes - door seals , coil drains and door locks						X
Check calibration humidity sensors - operation valves - SSR		X		X		X
Check calibration temp. sensors - operation valves - SSR		X		X		X
Check operation and settings frequency drives		X		X		X
Check Climatix control set up - Upgrade software		X		X		X
Replacement rotor seals						X
Inspection rotor seals and seal adjustment		X		X		X
Check damper operation and damper motors		X		X		X
* Valid for units with steam reactivation max 7 Bar						

**NOTE**

Replace the rotor only when a capacity measurement shows that it is necessary.

Service work should be performed at indicated operating hours or calendar time, whichever is reached first.

Maintenance schedule restarts again after service alternative D.

## 7.6. Cleaning

Use only a pH-neutral soapy water solution and a soft sponge for cleaning of the unit casing.

When cleaning the inside, avoid contact with the rotor and wipe the surfaces dry.

Use a vacuum cleaner with a brush head for the rotor. Contact Munters for instructions if vacuum cleaning is not sufficient.

## 8. Disposal

The unit and consumables must be disposed of in accordance with applicable legal requirements and regulations. Contact your local authorities.

If the rotor or filters have been exposed to chemicals that are dangerous to the environment the risk must be assessed. The chemicals can accumulate in the material. Take the necessary precautions to comply with applicable local legal requirements and regulations.

The rotor material is not combustible, and should be deposited like fiberglass materials.



### WARNING

If the rotor is to be cut in pieces, wear a suitable CE marked face mask selected and fitted in accordance with the applicable safety standards to protect from the dust.



Material type	Examples	In relation to weight	Presence
Steel	baseframe, panels, fan, electric motor, rotor structure and cassette	High	Always
Aluminium	casing structure, electric motor, coils, dampers	High	Always
Copper	coils, motor	Medium	Always
Stainless steel	panels, coils	High	Optional
Mineral wool	panels, sound attenuators	High	Always
Rubber	gaskets, shock absorbers, antivibration joints	Low	Always
Plastics	handles, claps, casing joints	Low	Always
Electronics	control system, electrical panel	Low	Always
Fibreglass paper	desiccant media, air filters	Low	Always



## 9. Supplements

### **Additional standard information**

Available in supplements to this manual as applicable.

- Product sheet
- Munters Control System instructions
- Installation instructions
- Gas reactivation
- Steam heating
- Humidification

### **Order specific documentation**

As built documentation for the individual unit.

- Technical specification
- Wiring diagram
- GA-drawing
- Spare parts list
- Declaration of conformity
- Test certificate

## 10. Contact Munters

Find your nearest Munters office at [www.munters.com](http://www.munters.com).

Click [here](#) or scan below to find your local Munters Service Team.





[www.munters.com](http://www.munters.com)

